



MMBTH10

NPN SILICON TRANSISTOR

RF TRANSISTOR

DESCRIPTION

The UTC **MMBTH10** is designed for using as VHF and UHF oscillators and VHF Mixer in a tuner of a TV receiver.

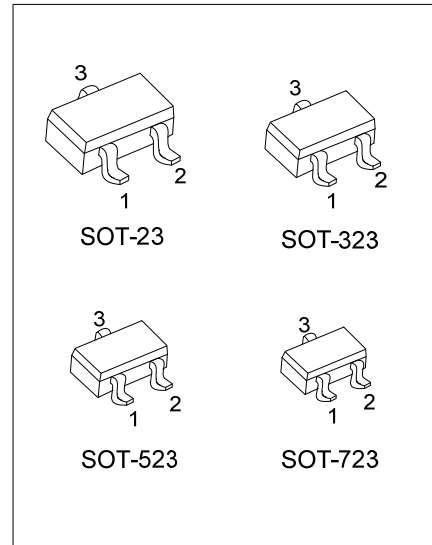

ORDERING INFORMATION

Ordering Number		Package	Pin Assignment			Packing
Lead Free	Halogen Free		1	2	3	
MMBTH10L-x-AE3-R	MMBTH10G-x-AE3-R	SOT-23	B	E	C	Tape Reel
MMBTH10L-x-AL3-R	MMBTH10G-x-AL3-R	SOT-323	B	E	C	Tape Reel
MMBTH10L-x-AN3-R	MMBTH10G-x-AN3-R	SOT-523	B	E	C	Tape Reel
MMBTH10L-x-AQ3-R	MMBTH10G-x-AQ3-R	SOT-723	B	E	C	Tape Reel

Note: Pin Assignment: B: Base E: Emitter C: Collector

<p>MMBTH10G-x-AE3-R</p> <p>(1) Packing Type (2) Package Type (3) Rank (4) Green Package</p>	<p>(1) R: Tape Reel (2) AE3: SOT-23, AL3: SOT-323, AN3: SOT-523 AQ3: SOT-723 (3) x: refer to Classification of h_{FE} (4) G: Halogen Free and Lead Free, L: Lead Free</p>
---	--

MARKING

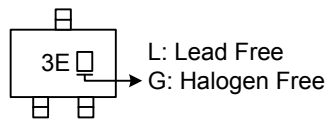

MMBTH10

NPN SILICON TRANSISTOR

■ ABSOLUTE MAXIMUM RATING ($T_A=25^{\circ}\text{C}$ unless otherwise specified)

PARAMETER	SYMBOL	RATINGS	UNIT
Collector-Base Voltage	V_{CB0}	30	V
Collector-Emitter Voltage	V_{CE0}	25	V
Emitter-Base Voltage	V_{EB0}	3	V
Power Dissipation	SOT-23	225	mW
	SOT-323/SOT-523	200	mW
	SOT-723	150	mW
Collector current	I_C	50	mA
Junction Temperature	T_J	+150	$^{\circ}\text{C}$
Storage Temperature	T_{STG}	-55 ~ +150	$^{\circ}\text{C}$

Note: Absolute maximum ratings are those values beyond which the device could be permanently damaged. Absolute maximum ratings are stress ratings only and functional device operation is not implied.

■ ELECTRICAL CHARACTERISTICS ($T_A=25^{\circ}\text{C}$ unless otherwise specified)

PARAMETER	SYMBOL	TEST CONDITIONS	MIN	TYP	MAX	UNIT
Collector-Base Breakdown Voltage	BV_{CB0}	$I_C=100\mu\text{A}$	30			V
Collector-Emitter Breakdown Voltage	BV_{CE0}	$I_C=1\text{mA}$	25			V
Emitter-Base Breakdown Voltage	BV_{EB0}	$I_E=10\mu\text{A}$	3			V
Collector-Emitter Saturation Voltage	$V_{CE(SAT)}$	$I_C=4\text{mA}, I_B=400\mu\text{A}$			500	mV
Base-Emitter on Voltage	$V_{BE(ON)}$	$V_{CE}=10\text{V}, I_C=4\text{mA}$			950	mV
Collector Cut-off Current	I_{CBO}	$V_{CB}=25\text{V}$			100	nA
Emitter Cut-off Current	I_{EBO}	$V_{EB}=2\text{V}$			100	nA
DC Current Gain	h_{FE}	$V_{CE}=10\text{V}, I_C=4\text{mA}$	60			
Output Capacitance	C_{ob}	$V_{CB}=10\text{V}, f=1\text{MHZ}$			0.7	pF
Current Gain Bandwidth Product	f_T	$V_{CE}=10\text{V}, I_C=4\text{mA}, f=100\text{MHZ}$	650			MHz

■ CLASSIFICATION OF h_{FE}

RANK	A	B	C
RANGE	60-100	90-130	120-200

TYPICAL CHARACTERISTICS

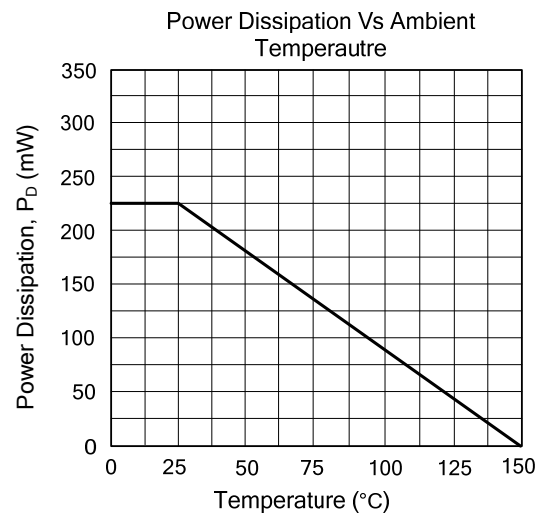
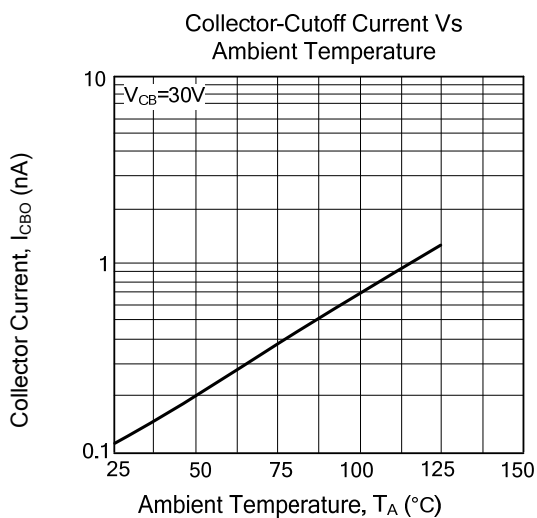
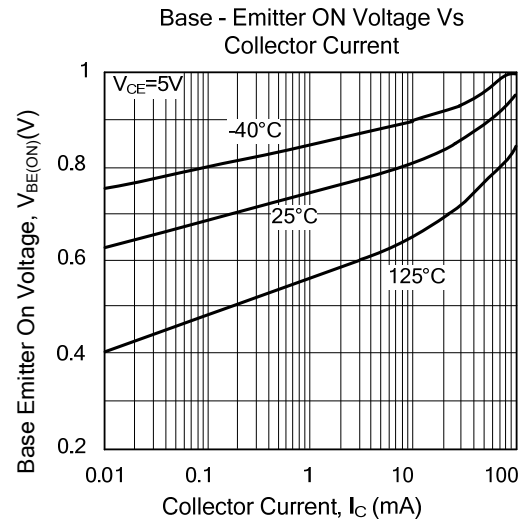
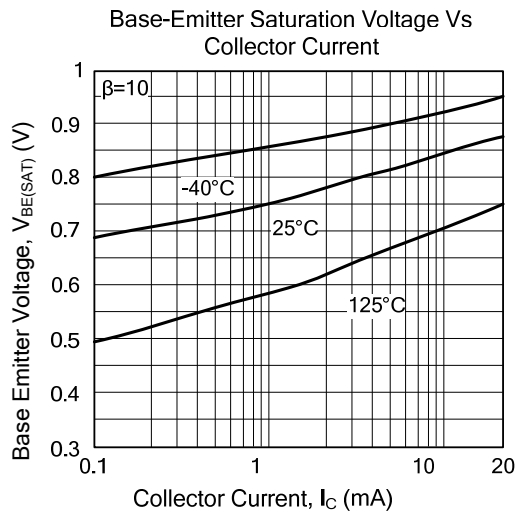
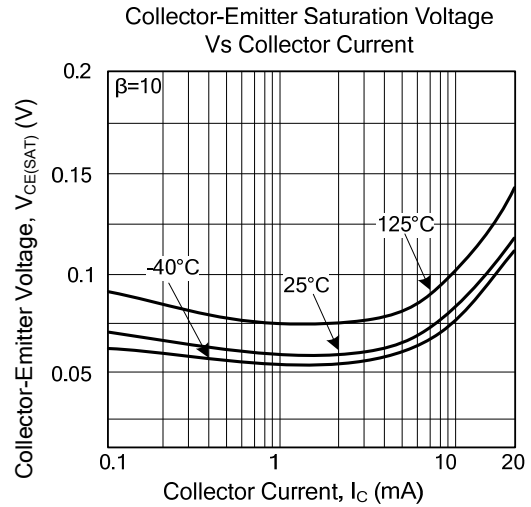
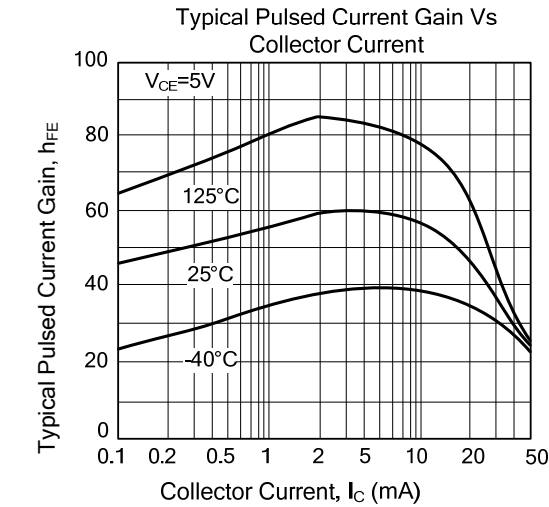

■ TYPICAL CHARACTERISTICS (Cont.)

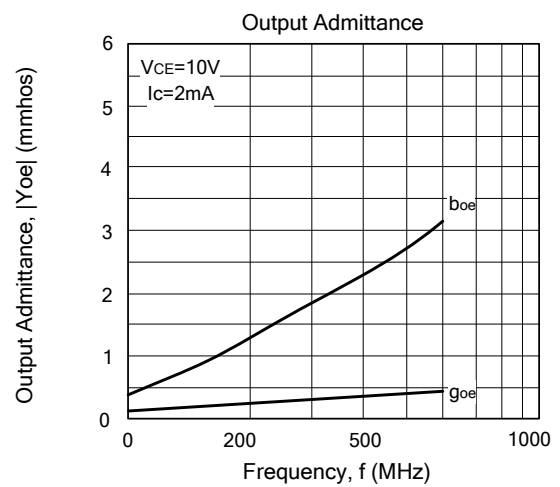
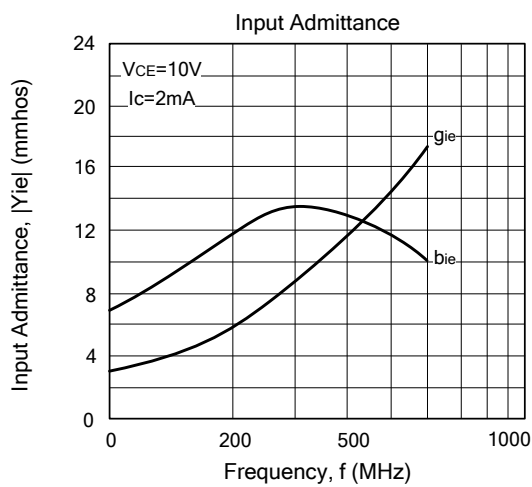
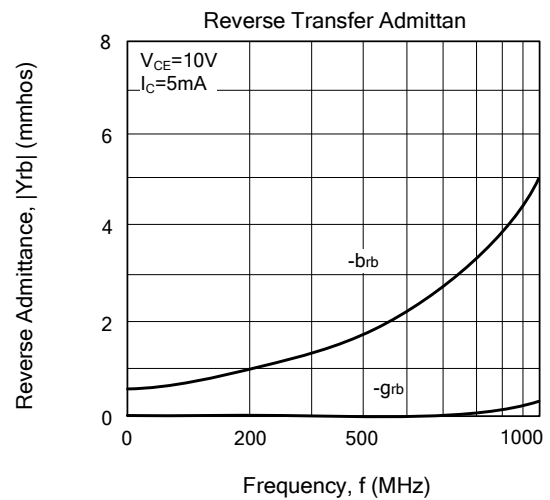
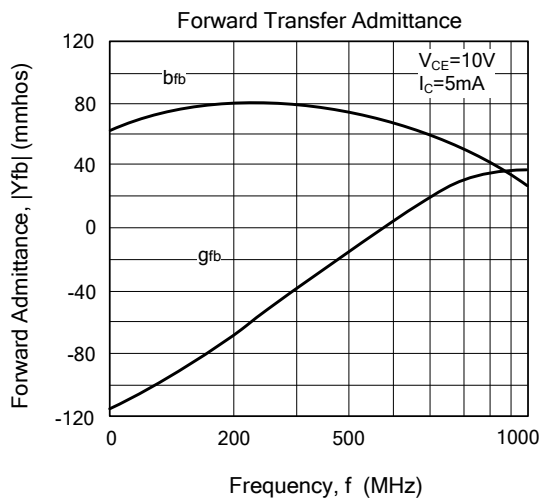
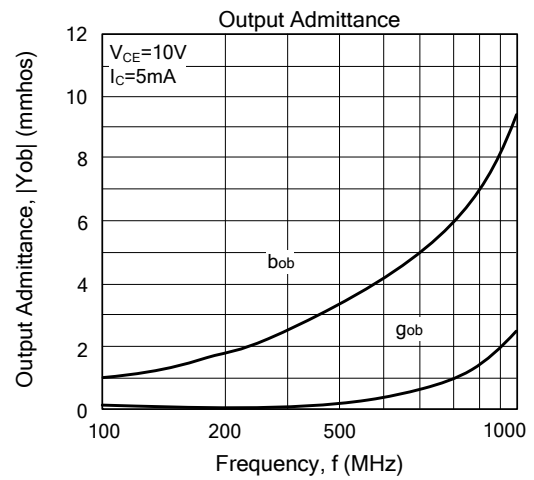
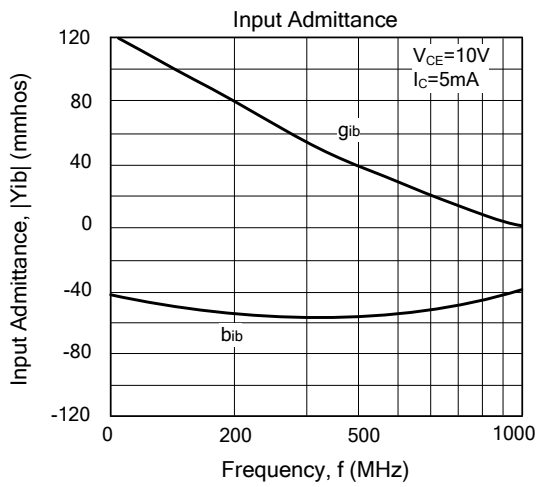

■ TYPICAL CHARACTERISTICS (Cont.)

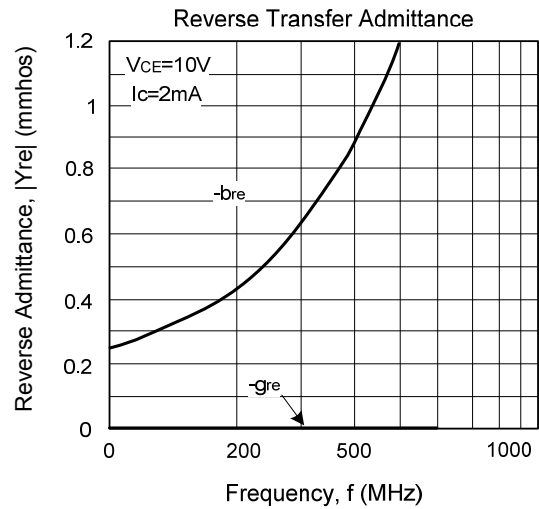
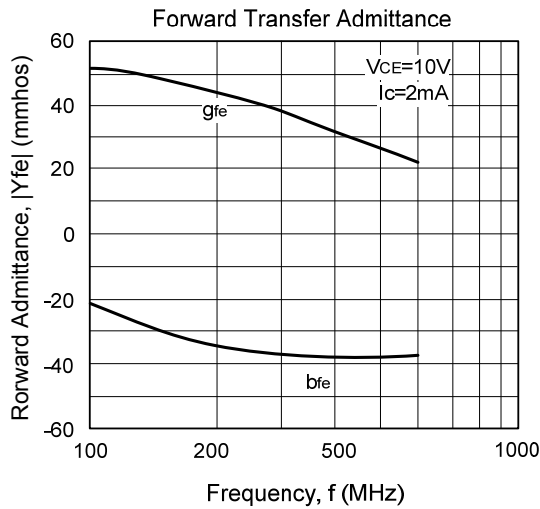

UTC assumes no responsibility for equipment failures that result from using products at values that exceed, even momentarily, rated values (such as maximum ratings, operating condition ranges, or other parameters) listed in products specifications of any and all UTC products described or contained herein. UTC products are not designed for use in life support appliances, devices or systems where malfunction of these products can be reasonably expected to result in personal injury. Reproduction in whole or in part is prohibited without the prior written consent of the copyright owner. UTC reserves the right to make changes to information published in this document, including without limitation specifications and product descriptions, at any time and without notice. This document supersedes and replaces all information supplied prior to the publication hereof.