

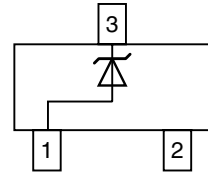

Small Signal Zener Diodes

Features

- Silicon planar Zener diodes.
- Standard Zener voltage tolerance is $\pm 5\%$. Other tolerances are available upon request.
- These diodes are also available in DO35 case with the type designation 1N4681...1N4717 and SOD123 case with the type designation MMSZ4681-V...MMSZ4717-V
- Lead (Pb)-free component
- Component in accordance to RoHS 2002/95/EC and WEEE 2002/96/EC

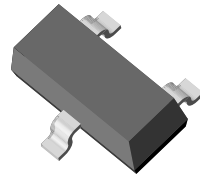

18078

Mechanical Data

Case: SOT23 plastic case

Weight: approx. 8.8 mg

Terminals: solderable per MIL-STD-750, method 2026

Packaging codes/options:

GS18/10 k per 13" reel (8 mm tape), 10 k/box

GS08/3 k per 7" reel (8 mm tape), 15 k/box

Absolute Maximum Ratings

$T_{amb} = 25\text{ }^\circ\text{C}$, unless otherwise specified

Parameter	Test conditions	Symbol	Value	Unit
Zener current (see table "Characteristics")				
Power dissipation	$T_A = 25\text{ }^\circ\text{C}$	P_{tot}	350 ¹⁾	mW

Note

¹⁾ On FR - 5 board using recommended solder pad layout.

Thermal Characteristics

$T_{amb} = 25\text{ }^\circ\text{C}$, unless otherwise specified

Parameter	Test conditions	Symbol	Value	Unit
Thermal resistance junction to ambient air		R_{thJA}	420 ¹⁾	K/W
Maximum junction temperature		T_j	150	$^\circ\text{C}$
Storage temperature range		T_{stg}	- 55 to + 150	$^\circ\text{C}$

Note

¹⁾ On FR - 5 board using recommended solder pad layout.

MMBZ4681-V to MMBZ4717-V



Vishay Semiconductors

Electrical Characteristics

Maximum $V_F = 0.9$ V, at $I_F = 10$ mA

Partnumber	Marking code	Zener voltage ¹⁾			Max. reverse current	Reverse voltage	Max. voltage change
		V_Z at $I_{ZT} = 50$ μ A					
		typ.	min.	max.	I_R μ A	V_R V	ΔV_Z ²⁾ V
MMBZ4681-V	CF	2.4	2.28	2.52	2.0	1.0	0.80
MMBZ4682-V	CH	2.7	2.57	2.84	1.0	1.0	0.85
MMBZ4683-V	CJ	3.0	2.85	3.15	0.8	1.0	0.90
MMBZ4684-V	CK	3.3	3.14	3.47	7.5	1.5	0.95
MMBZ4685-V	CM	3.6	3.42	3.78	7.5	2.0	0.95
MMBZ4686-V	CN	3.9	3.71	4.10	5.0	2.0	0.97
MMBZ4687-V	CP	4.3	4.09	4.52	4.0	2.0	0.99
MMBZ4688-V	CT	4.7	4.47	4.94	10.0	3.0	0.99
MMBZ4689-V	CU	5.1	4.85	5.36	10.0	3.0	0.97
MMBZ4690-V	CV	5.6	5.32	5.88	10.0	4.0	0.96
MMBZ4691-V	CA	6.2	5.89	6.51	10.0	5.0	0.95
MMBZ4692-V	CX	6.8	6.46	7.14	10.0	5.1	0.90
MMBZ4693-V	CY	7.5	7.13	7.88	10.0	5.7	0.75
MMBZ4694-V	CZ	8.2	7.79	8.61	1.0	6.2	0.5
MMBZ4695-V	DC	8.7	8.27	9.14	1.0	6.6	0.1
MMBZ4696-V	DD	9.1	8.65	9.56	1.0	6.9	0.08
MMBZ4697-V	DE	10.0	9.50	10.5	1.0	7.6	0.1
MMBZ4698-V	DF	11.0	10.50	11.6	0.05	8.4	0.11
MMBZ4699-V	DH	12.0	11.40	12.6	0.05	9.1	0.12
MMBZ4700-V	DJ	13.0	12.40	13.7	0.05	9.8	0.13
MMBZ4701-V	DK	14.0	13.30	14.7	0.05	10.6	0.14
MMBZ4702-V	DM	15.0	14.30	15.8	0.05	11.4	0.15
MMBZ4703-V	DN	16.0	15.20	16.8	0.05	12.1	0.16
MMBZ4704-V	DP	17.0	16.20	17.9	0.05	12.9	0.17
MMBZ4705-V	DT	18.0	17.10	18.9	0.05	13.6	0.18
MMBZ4706-V	DU	19.0	18.10	20.0	0.05	14.4	0.19
MMBZ4707-V	DV	20.0	19.00	21.0	0.01	15.2	0.2
MMBZ4708-V	DA	22.0	20.90	23.1	0.01	16.7	0.22
MMBZ4709-V	DZ	24.0	22.80	25.2	0.01	18.2	0.24
MMBZ4710-V	DY	25.0	23.80	26.3	0.01	19.0	0.25
MMBZ4711-V	EA	27.0	25.70	28.4	0.01	20.4	0.27
MMBZ4712-V	EC	28.0	26.60	29.4	0.01	21.2	0.28
MMBZ4713-V	ED	30.0	28.50	31.5	0.01	22.8	0.3
MMBZ4714-V	EE	33.0	31.40	34.7	0.01	25.0	0.33
MMBZ4715-V	EF	36.0	34.20	37.8	0.01	27.3	0.36
MMBZ4716-V	EH	39.0	37.10	41.0	0.01	29.6	0.39
MMBZ4717-V	EJ	43.0	40.90	45.2	0.01	32.6	0.43

Notes

¹⁾ Tested with pulse test current

²⁾ Maximum voltage change (V_Z). Voltage change is equal to the difference between V_Z at 100 μ A and V_Z at 10 μ A.

Typical Characteristics

$T_{amb} = 25\text{ }^{\circ}\text{C}$, unless otherwise specified

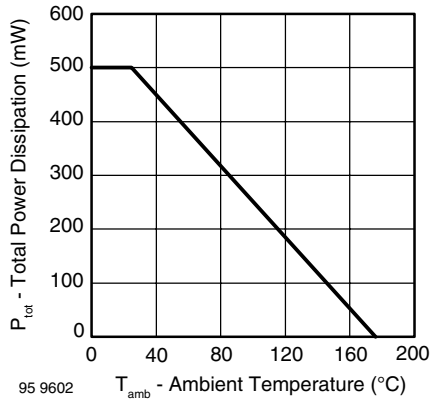

Figure 1. Total Power Dissipation vs. Ambient Temperature

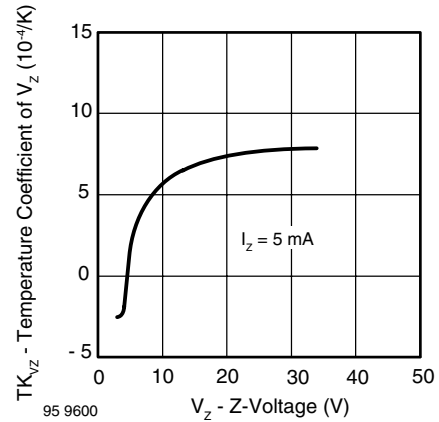

Figure 4. Temperature Coefficient of V_z vs. Z-Voltage

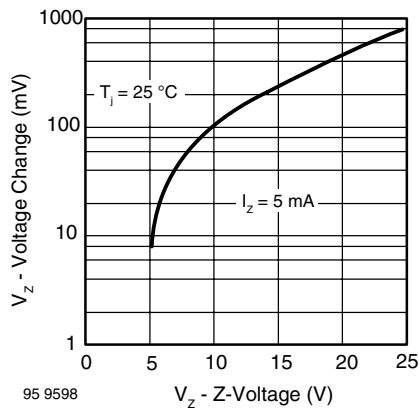

Figure 2. Typical Change of Working Voltage under Operating Conditions at $T_{amb} = 25\text{ }^{\circ}\text{C}$

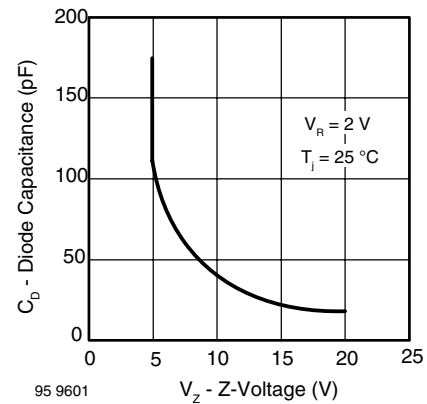

Figure 5. Diode Capacitance vs. Z-Voltage

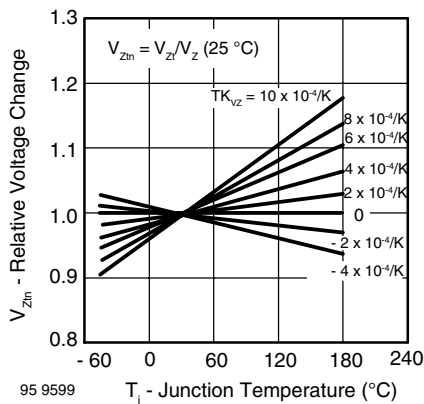

Figure 3. Typical Change of Working Voltage vs. Junction Temperature

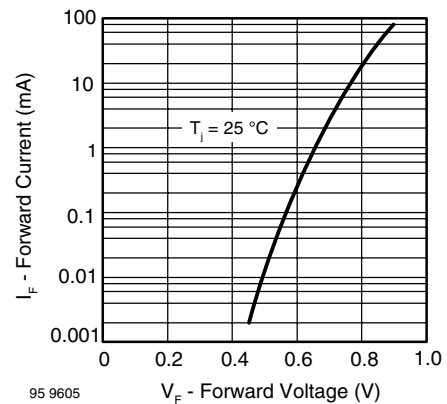

Figure 6. Forward Current vs. Forward Voltage

MMBZ4681-V to MMBZ4717-V



Vishay Semiconductors

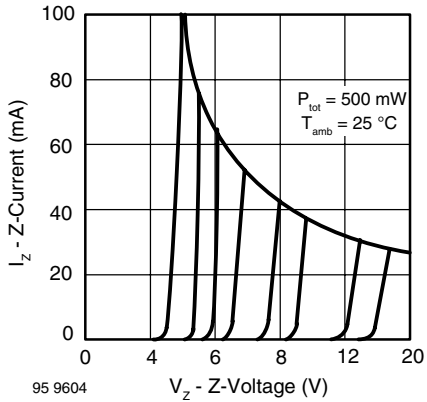

Figure 7. Z-Current vs. Z-Voltage

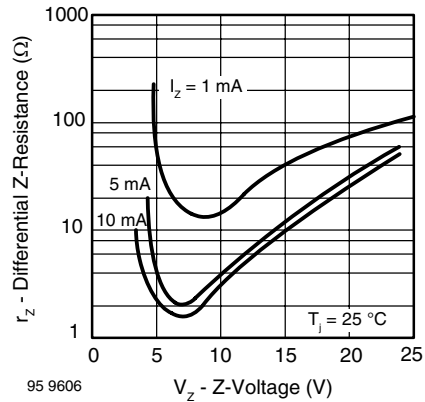

Figure 9. Differential Z-Resistance vs. Z-Voltage

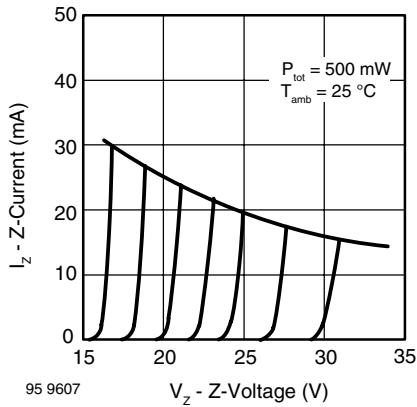

Figure 8. Z-Current vs. Z-Voltage

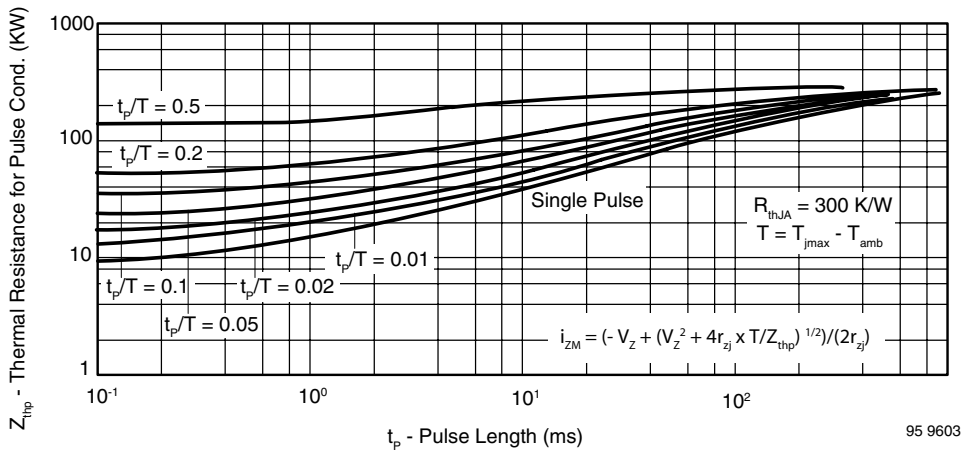

Figure 10. Thermal Response



MMBZ4681-V to MMBZ4717-V

Vishay Semiconductors

Package Dimensions in millimeters (inches): SOT23

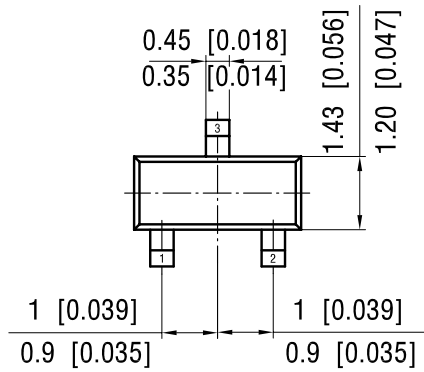
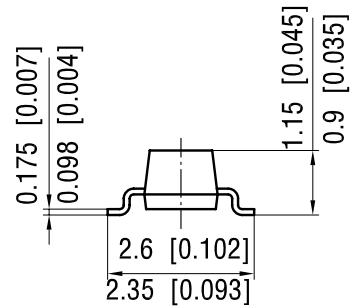
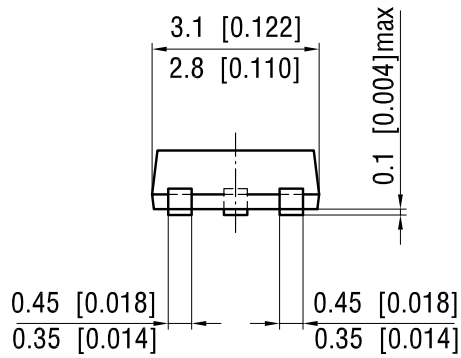

foot print recommendation:

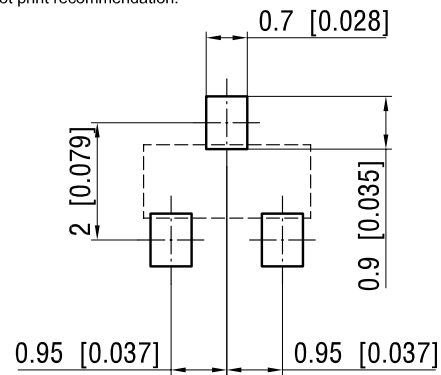

Document no.: 6.541-5014.01-4
Rev. 7 - Date: 08.July.2004

17418



Ozone Depleting Substances Policy Statement

It is the policy of Vishay Semiconductor GmbH to

1. Meet all present and future national and international statutory requirements.
2. Regularly and continuously improve the performance of our products, processes, distribution and operating systems with respect to their impact on the health and safety of our employees and the public, as well as their impact on the environment.

It is particular concern to control or eliminate releases of those substances into the atmosphere which are known as ozone depleting substances (ODSs).

The Montreal Protocol (1987) and its London Amendments (1990) intend to severely restrict the use of ODSs and forbid their use within the next ten years. Various national and international initiatives are pressing for an earlier ban on these substances.

Vishay Semiconductor GmbH has been able to use its policy of continuous improvements to eliminate the use of ODSs listed in the following documents.

1. Annex A, B and list of transitional substances of the Montreal Protocol and the London Amendments respectively.
2. Class I and II ozone depleting substances in the Clean Air Act Amendments of 1990 by the Environmental Protection Agency (EPA) in the USA.
3. Council Decision 88/540/EEC and 91/690/EEC Annex A, B and C (transitional substances) respectively.

Vishay Semiconductor GmbH can certify that our semiconductors are not manufactured with ozone depleting substances and do not contain such substances.

We reserve the right to make changes to improve technical design
and may do so without further notice.

Parameters can vary in different applications. All operating parameters must be validated for each customer application by the customer. Should the buyer use Vishay Semiconductors products for any unintended or unauthorized application, the buyer shall indemnify Vishay Semiconductors against all claims, costs, damages, and expenses, arising out of, directly or indirectly, any claim of personal damage, injury or death associated with such unintended or unauthorized use.

Vishay Semiconductor GmbH, P.O.B. 3535, D-74025 Heilbronn, Germany



Disclaimer

All product specifications and data are subject to change without notice.

Vishay Intertechnology, Inc., its affiliates, agents, and employees, and all persons acting on its or their behalf (collectively, "Vishay"), disclaim any and all liability for any errors, inaccuracies or incompleteness contained herein or in any other disclosure relating to any product.

Vishay disclaims any and all liability arising out of the use or application of any product described herein or of any information provided herein to the maximum extent permitted by law. The product specifications do not expand or otherwise modify Vishay's terms and conditions of purchase, including but not limited to the warranty expressed therein, which apply to these products.

No license, express or implied, by estoppel or otherwise, to any intellectual property rights is granted by this document or by any conduct of Vishay.

The products shown herein are not designed for use in medical, life-saving, or life-sustaining applications unless otherwise expressly indicated. Customers using or selling Vishay products not expressly indicated for use in such applications do so entirely at their own risk and agree to fully indemnify Vishay for any damages arising or resulting from such use or sale. Please contact authorized Vishay personnel to obtain written terms and conditions regarding products designed for such applications.

Product names and markings noted herein may be trademarks of their respective owners.