



SOT-363 Plastic-Encapsulate Transistors

MMDT2907A DUAL TRANSISTOR (PNP+PNP)

FEATURE

- Complementary NPN Type available MMDT2222A

MARKING: K2F

MAXIMUM RATINGS (T_a=25°C unless otherwise noted)

Symbol	Parameter	Value	Units
V _{CBO}	Collector-Base Voltage	-60	V
V _{CEO}	Collector-Emitter Voltage	-60	V
V _{EBO}	Emitter-Base Voltage	-5	V
I _C	Collector Current -Continuous	-600	mA
P _C	Collector Power Dissipation	200	mW
T _J	Junction Temperature	150	°C
T _{stg}	Storage Temperature	-55-150	°C

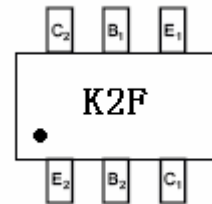
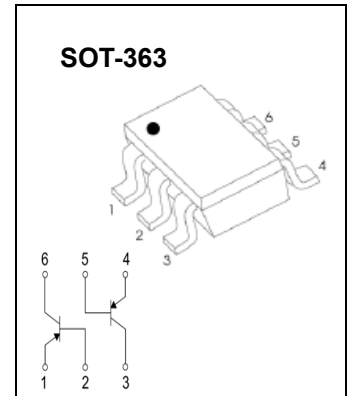

ELECTRICAL CHARACTERISTICS (T_a=25°C unless otherwise specified)

Parameter	Symbol	Test conditions	Min	Max	Unit
Collector-base breakdown voltage	V _{(BR)CBO}	I _C = -10μA, I _E =0	-60		V
Collector-emitter breakdown voltage	V _{(BR)CEO}	I _C = -10mA, I _B =0	-60		V
Emitter-base breakdown voltage	V _{(BR)EBO}	I _E =-10μA, I _C =0	-5		V
Collector cut-off current	I _{CBO}	V _{CB} =-50V, I _E =0		-10	nA
Collector cut-off current	I _{CEX}	V _{CE} =-30V, V _{EB(off)} =-0.5V		-50	nA
Emitter cut-off current	I _{EBO}	V _{EB} =-5V, I _C =0		-10	nA
DC current gain	h _{FE(1)}	V _{CE} =-10V, I _C = -0.1mA	75		
	h _{FE(2)}	V _{CE} =-10V, I _C = -1mA	100		
	h _{FE(3)}	V _{CE} =-10V, I _C =-10mA	100		
	h _{FE(4)}	V _{CE} =-10V, I _C = -150mA	100	300	
	h _{FE(5)}	V _{CE} =-10V, I _C =-500mA	50		
Collector-emitter saturation voltage	V _{CE(sat)1}	I _C =-150mA, I _B =-15mA		-0.4	V
	V _{CE(sat)2}	I _C =-500mA, I _B =- 50mA		-1.6	V
Base-emitter saturation voltage	V _{BE(sat)1}	I _C =-150mA, I _B =-15mA		-1.3	V
	V _{BE(sat)2}	I _C =-500mA, I _B = -50mA		-2.6	V
Transition frequency	f _T	V _{CE} =-20V, I _C = -50mA, f=100MHz	200		MHz
Output Capacitance	C _{ob}	V _{CB} =-10V, I _E = 0, f=1MHz		8	pF
Input Capacitance	C _{ib}	V _{EB} =-2V, I _C = 0, f=1MHz		30	pF
Delay time	t _d	V _{CC} =-30V, I _C =-150mA, I _{B1} =-15mA		10	ns
Rise time	t _r			40	ns
Storage time	t _s	V _{CC} =-6V, I _C =-150mA, I _{B1} = I _{B2} = -15mA		225	ns
Fall time	t _f			60	ns

Typical Characteristics

Static Characteristic

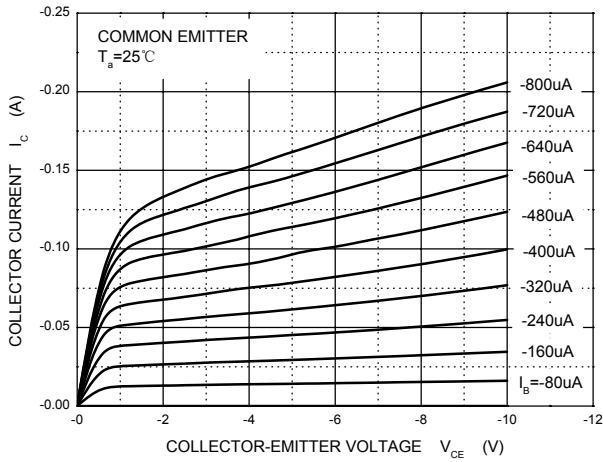

h_{FE} — I_C

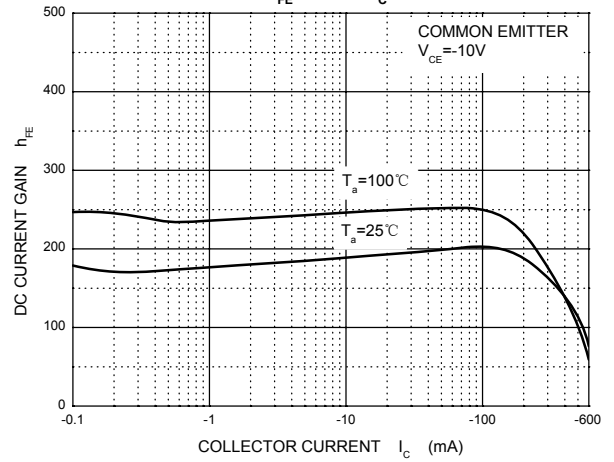

V_{CEsat} — I_C

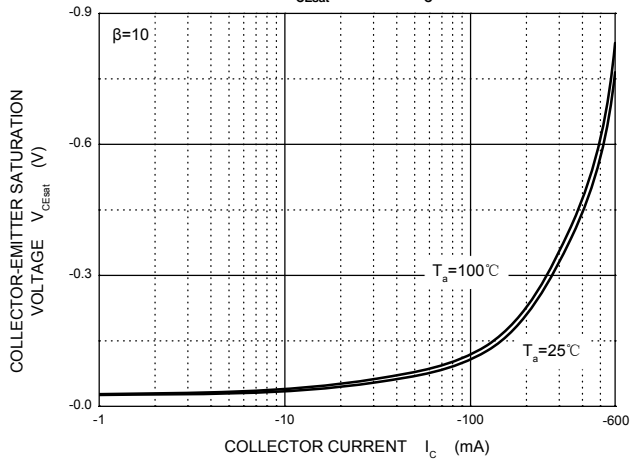

V_{BEsat} — I_C

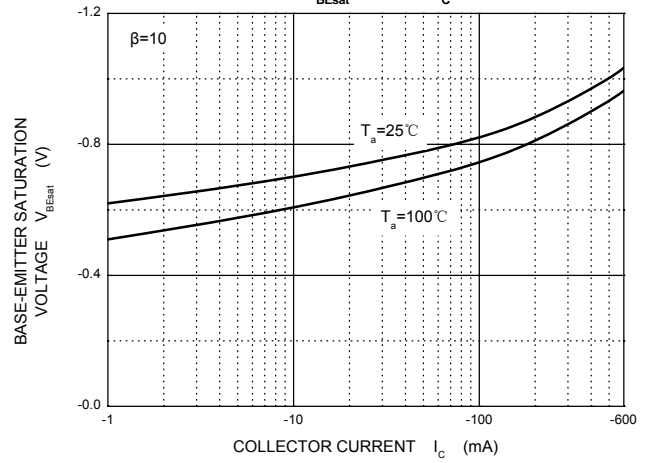

I_C — V_{BE}

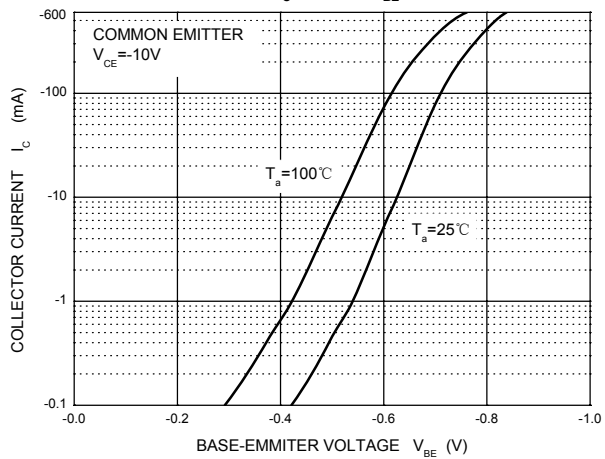

C_{ob}/C_{ib} — V_{CB}/V_{EB}

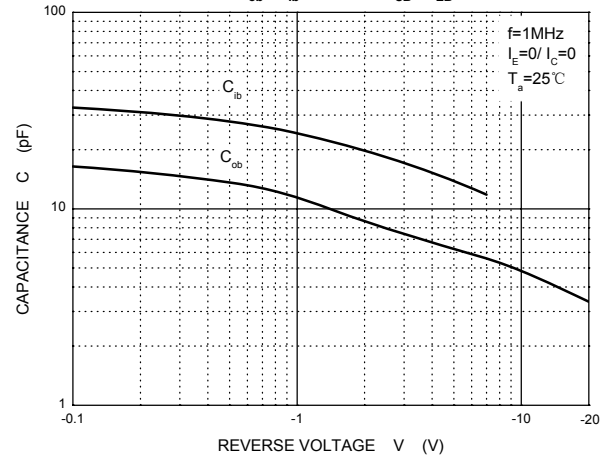

P_c — T_a

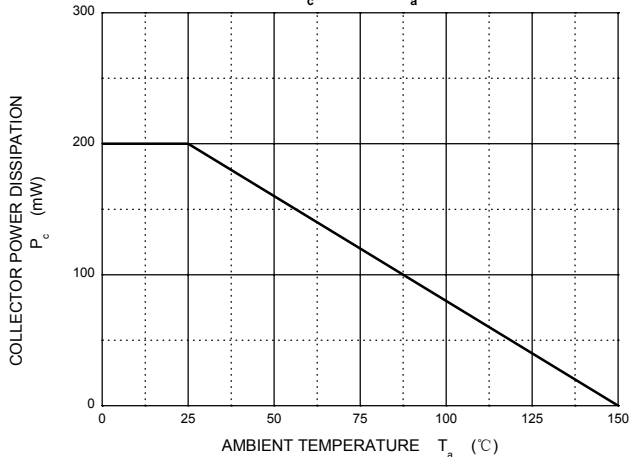

SOT-363 Package Outline Dimensions

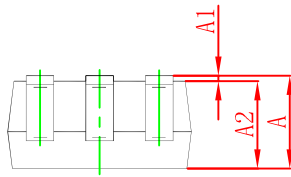
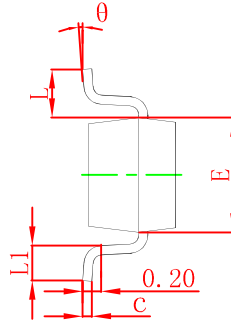
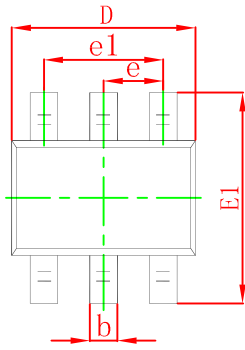

Symbol	Dimensions In Millimeters		Dimensions In Inches	
	Min	Max	Min	Max
A	0.900	1.100	0.035	0.043
A1	0.000	0.100	0.000	0.004
A2	0.900	1.000	0.035	0.039
b	0.150	0.350	0.006	0.014
c	0.100	0.150	0.004	0.006
D	2.000	2.200	0.079	0.087
E	1.150	1.350	0.045	0.053
E1	2.150	2.400	0.085	0.094
e	0.650 TYP		0.026 TYP	
e1	1.200	1.400	0.047	0.055
L	0.525 REF		0.021 REF	
L1	0.260	0.460	0.010	0.018
theta	0°	8°	0°	8°

SOT-363 Suggested Pad Layout

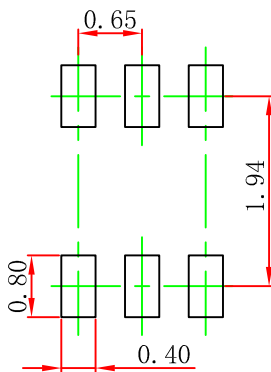

Note:

1. Controlling dimension: in millimeters.
2. General tolerance: $\pm 0.05\text{mm}$.
3. The pad layout is for reference purposes only.

NOTICE

JCET reserve the right to make modifications, enhancements, improvements, corrections or other changes without further notice to any product herein. JCET does not assume any liability arising out of the application or use of any product described herein.

SOT-363 Embossed Carrier Tape

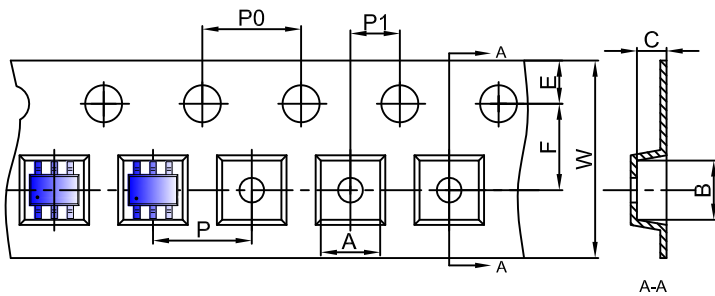

Packaging Description:

SOT-363 parts are shipped in tape. The carrier tape is made from a dissipative (carbon filled) polycarbonate resin. The cover tape is a multilayer film (Heat Activated Adhesive in nature) primarily composed of polyester film, adhesive layer, sealant, and anti-static sprayed agent. These reeled parts in standard option are shipped with 3,000 units per 7" or 17.8cm diameter reel. The reels are clear in color and is made of polystyrene plastic (anti-static coated).

Dimensions are in millimeter										
Pkg type	A	B	C	d	E	F	P0	P	P1	W
SOT-363	2.25	2.55	1.20	Ø1.50	1.75	3.50	4.00	4.00	2.00	8.00

SOT-363 Tape Leader and Trailer

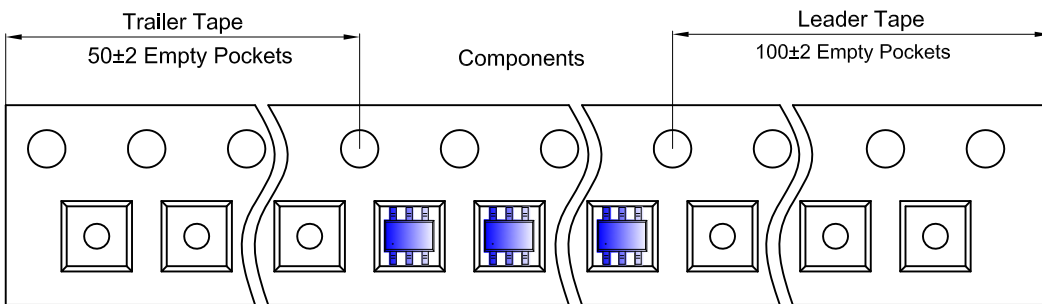

SOT-363 Reel

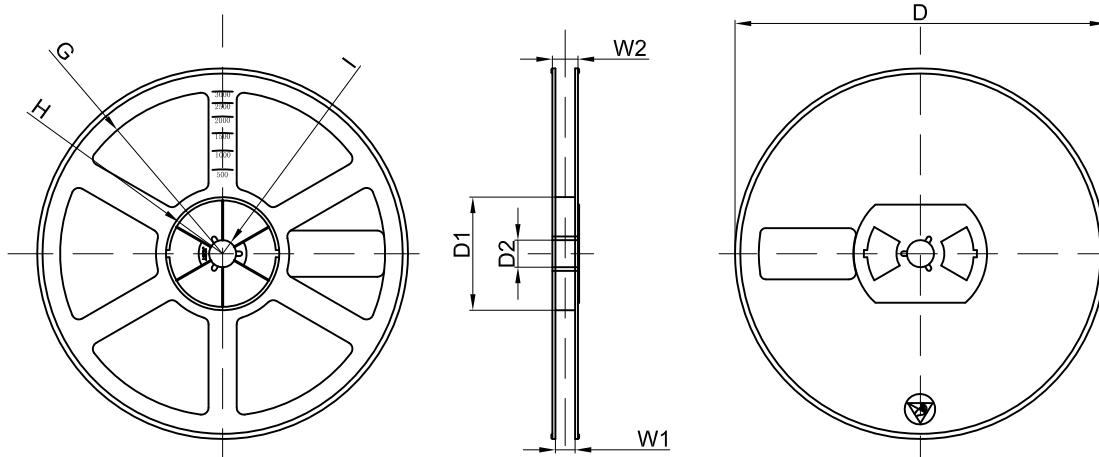

Dimensions are in millimeter								
Reel Option	D	D1	D2	G	H	I	W1	W2
7"Dia	Ø178.00	54.40	13.00	R78.00	R25.60	R6.50	9.50	12.30

REEL	Reel Size	Box	Box Size(mm)	Carton	Carton Size(mm)	G.W.(kg)
3000 pcs	7 inch	45,000 pcs	203×203×195	180,000 pcs	438×438×220	