

MMIS70R1K4P

700V 1.4Ω N-channel MOSFET

■ Description

MMIS70R1K4P is power MOSFET using magnachip's advanced super junction technology that can realize very low on-resistance and gate charge. It will provide much high efficiency by using optimized charge coupling technology. These user friendly devices give an advantage of Low EMI to designers as well as low switching loss.

■ Key Parameters

Parameter	Value	Unit
$V_{DS} @ T_{j,max}$	750	V
$R_{DS(on),max}$	1.4	Ω
$V_{TH,typ}$	3	V
I_D	3.2	A
$Q_{g,typ}$	11	nC

■ Package & Internal Circuit

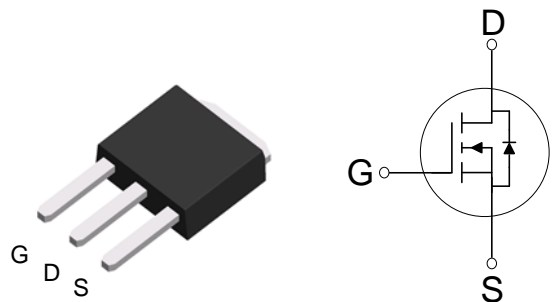

■ Features

- Low Power Loss by High Speed Switching and Low On-Resistance
- 100% Avalanche Tested
- Green Package – Pb Free Plating, Halogen Free

■ Applications

- PFC Power Supply Stages
- Switching Applications
- Adapter
- Motor Control
- DC – DC Converters

■ Ordering Information

Order Code	Marking	Temp. Range	Package	Packing	RoHS Status
MMIS70R1K4PTH	70R1K4P	-55 ~ 150°C	TO-251-VS	Tube	Halogen Free

■ Absolute Maximum Rating ($T_c=25^\circ\text{C}$ unless otherwise specified)

Parameter	Symbol	Rating	Unit	Note
Drain – Source voltage	V_{DSS}	700	V	
Gate – Source voltage	V_{GSS}	± 30	V	
Continuous drain current	I_D	3.2	A	$T_c=25^\circ\text{C}$
		2	A	$T_c=100^\circ\text{C}$
Pulsed drain current ⁽¹⁾	I_{DM}	9.6	A	
Power dissipation	P_D	33	W	
Single - pulse avalanche energy	E_{AS}	26	mJ	
MOSFET dv/dt ruggedness	dv/dt	50	V/ns	
Diode dv/dt ruggedness ⁽²⁾	dv/dt	15	V/ns	
Storage temperature	T_{stg}	-55 ~150	$^\circ\text{C}$	
Maximum operating junction temperature	T_j	150	$^\circ\text{C}$	

1) Pulse width t_p limited by $T_{j,max}$

2) $I_{SD} \leq I_D, V_{DS\ peak} \leq V_{(BR)DSS}$

■ Thermal Characteristics

Parameter	Symbol	Value	Unit
Thermal resistance, junction-case max	R_{thjc}	3.8	$^\circ\text{C/W}$
Thermal resistance, junction-ambient max	R_{thja}	62.5	$^\circ\text{C/W}$

■ Static Characteristics ($T_c=25^\circ\text{C}$ unless otherwise specified)

Parameter	Symbol	Min.	Typ.	Max.	Unit	Test Condition
Drain – Source Breakdown voltage	$V_{(BR)DSS}$	700	-	-	V	$V_{GS} = 0V, I_D=0.25mA$
Gate Threshold Voltage	$V_{GS(th)}$	2	3	4	V	$V_{DS} = V_{GS}, I_D=0.25mA$
Zero Gate Voltage Drain Current	I_{DSS}	-	-	1	μA	$V_{DS} = 700V, V_{GS} = 0V$
Gate Leakage Current	I_{GSS}	-	-	100	nA	$V_{GS} = \pm 30V, V_{DS} = 0V$
Drain-Source On State Resistance	$R_{DS(ON)}$	-	1.26	1.4	Ω	$V_{GS} = 10V, I_D = 1.0A$

■ Dynamic Characteristics ($T_c=25^\circ\text{C}$ unless otherwise specified)

Parameter	Symbol	Min.	Typ.	Max.	Unit	Test Condition
Input Capacitance	C_{iss}	-	312	-	pF	$V_{DS} = 25V, V_{GS} = 0V, f = 1.0MHz$
Output Capacitance	C_{oss}	-	240	-		
Reverse Transfer Capacitance	C_{rss}	-	15.4	-		
Effective Output Capacitance Energy Related ⁽³⁾	$C_{o(er)}$	-	13.5	-		
Turn On Delay Time	$t_{d(on)}$	-	9	-	ns	$V_{GS} = 10V, R_G = 25\Omega, V_{DS} = 350V, I_D = 3.2A$
Rise Time	t_r	-	20	-		
Turn Off Delay Time	$t_{d(off)}$	-	33	-		
Fall Time	t_f	-	21	-		
Total Gate Charge	Q_g	-	11	-	nC	$V_{GS} = 10V, V_{DS} = 560V, I_D = 3.2A$
Gate – Source Charge	Q_{gs}	-	2.2	-		
Gate – Drain Charge	Q_{gd}	-	5.1	-		
Gate Resistance	R_G	-	7.6	-	Ω	$V_{GS} = 0V, f = 1.0MHz$

3) $C_{o(er)}$ is a capacitance that gives the same stored energy as C_{oss} while V_{DS} is rising from 0V to 80% $V_{(BR)DSS}$

■ Reverse Diode Characteristics ($T_c=25^\circ\text{C}$ unless otherwise specified)

Parameter	Symbol	Min.	Typ.	Max.	Unit	Test Condition
Continuous Diode Forward Current	I_{SD}	-	-	3.2	A	
Diode Forward Voltage	V_{SD}	-	-	1.4	V	$I_{SD} = 3.2\text{ A}$, $V_{GS} = 0\text{ V}$
Reverse Recovery Time	t_{rr}	-	240	-	ns	$I_{SD} = 3.2\text{ A}$ $di/dt = 100\text{ A}/\mu\text{s}$ $V_{DD} = 100\text{ V}$
Reverse Recovery Charge	Q_{rr}	-	1.2	-	μC	
Reverse Recovery Current	I_{rrm}	-	9.6	-	A	

■ Characteristic Graph

Fig.1 On-Region Characteristics.

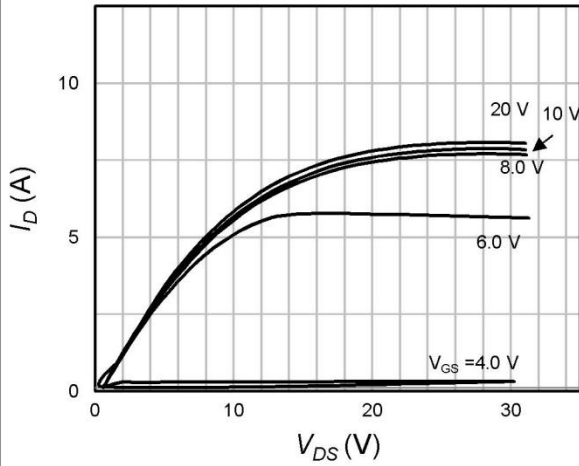

Fig.2 On-Resistance Variation with Drain Current and Gate Voltage

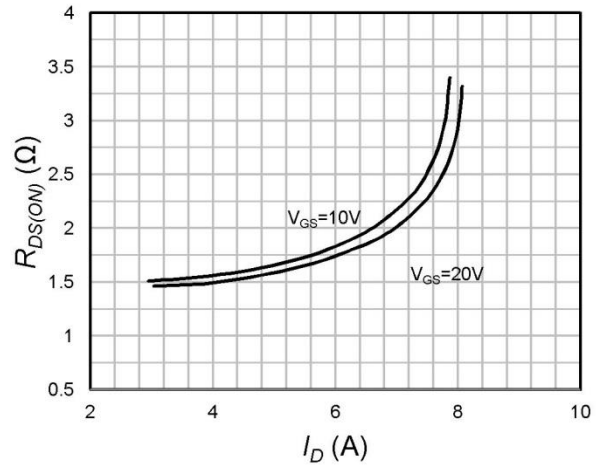

Fig.3 On-Resistance Variation with Temperature (Normalized)

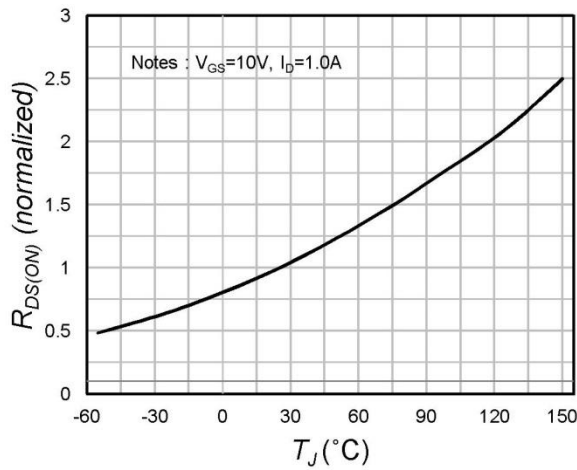

Fig.4 Breakdown Voltage Variation vs. Temperature (Normalized)

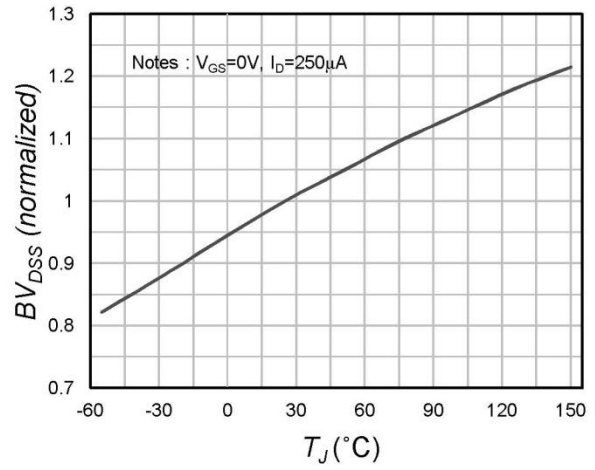

Fig.5 Transfer Characteristics

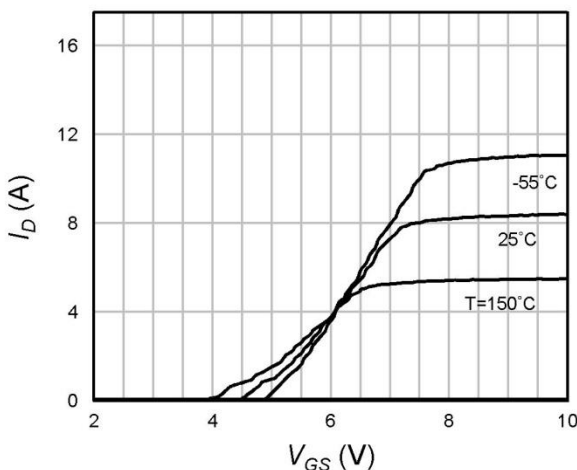

Fig.6 Body Diode Forward Voltage Variation with Source Current and Temperature

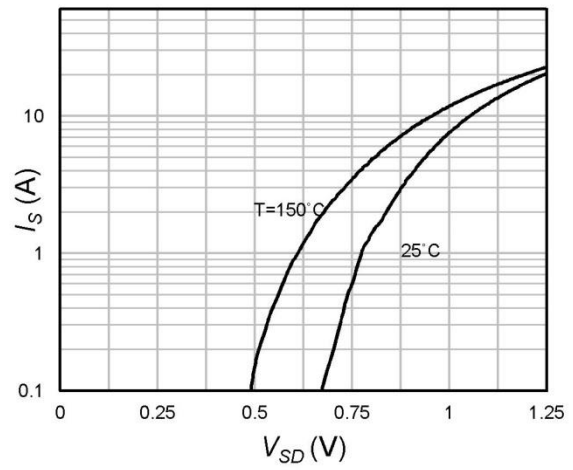

Fig.7 Gate Charge Characteristics

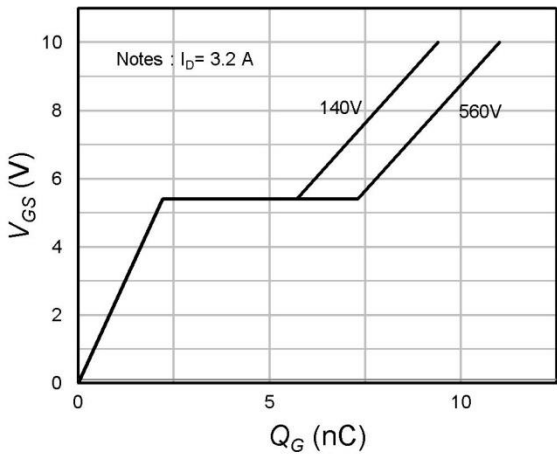

Fig.8 Capacitance Characteristics

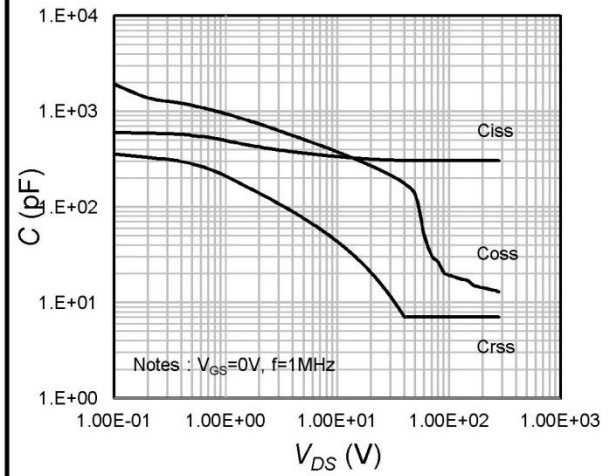

Fig.9 $V_{GS(th)}$ Variation with Temperature (Normalized)

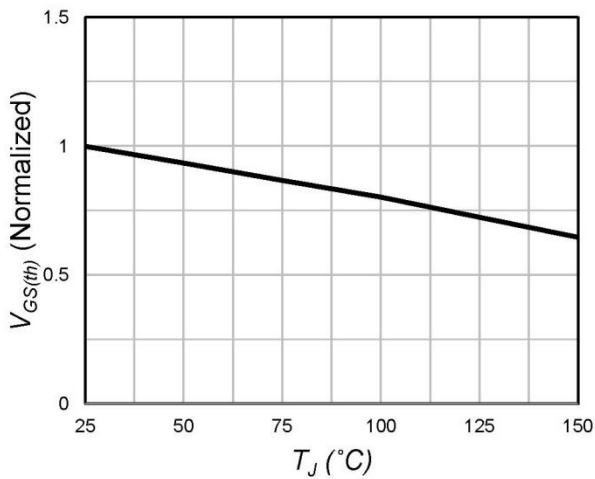

Fig.10 Maximum Drain Current vs. Case Temperature

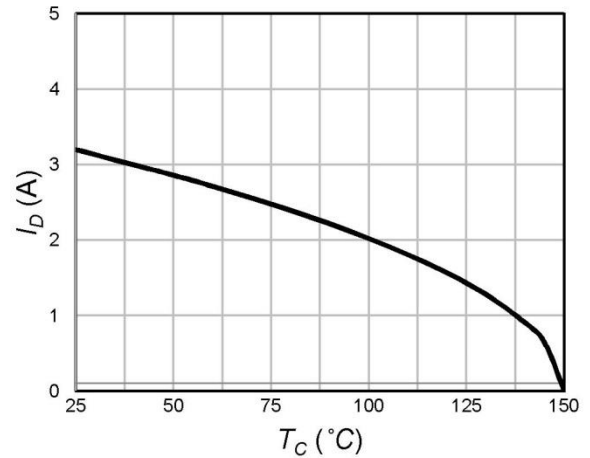

Fig.11 Single Pulse Maximum Power Dissipation

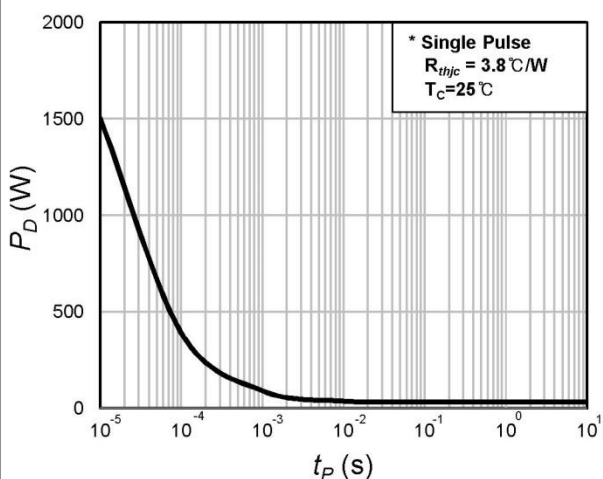

Fig.12 Output Capacitance Stored Energy

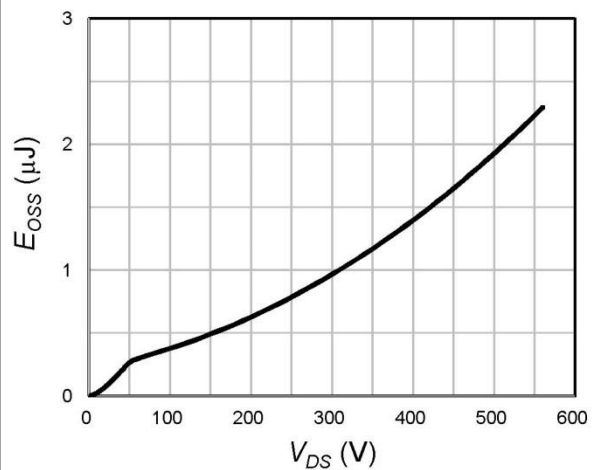

Fig.13 Transient Thermal Response Curve

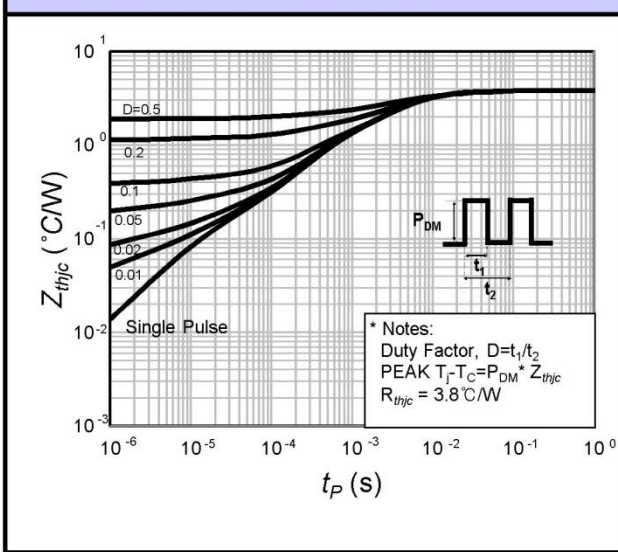
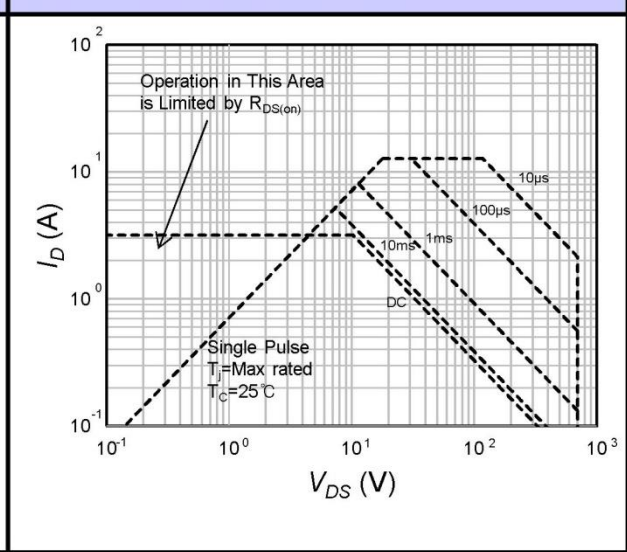
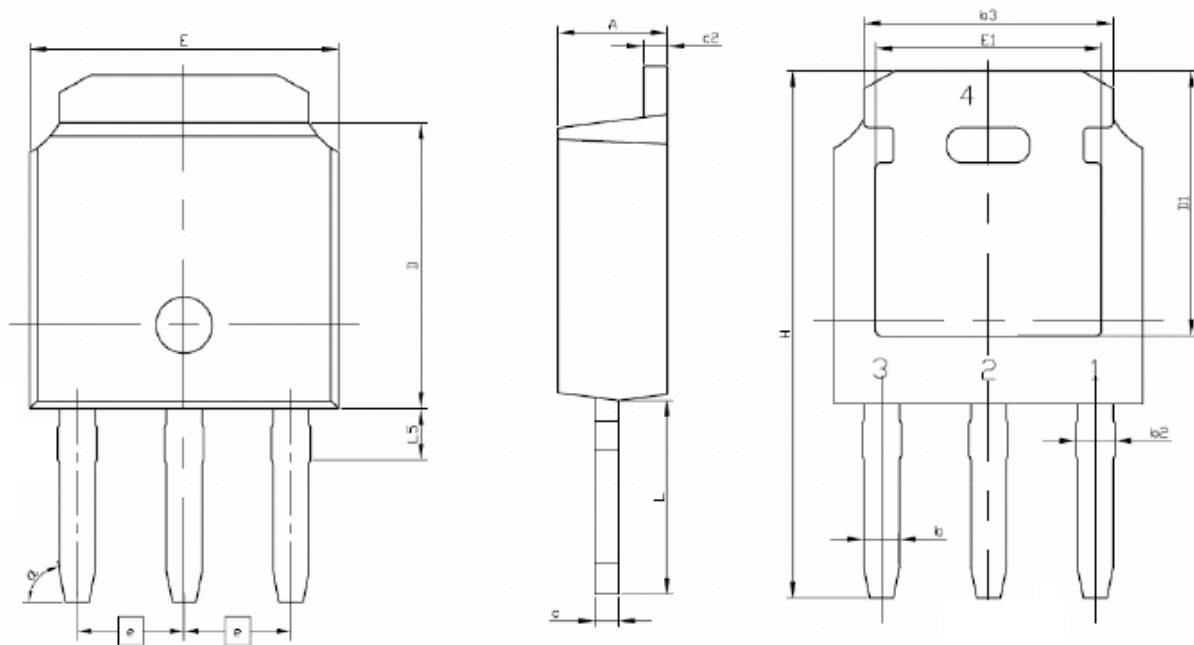

Fig.14 Maximum Safe Operating Area



Physical Dimension
TO251-3L (IPAK-VSL)

Dimensions are in millimeters, unless otherwise specified



Symbol	MILLIMETERS	
	Minimum	Maximum
A	2.18	2.39
b	0.64	0.89
b2	0.76	1.14
b3	4.95	5.46
c	0.40	0.61
c2	0.40	0.61
D	5.97	6.223
D1	5.10	-
e	2.286 BSC	
E	6.35	6.73
E1	4.32	-
H	10.26	11.45
L	3.98	4.28
L5	-	1.23

DISCLAIMER:

The Products are not designed for use in hostile environments, including, without limitation, aircraft, nuclear power generation, medical appliances, and devices or systems in which malfunction of any Product can reasonably be expected to result in a personal injury. Seller's customers using or selling Seller's products for use in such applications do so at their own risk and agree to fully defend and indemnify Seller.

MagnaChip reserves the right to change the specifications and circuitry without notice at any time. MagnaChip does not consider responsibility for use of any circuitry other than circuitry entirely included in a MagnaChip product.  is a registered trademark of MagnaChip Semiconductor Ltd.