

### PRODUCT FEATURES

- Electrically Isolated by DBC Ceramic
- High Surge Current Capability
- Low Inductance Package

### APPLICATIONS

- DC Motor Control and Drives
- Battery Charges ,Heater controls,Light dimmers
- Static switches

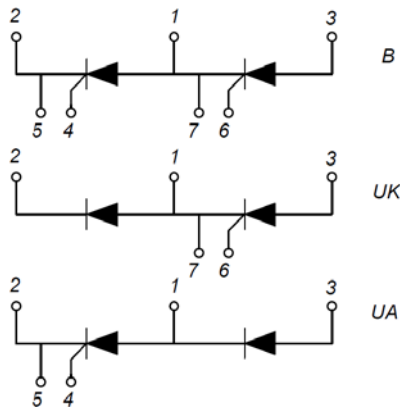

### MAXIMUM VOLTAGE RATINGS

$T_C = 25^\circ\text{C}$  unless otherwise specified

Module Type			$V_{RRM}/V_{DRM}$	$V_{RSM}$	Unit
MMK200S080B	MMK200S080UK	MMK200S080UA	800	900	V
MMK200S120B	MMK200S120UK	MMK200S120UA	1200	1300	
MMK200S140B	MMK200S140UK	MMK200S140UA	1400	1500	
MMK200S160B	MMK200S160UK	MMK200S160UA	1600	1700	
MMK200S180B	MMK200S180UK	MMK200S180UA	1800	1900	
MMK200S200B	MMK200S200UK	MMK200S200UA	2000	2100	
MMK200S220B	MMK200S220UK	MMK200S220UA	2200	2300	

### ABSOLUTE MAXIMUM RATINGS (Thyristor)

Symbol	Parameter/Test Conditions		Values	Unit
$I_{T(AV)}$	Average On State Current	Single phase, half wave, 180°conduction, $T_C = 80^\circ\text{C}$	200	A
$I_{T(RMS)}$	R.M.S. On State Current		310	
$I_{TSM}$	Non Repetitive Surge On State Current	1/2 cycle, 50/60Hz, peak value, $T_C = 45^\circ\text{C}$	5000/5400	
$I^2t$	$I^2t$ (For Fusing)	1/2 cycle, 50/60Hz, peak value, $T_C = 45^\circ\text{C}$	125/121	$\text{KA}^2\text{S}$
$T_J$	Junction Temperature(Thyristor)		-40 to +125	$^\circ\text{C}$

### ABSOLUTE MAXIMUM RATINGS (Diode)

Symbol	Parameter/Test Conditions		Values	Unit
$I_{F(AV)}$	Average Forward Current	Single phase, half wave, 180°conduction, $T_C = 95^\circ\text{C}$	200	A
$I_{F(RMS)}$	R.M.S. Forward Current		310	
$I_{FSM}$	Non Repetitive Surge Forward Current	1/2 cycle, 50/60Hz, peak value, $T_C = 45^\circ\text{C}$	6800/7300	
$I^2t$	For Fusing	1/2 cycle, 50/60Hz, peak value, $T_C = 45^\circ\text{C}$	231.2/221.1	$\text{KA}^2\text{S}$

## ELECTRICAL CHARACTERISTICS (Thyristor)

 $T_C=25^{\circ}\text{C}$  unless otherwise specified

Symbol	Parameter/Test Conditions		Min.	Typ.	Max.	Unit
$I_{\text{DRM}}$	Maximum Peak Off-State Current	$V_D = V_{\text{DRM}}, T_J = 125^{\circ}\text{C}$			25	mA
$I_{\text{RRM}}$	Maximum Peak Reverse Current	$V_R = V_{\text{RRM}}, T_J = 125^{\circ}\text{C}$			25	
$V_{\text{TM}}$	Maximum on state voltage drop	$I_{\text{TM}}=500\text{A}, t_d=10\text{ ms, half sine}$			1.75	V
$V_{\text{TO}}$	For power loss calculations only	$T_J = 125^{\circ}\text{C}$			0.80	V
$r_T$					2.0	m $\Omega$
$V_{\text{GT}}$	Max. required DC gate voltage to trigger	$V_A=6\text{V}, R_A=1\Omega, T_J = -40^{\circ}\text{C}$			4.0	V
		$V_A=6\text{V}, R_A=1\Omega$		1.0	2.5	
		$V_A=6\text{V}, R_A=1\Omega, T_J = 125^{\circ}\text{C}$			1.7	
$I_{\text{GT}}$	Max. required DC gate current to trigger	$V_A=6\text{V}, R_A=1\Omega, T_J = -40^{\circ}\text{C}$			270	mA
		$V_A=6\text{V}, R_A=1\Omega$		75	150	
		$V_A=6\text{V}, R_A=1\Omega, T_J = 125^{\circ}\text{C}$			80	
$V_{\text{GD}}$	Max. required DC gate voltage not to trigger,	$V_D = V_{\text{DRM}}, T_J = 125^{\circ}\text{C}$			0.25	V
$I_{\text{GD}}$	Max. required DC gate current not to trigger,	$V_D = V_{\text{DRM}}, T_J = 125^{\circ}\text{C}$			6	mA
$I_{\text{H}}$	Maximum holding current			100	200	mA
$I_{\text{L}}$	Maximum latching current			200	400	mA
$P_{\text{GM}}$	Maximum peak gate power				12	W
$P_{\text{G(AV)}}$	Maximum average gate power				3.0	
$I_{\text{GM}}$	Maximum peak gate current				3.0	A
$-V_{\text{GM}}$	Maximum peak negative gate voltage				10	V
$dv/dt$	Critical Rate of Rise of Off-State Voltage, $T_J=125^{\circ}\text{C}$ , exponential to 67% rated $V_{\text{DRM}}$				1000	V/ $\mu\text{s}$
$di/dt$	Max. Rate of Rise of Turned on Current, $T_J = 125^{\circ}\text{C}, I_{\text{TM}}=500\text{A}$ , rated $V_{\text{DRM}}$				150	A/ $\mu\text{s}$

## ELECTRICAL CHARACTERISTICS (Diode)

Symbol	Parameter/Test Conditions		Min.	Typ.	Max.	Unit
$I_{\text{RM}}$	Maximum Reverse Leakage Current	$V_R = V_{\text{RRM}}$			0.5	mA
		$V_R = V_{\text{RRM}}, T_J = 125^{\circ}\text{C}$			10	
$V_{\text{F}}$	Forward Voltage Drop	$I_{\text{F}}=500\text{A}$			1.5	V
$V_{\text{TO}}$	For power-loss calculations only, $T_J = 125^{\circ}\text{C}$				0.9	V
$r_T$					1.0	m $\Omega$

## MODULE CHARACTERISTICS

 $T_C=25^{\circ}\text{C}$  unless otherwise specified

$T_J$	Junction Temperature		-40 to +125	$^{\circ}\text{C}$
$T_{\text{STG}}$	Storage Temperature Range		-40 to +125	$^{\circ}\text{C}$
$V_{\text{ISO}}$	Isolation Breakdown Voltage	AC, 50Hz(R.M.S), $t=1\text{minute}$	3000	V
Torque	to heatsink	Recommended (M6)	3~5	Nm
Torque	to terminal	Recommended (M6)	3~5	Nm
$R_{\text{thJC}}$	Junction-to-Case Thermal Resistance(Per Thyristor/Per Diode)		0.12/0.14	K/W
Weight			160	g

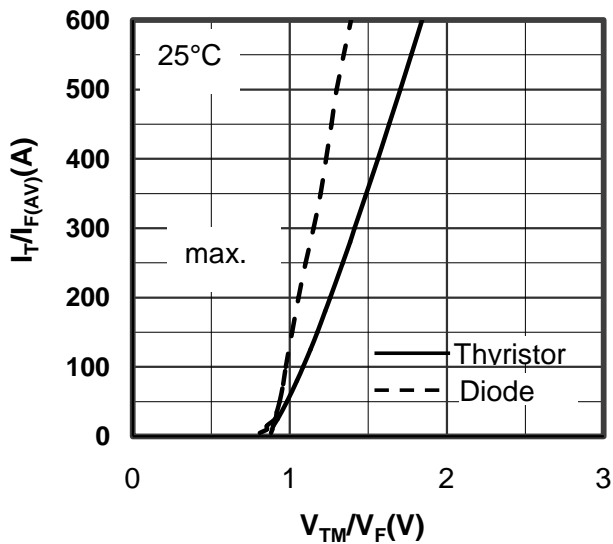

Figure 1. Forward Voltage Drop vs Forward Current

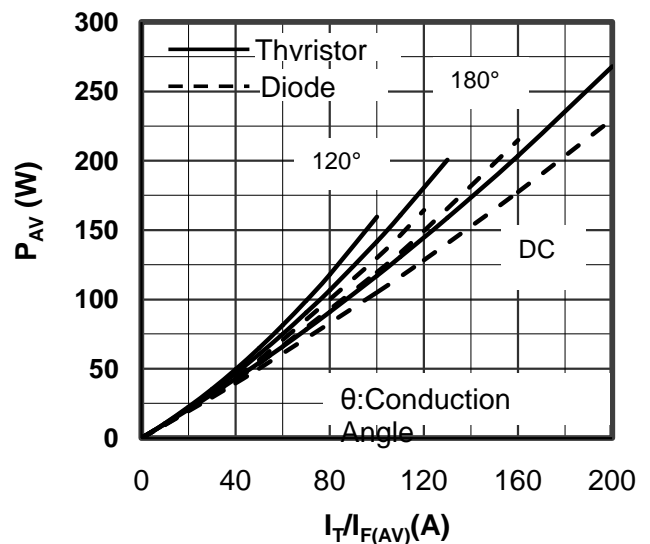

Figure 2. Power dissipation vs.  $I_T/I_{F(AV)}$

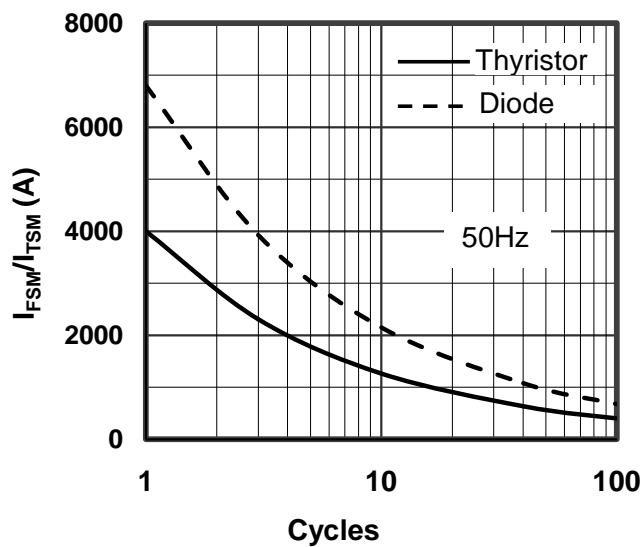

Figure 3. Diode and SCR Max Non-Repetitive Surge

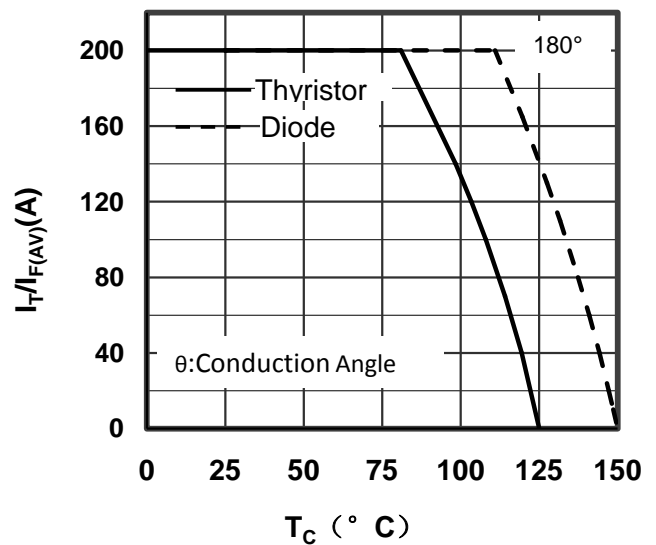

Figure 4. Diode  $I_{F(AV)}$  and SCR  $I_{T(AV)}$  vs.  $T_C$

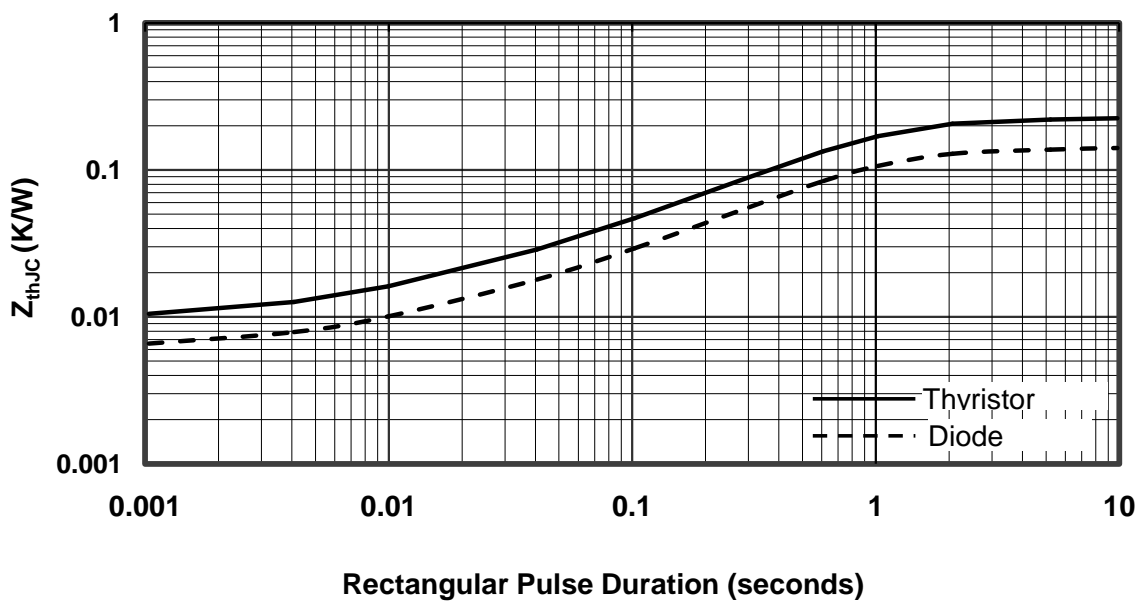

Figure 5. Transient Thermal Impedance of Diode and SCR

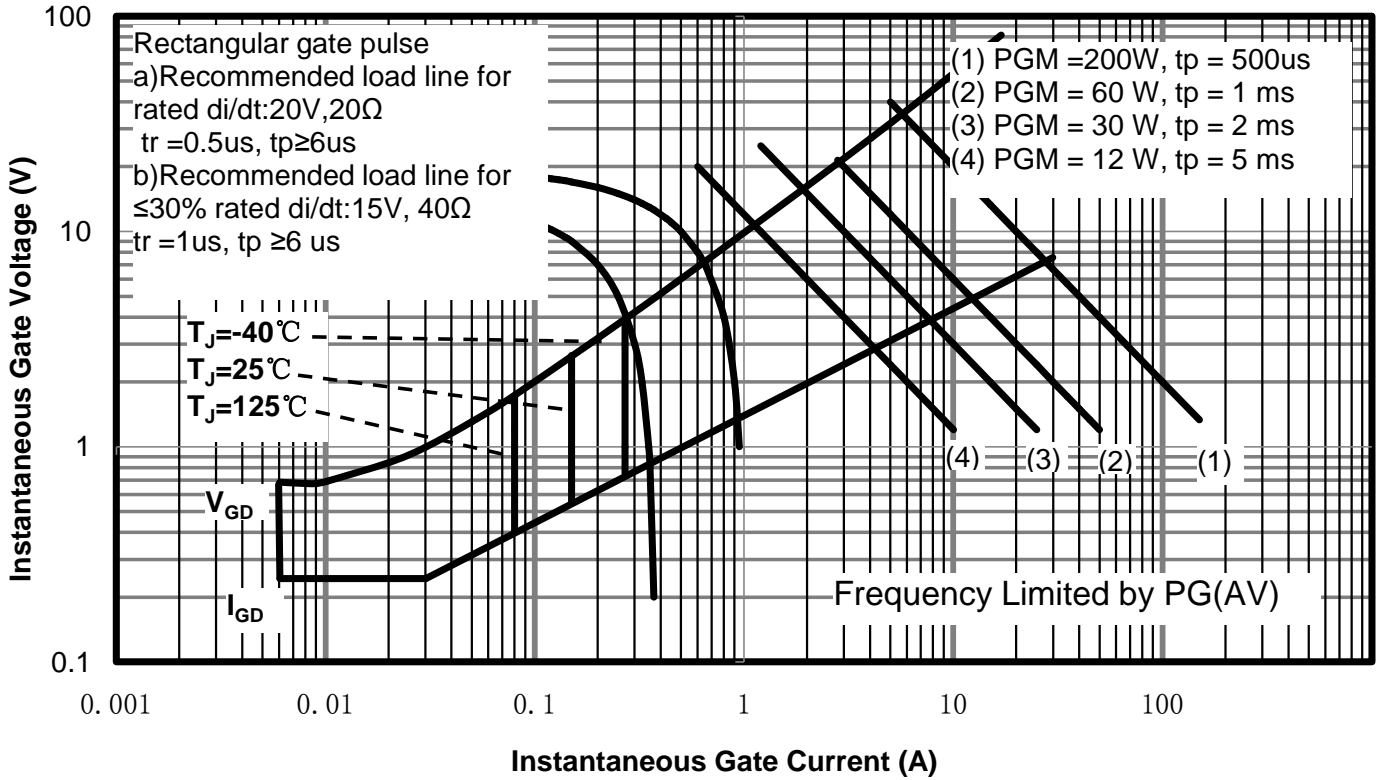
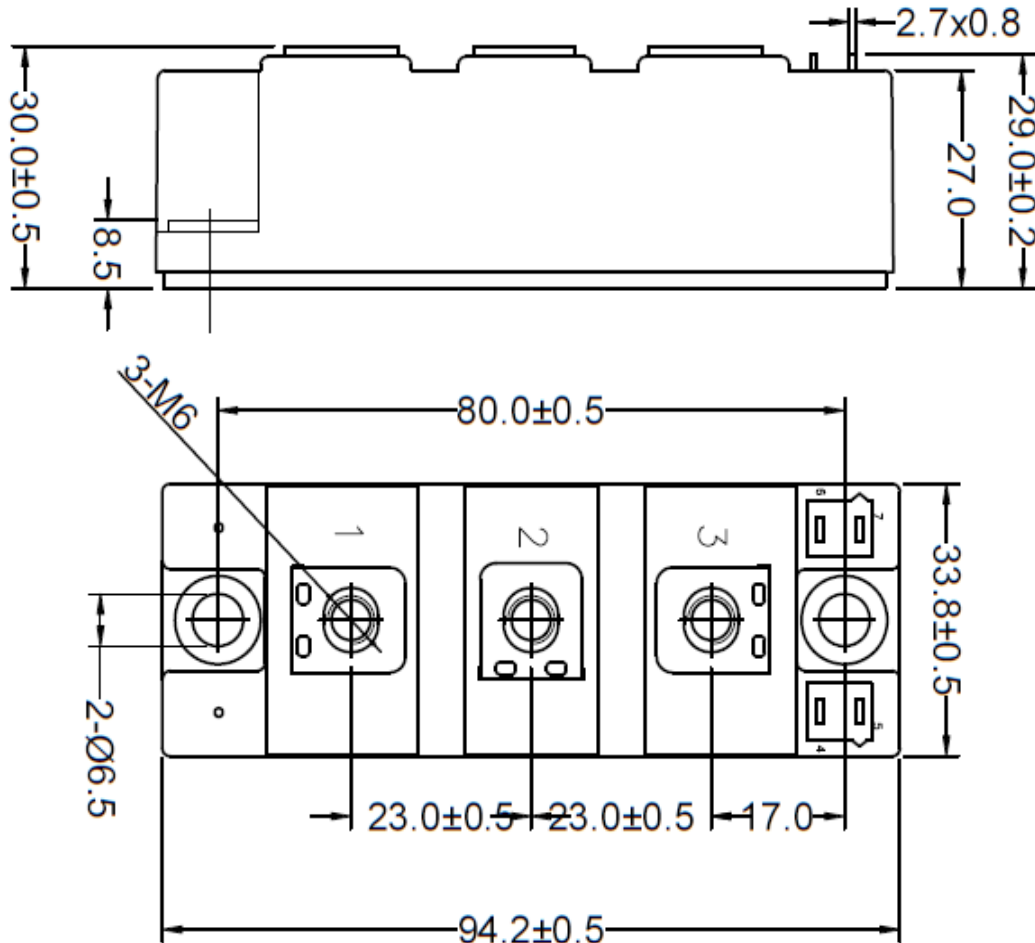

Figure 6. SCR Gate Characteristics



Dimensions in (mm)  
 Figure 7. Package Outline