

### Features

- Epitaxial Planar Die Construction
- Complementary NPN Types Available (MMSTA13/MMSTA14)
- Ultra-Small Surface Mount Package
- Ideal for Medium Power Amplification and Switching
- High Current Gain
- **Lead Free/RoHS Compliant (Note 2)**
- **"Green" Device (Note 3 and 4)**

### Mechanical Data

- Case: SOT-323
- Case Material: Molded Plastic, "Green" Molding Compound, Note 4. UL Flammability Classification Rating 94V-0
- Moisture Sensitivity: Level 1 per J-STD-020C
- Terminal Connections: See Diagram
- Terminals: Solderable per MIL-STD-202, Method 208
- Lead Free Plating (Matte Tin Finish annealed over Alloy 42 leadframe).
- MMSTA63 Marking K2E, K3E (See Page 3)
- MMSTA64 Marking K3E (see Page 3)
- Ordering & Date Code Information: See Page 3
- Weight: 0.006 grams (approximate)

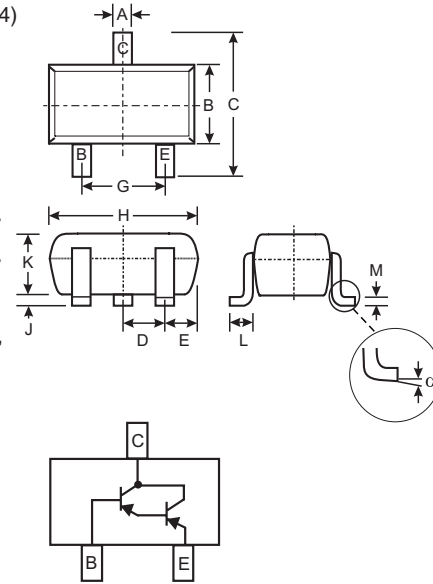

SOT-323		
Dim	Min	Max
A	0.25	0.40
B	1.15	1.35
C	2.00	2.20
D	0.65 Nominal	
E	0.30	0.40
G	1.20	1.40
H	1.80	2.20
J	0.0	0.10
K	0.90	1.00
L	0.25	0.40
M	0.10	0.18
$\alpha$	0°	8°
All Dimensions in mm		

### Maximum Ratings @ T<sub>A</sub> = 25°C unless otherwise specified

Characteristic	Symbol	Value	Unit
Collector-Base Voltage	V <sub>CBO</sub>	-30	V
Collector-Emitter Voltage	V <sub>CEO</sub>	-30	V
Emitter-Base Voltage	V <sub>EBO</sub>	-10	V
Collector Current - Continuous	I <sub>C</sub>	-500	mA
Power Dissipation (Note 1)	P <sub>d</sub>	200	mW
Thermal Resistance, Junction to Ambient (Note 1)	R <sub>θJA</sub>	625	°C/W
Operating and Storage and Temperature Range	T <sub>J</sub> , T <sub>STG</sub>	-55 to +150	°C

- Note:
1. Device mounted on FR-4 PCB, 1 inch x 0.85 inch x 0.062 inch; pad layout as shown on Diodes Inc. suggested pad layout document AP02001, which can be found on our website at <http://www.diodes.com/datasheets/ap02001.pdf>.
  2. No purposefully added lead.
  3. Diodes Inc.'s "Green" policy can be found on our website at [http://www.diodes.com/products/lead\\_free/index.php](http://www.diodes.com/products/lead_free/index.php)
  4. Product manufactured with Date Code 0609 (week 9, 2006) and newer are built with Green Molding Compound. Product manufactured prior to Date Code 0609 are built with Non-Green Molding Compound and may contain Halogens or Sb2O3 Fire Retardants.

## Electrical Characteristics @ $T_A = 25^\circ\text{C}$ unless otherwise specified

Characteristic	Symbol	Min	Max	Unit	Test Condition
<b>OFF CHARACTERISTICS (Note 5)</b>					
Collector-Emitter Breakdown Voltage	$V_{(BR)CEO}$	-30	—	V	$I_C = -100\mu\text{A}$ , $V_{BE} = 0\text{V}$
Collector Cutoff Current	$I_{CBO}$	—	-100	nA	$V_{CB} = -30\text{V}$ , $I_E = 0$
Emitter Cutoff Current	$I_{EBO}$	—	-100	nA	$V_{EB} = -10\text{V}$ , $I_C = 0$
<b>ON CHARACTERISTICS (Note 5)</b>					
DC Current Gain	MMSTA63 MMSTA64 MMSTA63 MMSTA64	$h_{FE}$	5,000 10,000 10,000 20,000	—	$I_C = -10\text{mA}$ , $V_{CE} = -5.0\text{V}$ $I_C = -10\text{mA}$ , $V_{CE} = -5.0\text{V}$ $I_C = -100\text{mA}$ , $V_{CE} = -5.0\text{V}$ $I_C = -100\text{mA}$ , $V_{CE} = -5.0\text{V}$
Collector-Emitter Saturation Voltage	$V_{CE(SAT)}$	—	-1.5	V	$I_C = -100\text{mA}$ , $I_B = -100\mu\text{A}$
Base- Emitter Saturation Voltage	$V_{BE(SAT)}$	—	-2.0	V	$I_C = -100\text{mA}$ , $V_{CE} = -5.0\text{V}$
<b>SMALL SIGNAL CHARACTERISTICS</b>					
Current Gain-Bandwidth Product	$f_T$	125	—	MHz	$V_{CE} = -5.0\text{V}$ , $I_C = -10\text{mA}$ , $f = 100\text{MHz}$

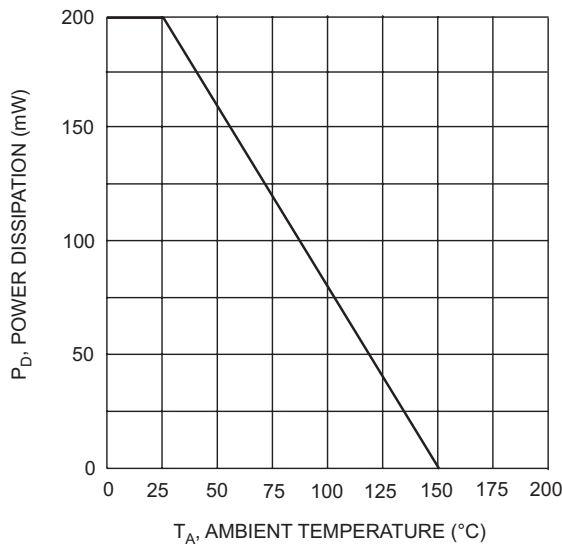

Fig. 1, Max Power Dissipation vs Ambient Temperature

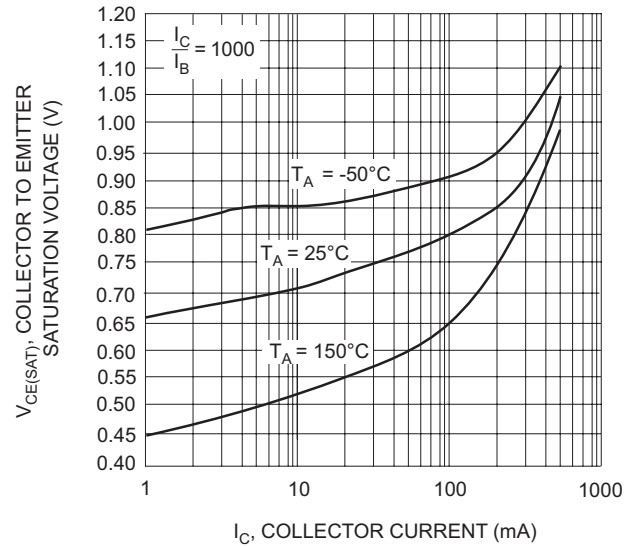

Fig. 2, Collector Emitter Saturation Voltage vs. Collector Current

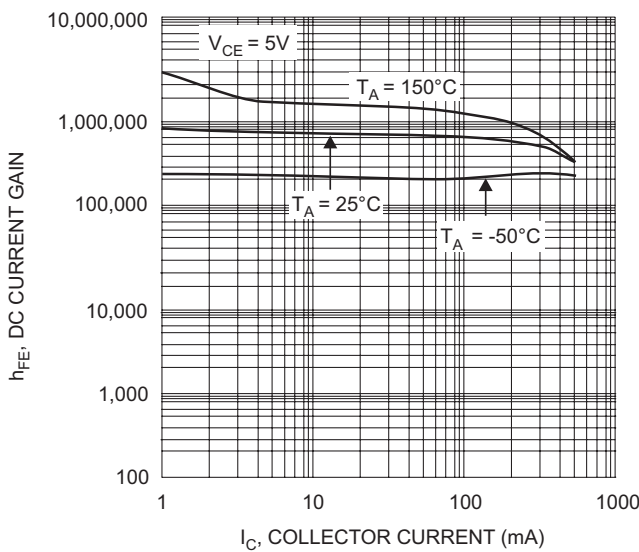

Fig. 3, DC Current Gain vs Collector Current

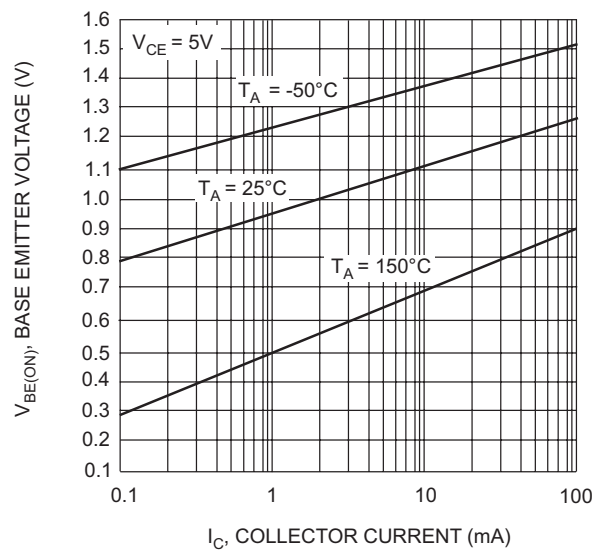

Fig. 4, Base Emitter Voltage vs. Collector Current

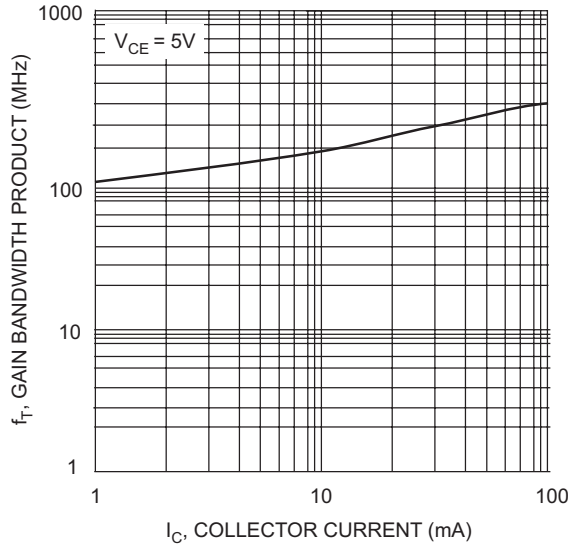

Fig. 5, Gain Bandwidth Product vs. Collector Current

### Ordering Information (Note 4 & 6)

Device	Packaging	Shipping
MMSTA63-7-F	SOT-323	3000/Tape & Reel
MMSTA64-7-F	SOT-323	3000/Tape & Reel

- Notes:
- Product manufactured with Date Code 0609 (week 9, 2006) and newer are built with Green Molding Compound. Product manufactured prior to Date Code 0609 are built with Non-Green Molding Compound and may contain Halogens or Sb2O3 Fire Retardants.
  - Short duration test pulse used to minimize self-heating effect.
  - For Packaging Details, go to our website at <http://www.diodes.com/datasheets/ap02007.pdf>.

### Marking Information

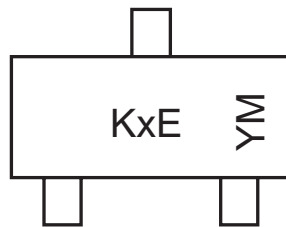

KxE = Product Type Marking Code, e.g. K2E = MMSTA63  
 YM = Date Code Marking  
 Y = Year ex: N = 2002  
 M = Month ex: 9 = September

#### Date Code Key

<b>Year</b>	1998	1999	2000	2001	2002	2003	2004	2005	2006	2007	2008	2009	2010	2011	2012
<b>Code</b>	J	K	L	M	N	P	R	S	T	U	V	W	X	Y	Z
<b>Month</b>	Jan	Feb	March	Apr	May	Jun	Jul	Aug	Sep	Oct	Nov	Dec			
<b>Code</b>	1	2	3	4	5	6	7	8	9	O	N	D			

IMPORTANT NOTICE

Diodes Incorporated and its subsidiaries reserve the right to make modifications, enhancements, improvements, corrections or other changes without further notice to any product herein. Diodes Incorporated does not assume any liability arising out of the application or use of any product described herein; neither does it convey any license under its patent rights, nor the rights of others. The user of products in such applications shall assume all risks of such use and will agree to hold Diodes Incorporated and all the companies whose products are represented on our website, harmless against all damages.

LIFE SUPPORT

Diodes Incorporated products are not authorized for use as critical components in life support devices or systems without the expressed written approval of the President of Diodes Incorporated.