

SOD-123 Plastic-Encapsulate Diodes

MMSZ4678-MMSZ4717 ZENER DIODE

SOD-123

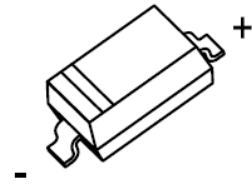

Features

- Pb-Free Packages are Available
- Wide Zener Reverse Voltage Range
- Small Package Size for High Density Applications
- ESD Rating of Class 3 (>16 kV) per Human Body Model

Maximum Ratings ($T_a = 25^\circ\text{C}$ unless otherwise specified)

Characteristic	Symbol	Value	Unit
Forward voltage @ $I_F = 10\text{mA}$	V_F	0.9	V
Power Dissipation	P_D	350	mW
Thermal Resistance, Junction to Ambient Air	$R_{\theta JA}$	357	$^\circ\text{C/W}$
Junction Temperature	T_j	150	$^\circ\text{C}$
Storage Temperature Range	T_{stg}	-55 ~ +150	$^\circ\text{C}$

Notes: Device mounted on ceramic PCB; 5.0mm×7.0mm with pad areas 35 mm²

ELECTRICAL CHARACTERISTICS ($T_a = 25^\circ\text{C}$ unless otherwise noted)

symbol	Parameter
V_Z	Reverse zener voltage @ I_{ZT}
I_{ZT}	Reverse current
I_R	Reverse leakage current @ V_R
V_R	Reverse voltage
I_F	Forward current
V_F	Forward voltage @ I_F

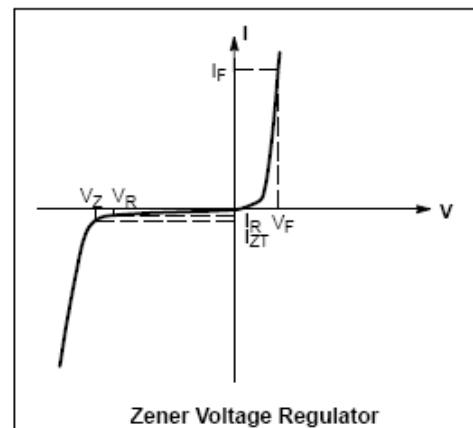

ELECTRICAL CHARACTERISTICS

$T_a=25^\circ\text{C}$ unless otherwise specified

Device	Device Marking	Zener Voltage (Notes 1)				Leakage Current	
		V_Z (Volts)			@ I_{ZT}	$I_R @ V_R$	
		Min	Nom	Max	μA	μA	Volts
MMSZ4678	CC	1.71	1.8	1.89	50	7.5	1
MMSZ4679	CD	1.90	2.0	2.10	50	5	1
MMSZ4680	CE	2.09	2.2	2.31	50	4	1
MMSZ4681	CF	2.28	2.4	2.52	50	2	1
MMSZ4682	CH	2.565	2.7	2.835	50	1	1
MMSZ4683	CJ	2.85	3.0	3.15	50	0.8	1
MMSZ4684	CK	3.13	3.3	3.47	50	7.5	1.5
MMSZ4685	CM	3.42	3.6	3.78	50	7.5	2
MMSZ4686	CN	3.70	3.9	4.10	50	5	2
MMSZ4687	CP	4.09	4.3	4.52	50	4	2
MMSZ4688	CT	4.47	4.7	4.94	50	10	3
MMSZ4689	CU	4.85	5.1	5.36	50	10	3
MMSZ4690	CV	5.32	5.6	5.88	50	10	4
MMSZ4691	CA	5.89	6.2	6.51	50	10	5
MMSZ4692	CX	6.46	6.8	7.14	50	10	5.1
MMSZ4693	CY	7.13	7.5	7.88	50	10	5.7
MMSZ4694	CZ	7.79	8.2	8.61	50	1	6.2
MMSZ4695	DC	8.27	8.7	9.14	50	1	6.6
MMSZ4696	DD	8.65	9.1	9.56	50	1	6.9
MMSZ4697	DE	9.50	10	10.50	50	1	7.6
MMSZ4698	DF	10.45	11	11.55	50	0.05	8.4
MMSZ4699	DH	11.40	12	12.60	50	0.05	9.1
MMSZ4700	DJ	12.35	13	13.65	50	0.05	9.8
MMSZ4701	DK	13.30	14	14.70	50	0.05	10.6
MMSZ4702	DM	14.25	15	15.75	50	0.05	11.4
MMSZ4703*	DN	15.20	16	16.80	50	0.05	12.1
MMSZ4704	DP	16.15	17	17.85	50	0.05	12.9
MMSZ4705	DT	17.10	18	18.90	50	0.05	13.6
MMSZ4706	DU	18.05	19	19.95	50	0.05	14.4
MMSZ4707	DV	19.00	20	21.00	50	0.01	15.2
MMSZ4708	DA	20.90	22	23.10	50	0.01	16.7
MMSZ4709	DX	22.80	24	25.20	50	0.01	18.2
MMSZ4710	DY	23.75	25	26.25	50	0.01	19.0
MMSZ4711*	EA	25.65	27	28.35	50	0.01	20.4
MMSZ4712	EC	26.60	28	29.40	50	0.01	21.2
MMSZ4713	ED	28.50	30	31.50	50	0.01	22.8
MMSZ4714	EE	31.35	33	34.65	50	0.01	25.0
MMSZ4715	EF	34.20	36	37.80	50	0.01	27.3
MMSZ4716	EH	37.05	39	40.95	50	0.01	29.6
MMSZ4717	EJ	40.85	43	45.15	50	0.01	32.6

1. Nominal Zener voltage is measured with the device junction in thermal equilibrium at $T_L = 30^\circ\text{C} \pm 1^\circ\text{C}$

SOD-123 Package Outline Dimensions

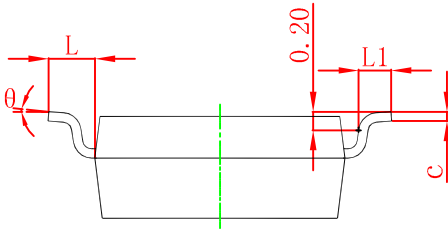
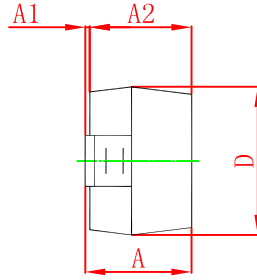
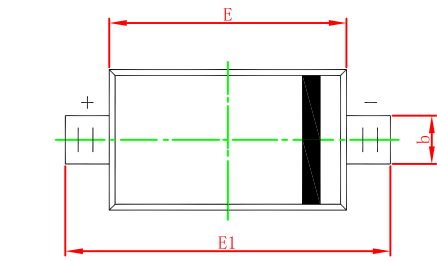

Symbol	Dimensions In Millimeters		Dimensions In Inches	
	Min	Max	Min	Max
A	1.050	1.250	0.041	0.049
A1	0.000	0.100	0.000	0.004
A2	1.050	1.150	0.041	0.045
b	0.450	0.650	0.018	0.026
c	0.080	0.150	0.003	0.006
D	1.500	1.700	0.059	0.067
E	2.600	2.800	0.102	0.110
E1	3.550	3.850	0.140	0.152
L	0.500 REF		0.020 REF	
L1	0.250	0.450	0.010	0.018
θ	0°	8°	0°	8°

SOD-123 Suggested Pad Layout

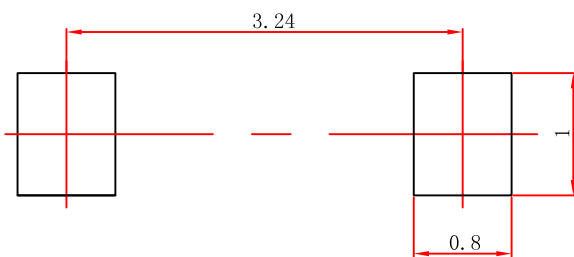

Note:

1. Controlling dimension: in millimeters.
2. General tolerance: $\pm 0.05\text{mm}$.
3. The pad layout is for reference purposes only.

NOTICE

JCET reserve the right to make modifications, enhancements, improvements, corrections or other changes without further notice to any product herein. JCET does not assume any liability arising out of the application or use of any product described herein.

SOD-123 Tape and Reel

SOD-123 Embossed Carrier Tape

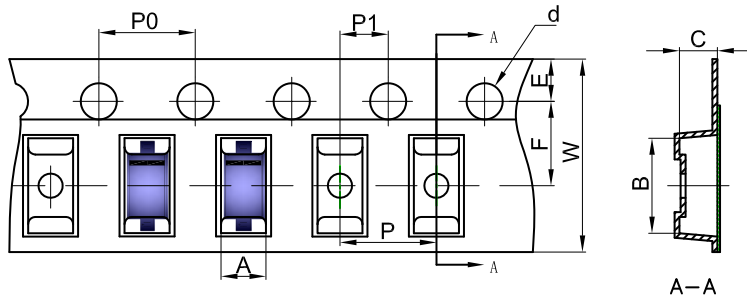

Packaging Description:

SOD-123 parts are shipped in tape. The carrier tape is made from a dissipative (carbon filled) polycarbonate resin. The cover tape is a multilayer film (Heat Activated Adhesive in nature) primarily composed of polyester film, adhesive layer, sealant, and anti-static sprayed agent. These reeled parts in standard option are shipped with 3,000 units per 7" or 17.8cm diameter reel. The reels are clear in color and is made of polystyrene plastic (anti-static coated).

Dimensions are in millimeter											
Pkg type	A	B	C	d	E	F	P0	P	P1	W	
SOD-123	1.85	3.95	1.57	Ø1.55	1.75	3.50	4.00	4.00	2.00	8.00	

SOD-123 Tape Leader and Trailer

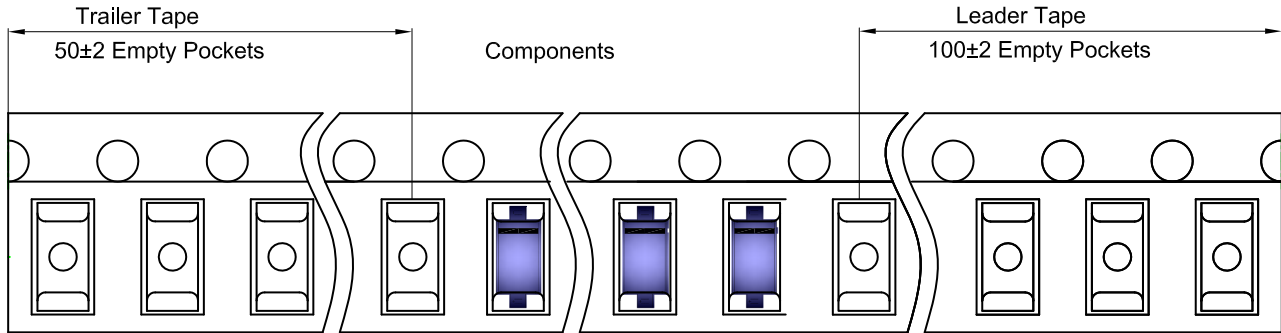

SOD-123 Reel

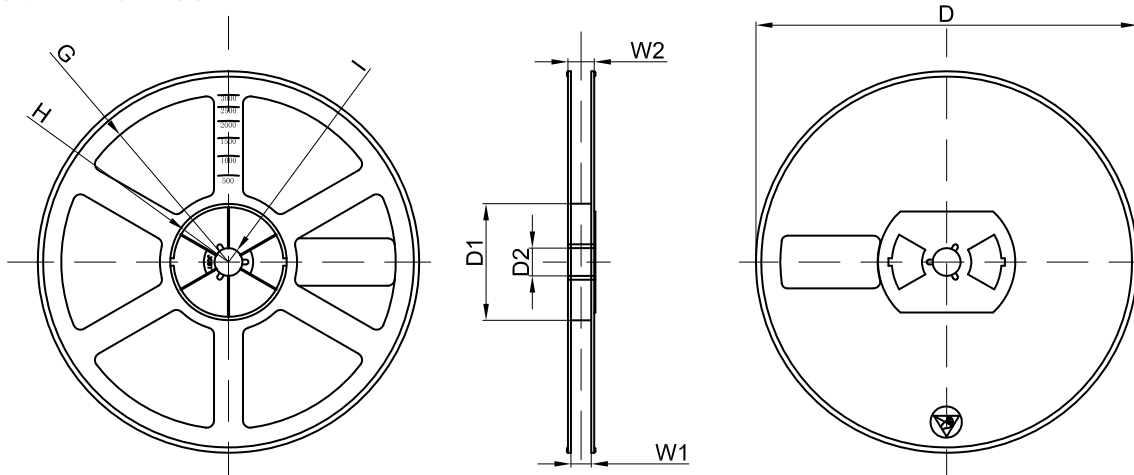

Dimensions are in millimeter								
Reel Option	D	D1	D2	G	H	I	W1	W2
7" Dia	Ø178.00	54.40	13.00	R78.00	R25.60	R6.50	9.50	12.30

REEL	Reel Size	Box	Box Size(mm)	Carton	Carton Size(mm)	G.W.(kg)
3000 pcs	7 inch	45,000 pcs	203×203×195	180,000 pcs	438×438×220	