

MMSZ5221BS-FL THRU MMSZ5267BS-FL

List

List..... 1

Package outline..... 2

Features..... 2

Mechanical data..... 2

Maximum ratings 2

Electrical characteristics..... 3

Rating and characteristic curves..... 4~5

Pinning information..... 6

Suggested solder pad layout..... 6

Packing information..... 7

Reel packing..... 8

Suggested thermal profiles for soldering processes..... 8

High reliability test capabilities..... 9

MMSZ5221BS-FL THRU MMSZ5267BS-FL**200mW Surface Mount Zener
Diodes - 2.4V-75V****Package outline****Features**

- Wide Zener Voltage Range Selection, 2.4V to 75V.
- VZ Tolerance Selection of $\pm 5\%$.
- Flat Lead SOD-323FL Plastic Package.
- Surface Device Type Mounting.
- Lead-free parts meet environmental standards of MIL-STD-19500 / 228
- Suffix "-H" indicates Halogen free parts, ex. MMSZ5221BS-FL-H.

Mechanical data

- Epoxy : UL94-V0 rated flame retardant
- Case : Molded plastic, SOD-323FL
- Terminals :Plated terminals, solderable per MIL-STD-750, Method 2026
- Polarity : Indicated by cathode band
- Mounting Position : Any
- Weight : Approximated 0.004 gram

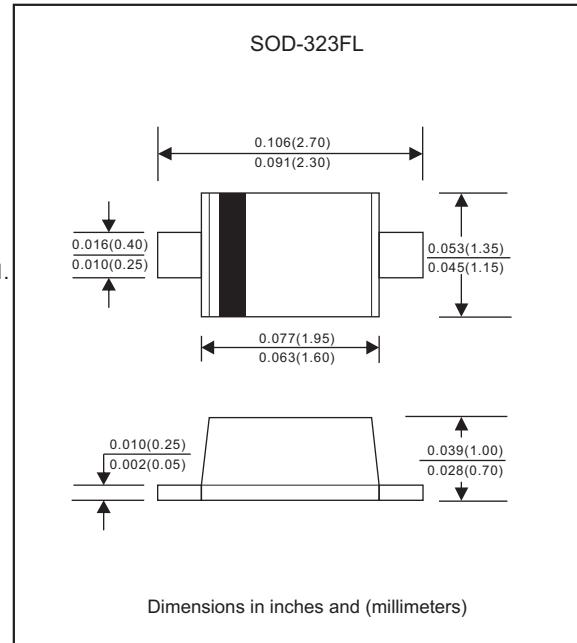
**Maximum ratings** (at $T_A=25^\circ\text{C}$ unless otherwise noted)

PARAMETER	CONDITIONS	Symbol	MIN.	TYP.	MAX.	UNIT
Forward voltage	$I_F = 10 \text{ mA}$	V_F			0.90	V
Power Dissipation		P_D			200	mW
Operating temperature		T_J	-65		+150	$^\circ\text{C}$
Storage temperature		T_{STG}	-65		+150	$^\circ\text{C}$

MMSZ5221BS-FL THRU MMSZ5267BS-FL

Electrical characteristics (at $T_A=25^\circ\text{C}$ unless otherwise noted)

Part No.	Marking code	Zener voltage			Test current	Zener impedance			Leakage current	
		$V_Z @ I_{ZT}$ (Volts)				I_{ZT}	$Z_{ZT} @ I_{ZT}$	$Z_{ZK} @ I_{ZK}$	I_{ZK}	I_R
		Min	Nom	Max	mA	(Ω)Max	(Ω)Max	mA	(μA)Max	Volts
MMSZ5221BS-FL	Z2V4,C1	2.28	2.4	2.52	20.0	30	1200	0.25	100	1.0
MMSZ5222BS-FL	Z2V5,C2	2.38	2.5	2.63	20.0	30	1250	0.25	100	1.0
MMSZ5223BS-FL	Z2V7,C3	2.57	2.7	2.84	20.0	30	1300	0.25	75	1.0
MMSZ5224BS-FL	Z2V8	2.66	2.8	2.94	20.0	30	1400	0.25	75	1.0
MMSZ5225BS-FL	Z3V0,C5	2.85	3.0	3.15	20.0	29	1600	0.25	50	1.0
MMSZ5226BS-FL	Z3V3,D1	3.14	3.3	3.47	20.0	28	1600	0.25	25	1.0
MMSZ5227BS-FL	Z3V6,D2	3.42	3.6	3.78	20.0	24	1700	0.25	15	1.0
MMSZ5228BS-FL	Z3V9,D3	3.71	3.9	4.10	20.0	23	1900	0.25	10	1.0
MMSZ5229BS-FL	Z4V3,D4	4.09	4.3	4.52	20.0	22	2000	0.25	5.0	1.0
MMSZ5230BS-FL	Z4V7,D5	4.47	4.7	4.94	20.0	19	1900	0.25	5.0	2.0
MMSZ5231BS-FL	Z5V1,E1	4.85	5.1	5.36	20.0	17	1600	0.25	5.0	2.0
MMSZ5232BS-FL	Z5V6,E2	5.32	5.6	5.88	20.0	11	1600	0.25	5.0	3.0
MMSZ5233BS-FL	Z6V0	5.70	6.0	6.30	20.0	7	1600	0.25	5.0	3.5
MMSZ5234BS-FL	Z6V2,E4	5.89	6.2	6.51	20.0	7	1000	0.25	5.0	4.0
MMSZ5235BS-FL	Z6V8,E5	6.46	6.8	7.14	20.0	5	750	0.25	3.0	5.0
MMSZ5236BS-FL	Z7V5,F1	7.13	7.5	7.88	20.0	6	500	0.25	3.0	6.0
MMSZ5237BS-FL	Z8V2,F2	7.79	8.2	8.61	20.0	8	500	0.25	3.0	6.5
MMSZ5238BS-FL	Z8V7,F3	8.27	8.7	9.14	20.0	8	600	0.25	3.0	6.5
MMSZ5239BS-FL	Z9V1,F4	8.65	9.1	9.56	20.0	10	600	0.25	3.0	7.0
MMSZ5240BS-FL	Z10V,F5	9.50	10	10.50	20.0	17	600	0.25	3.0	8.0
MMSZ5241BS-FL	Z11V,H1	10.45	11	11.55	20.0	22	600	0.25	2.0	8.4
MMSZ5242BS-FL	Z12V,H2	11.40	12	12.60	20.0	30	600	0.25	1.0	9.1
MMSZ5243BS-FL	Z13V,H3	12.35	13	13.65	9.5	13	600	0.25	0.5	9.9
MMSZ5244BS-FL	Z14V,H4	13.30	14	14.70	9.0	15	600	0.25	0.1	10
MMSZ5245BS-FL	Z15V,H5	14.25	15	15.75	8.5	16	600	0.25	0.1	11
MMSZ5246BS-FL	Z16V,J1	15.20	16	16.80	7.8	17	600	0.25	0.1	12
MMSZ5247BS-FL	Z17V,J2	16.15	17	17.85	7.4	19	600	0.25	0.1	13
MMSZ5248BS-FL	Z18V,J3	17.10	18	18.90	7.0	21	600	0.25	0.1	14
MMSZ5249BS-FL	Z19V	18.05	19	19.95	6.6	23	600	0.25	0.1	14
MMSZ5250BS-FL	Z20V,J5	19.00	20	21.00	6.2	25	600	0.25	0.1	15
MMSZ5251BS-FL	Z22V,K1	20.90	22	23.10	5.6	29	600	0.25	0.1	17
MMSZ5252BS-FL	Z24V,K2	22.80	24	25.20	5.2	33	600	0.25	0.1	18
MMSZ5253BS-FL	Z25V	23.75	25	26.25	5.0	35	600	0.25	0.1	19
MMSZ5254BS-FL	Z27V,K4	25.65	27	28.35	4.6	41	600	0.25	0.1	21
MMSZ5255BS-FL	Z28V,K5	26.60	28	29.40	4.5	44	600	0.25	0.1	21
MMSZ5256BS-FL	Z30V,M1	28.50	30	31.50	4.2	49	600	0.25	0.1	23
MMSZ5257BS-FL	Z33V,M2	31.35	33	34.65	3.8	58	700	0.25	0.1	25
MMSZ5258BS-FL	Z36V,M3	34.20	36	37.80	3.4	70	700	0.25	0.1	27
MMSZ5259BS-FL	Z39V,M4	37.05	39	40.95	3.2	80	800	0.25	0.1	30
MMSZ5260BS-FL	Z43V,M5	40.85	43	45.15	3.0	93	900	0.25	0.1	33
MMSZ5261BS-FL	Z47V,N1	44.65	47	49.35	2.7	105	1000	0.25	0.1	36
MMSZ5262BS-FL	Z51V,N2	48.45	51	53.55	2.5	125	1100	0.25	0.1	39
MMSZ5263BS-FL	Z56V	53.20	56	58.80	2.2	150	1300	0.25	0.1	43
MMSZ5264BS-FL	Z60V	57.00	60	63.00	2.1	170	1400	0.25	0.1	46
MMSZ5265BS-FL	Z62V	58.90	62	65.10	2.0	185	1400	0.25	0.1	47
MMSZ5266BS-FL	Z68V	64.60	68	71.40	1.8	230	1600	0.25	0.1	52
MMSZ5267BS-FL	Z75V	71.45	75	78.45	1.7	270	1700	0.25	0.1	56

Note : 5% tolerance of Zener voltage

Rating and characteristic curves (MMSZ5221BS-FL THRU MMSZ5267BS-FL)

FIG. 1-POWER DISSIPATION VS. AMBIENT TEMP.

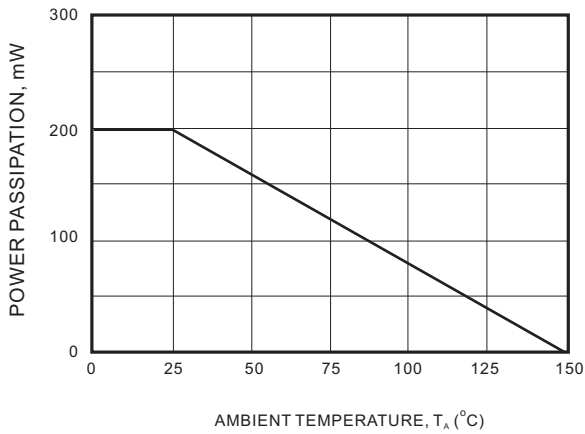

FIG. 2-EFFECT OF ZENER VOLTAGE ON ZENER IMPEDANCE

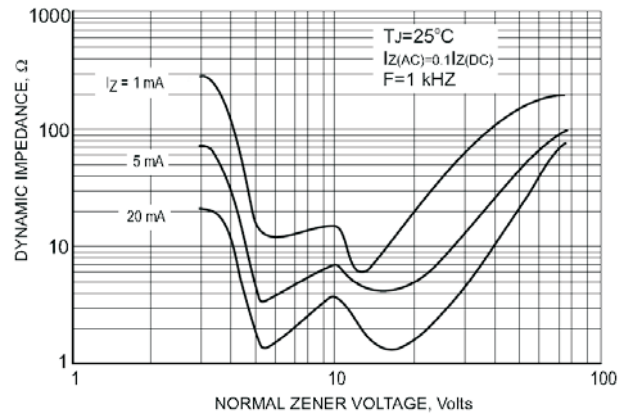

FIG. 3-TYPICAL FORWARD VOLTAGE

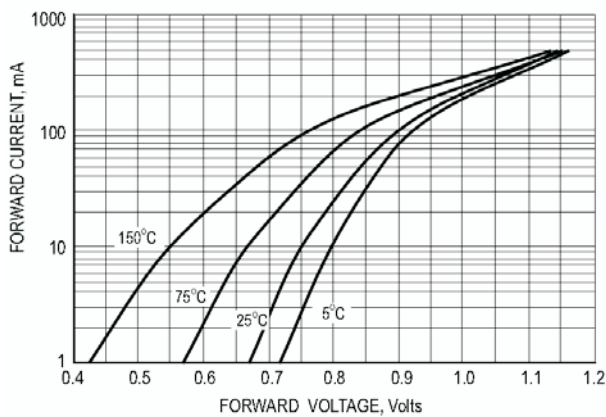

FIG. 4-TYPICAL CAPACITANCE

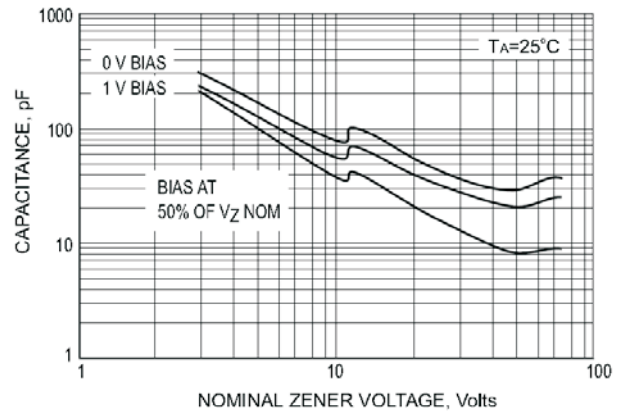

FIG. 5-ZENER BREAKDOWN CHARACTERISTICS

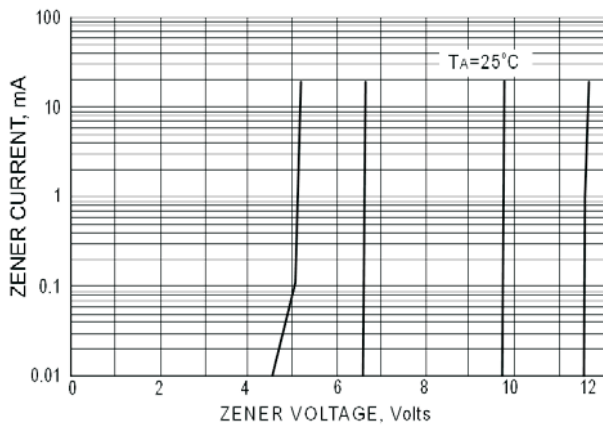
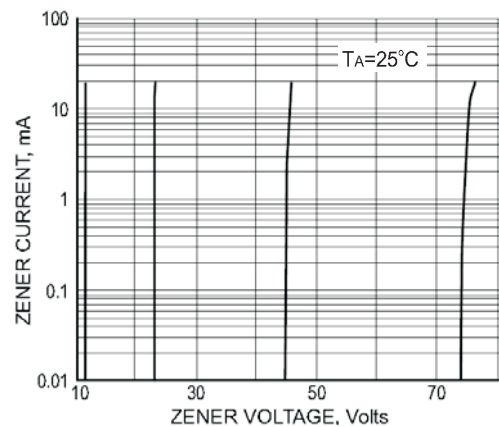
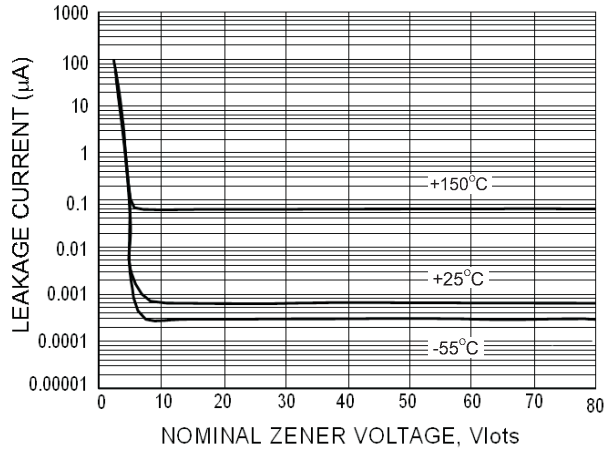

FIG. 6-ZENER BREAKDOWN CHARACTERISTICS





Rating and characteristic curves (MMSZ5221BS-FL THRU MMSZ5267BS-FL)

FIG. 7-TYPICAL LEAKGE CURRENT



MMSZ5221BS-FL THRU MMSZ5267BS-FL

Pinning information

Pin	Simplified outline	Symbol
Pin1 cathode Pin2 anode		

Suggested solder pad layout

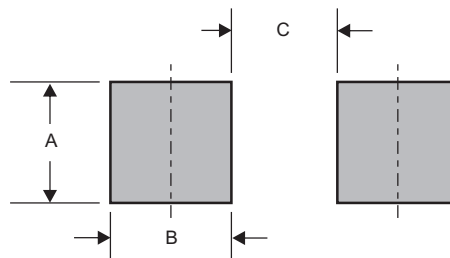

Dimensions in inches and (millimeters)

PACKAGE	A	B	C
SOD-323FL	0.032 (0.82)	0.022 (0.56)	0.069 (1.75)

MMSZ5221BS-FL THRU MMSZ5267BS-FL

Packing information

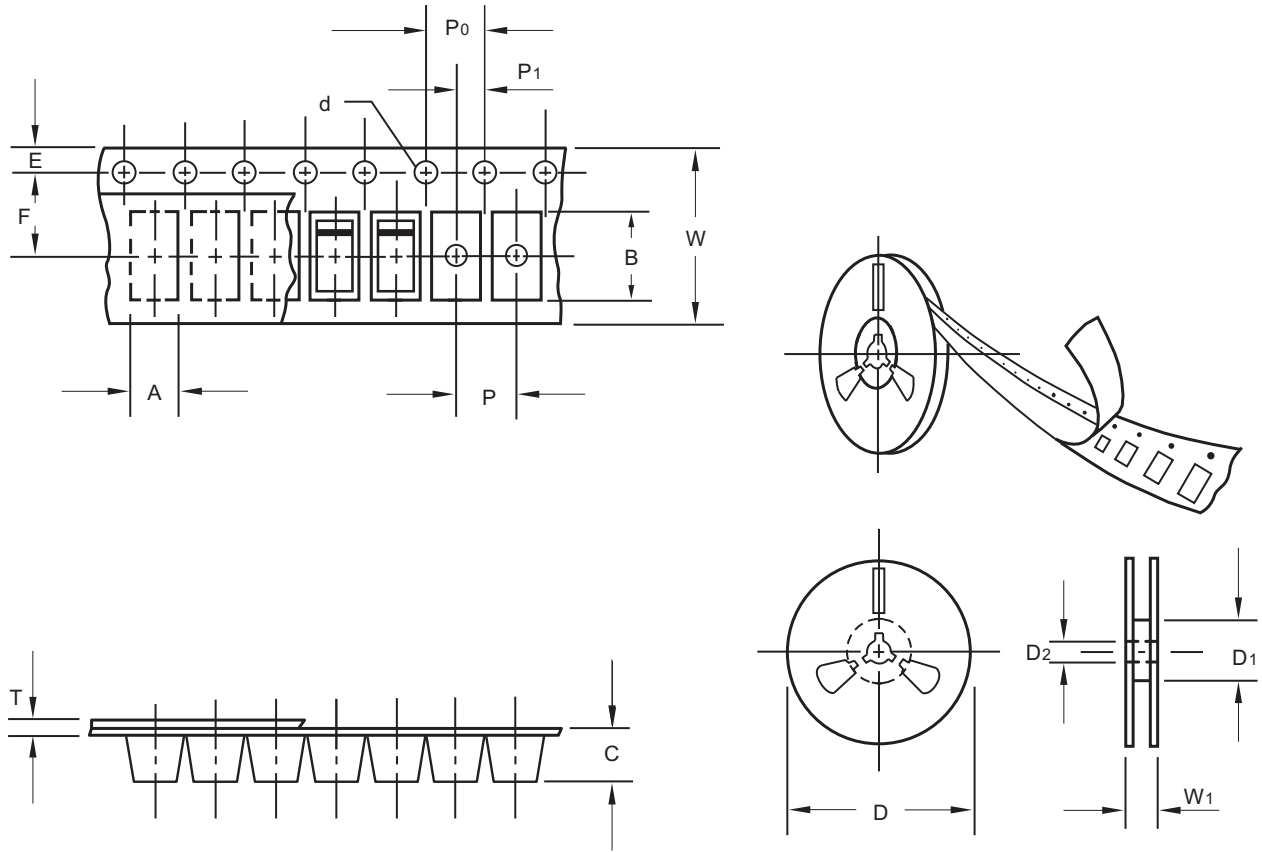

unit:mm

Item	Symbol	Tolerance	SOD-323FL
Carrier width	A	0.1	1.46
Carrier length	B	0.1	2.95
Carrier depth	C	0.1	1.25
Sprocket hole	d	0.1	1.50
13" Reel outside diameter	D	2.0	-
13" Reel inner diameter	D1	min	-
7" Reel outside diameter	D	2.0	178.00
7" Reel inner diameter	D1	min	62.00
Feed hole diameter	D2	0.5	13.00
Sprocket hole position	E	0.1	1.75
Punch hole position	F	0.1	3.50
Punch hole pitch	P	0.1	4.00
Sprocket hole pitch	P0	0.1	4.00
Embossment center	P1	0.1	2.00
Overall tape thickness	T	0.1	0.23
Tape width	W	0.3	8.00
Reel width	W1	1.0	11.40

Note: Devices are packed in accordance with EIA standard RS-481-A and specifications listed above.

MMSZ5221BS-FL THRU MMSZ5267BS-FL

Reel packing

PACKAGE	REEL SIZE	REEL (pcs)	COMPONENT SPACING (m/m)	BOX (pcs)	INNER BOX (m/m)	REEL DIA, (m/m)	CARTON SIZE (m/m)	CARTON (pcs)	APPROX. GROSS WEIGHT (kg)
SOD-323FL	7"	3,000	4.0	30,000	183*183*123	178	382*262*387	240,000	9.5
		5,000	4.0	50,000	183*183*123	178	382*262*387	400,000	15.2

Suggested thermal profiles for soldering processes

- 1.Storage environment: Temperature=5°C~40°C Humidity=55%±25%
- 2.Reflow soldering of surface-mount devices

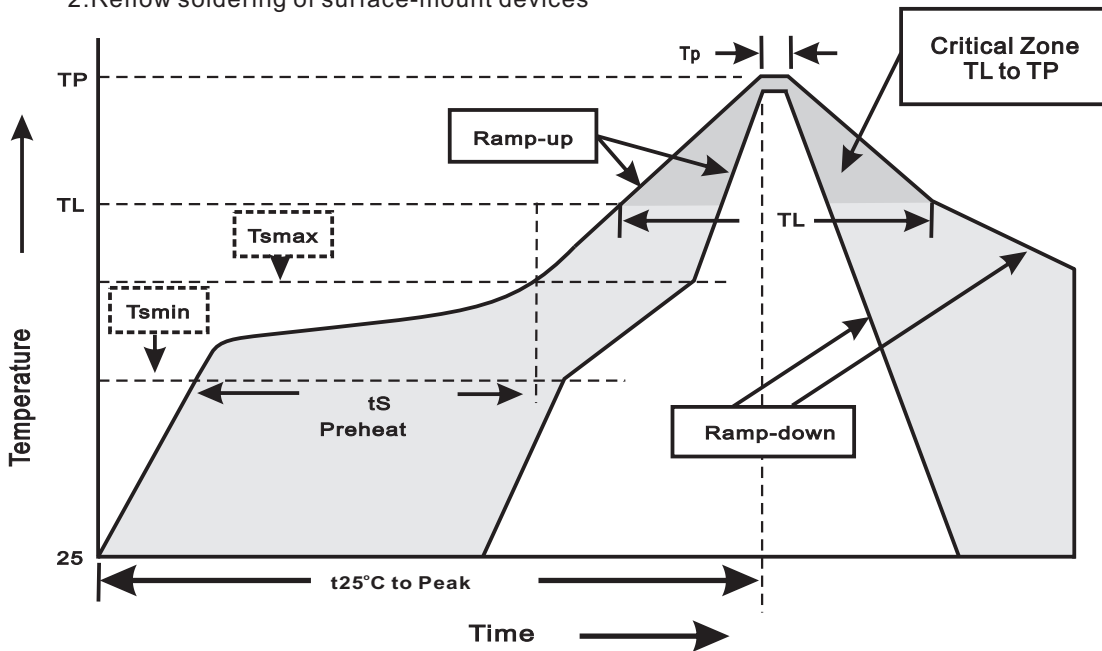

3.Reflow soldering

Profile Feature	Soldering Condition
Average ramp-up rate(T _L to T _P)	<3°C/sec
Preheat -Temperature Min(T _{sm}) -Temperature Max(T _{sm}) -Time(min to max)(t _s)	150°C 200°C 60~120sec
T _{sm} to T _L -Ramp-upRate	<3°C/sec
Time maintained above: -Temperature(T _L) -Time(t _L)	217°C 60~260sec
Peak Temperature(T _P)	255°C-0/+5°C
Time within 5°C of actual Peak Temperature(t _p)	10~30sec
Ramp-down Rate	<6°C/sec
Time 25°C to Peak Temperature	<6minutes

MMSZ5221BS-FL THRU MMSZ5267BS-FL**High reliability test capabilities**

Item Test	Conditions	Reference
1. Solder Resistance	at 260±5°C for 10±2sec. immerse body into solder 1/16"±1/32"	MIL-STD-750D METHOD-2031
2. Solderability	at 245±5°C for 5 sec.	MIL-STD-202F METHOD-208
3. High Temperature Reverse Bias	$V_R=80\%$ rate at $T_J=150^\circ\text{C}$ for 168 hrs.	MIL-STD-750D METHOD-1038
4. Pressure Cooker	15P _{SI6} at $T_A=121^\circ\text{C}$ for 4 hrs.	JESD22-A102
5. Temperature Cycling	-55°C to +125°C dwelled for 30 min. and transferred for 5min. total 10 cycles.	MIL-STD-750D METHOD-1051
6. Thermal Shock	0°C for 5 min. rise to 100°C for 5 min. total 10 cycles.	MIL-STD-750D METHOD-1056
7. Humidity	at $T_A=85^\circ\text{C}$, RH=85% for 1000hrs.	MIL-STD-750D METHOD-1021
8. High Temperature Storage Life	at 175°C for 1000 hrs.	MIL-STD-750D METHOD-1031