

MMSZ5221-FL THRU MMSZ5267-FL

List

List..... 1

Package outline..... 2

Features..... 2

Mechanical data..... 2

Maximum ratings 2

Electrical characteristics..... 3~4

Rating and characteristic curves..... 5~6

Pinning information..... 7

Suggested solder pad layout..... 7

Packing information..... 8

Reel packing..... 9

Suggested thermal profiles for soldering processes..... 9

High reliability test capabilities..... 10

MMSZ5221-FL THRU MMSZ5267-FL

500mW Surface Mount Zener
Diodes - 2.4V- 75V

Features

- Wide Zener Voltage Range Selection, 4.3V to 75V of $\pm 2\%$.
- Wide Zener Voltage Range Selection, 2.4V to 75V of $\pm 5\%$.
- Flat Lead SOD-123FL Plastic Package.
- Surface Device Type Mounting.
- Lead-free parts meet environmental standards of MIL-STD-19500 /228
- Suffix "-H" indicates Halogen free parts, ex. MMSZ5229A-FL-H.

Mechanical data

- Epoxy:UL94-VO rated flame retardant
- Case : Molded plastic, SOD-123FL
- Terminals : Solder plated, solderable per MIL-STD-750, Method 2026
- Polarity : Indicated by cathode band
- Mounting Position : Any
- Weight : Approximated 0.009 gram

Package outline

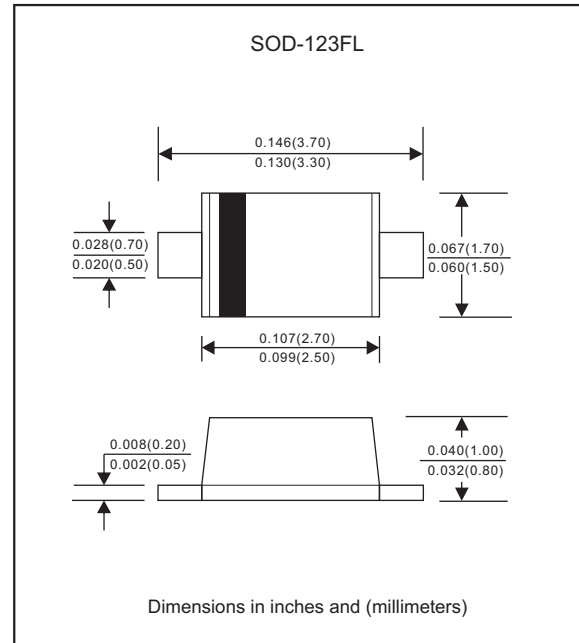

Maximum ratings (at $T_A=25^\circ\text{C}$ unless otherwise noted)

PARAMETER	CONDITIONS	Symbol	MIN.	TYP.	MAX.	UNIT
Forward voltage	$I_F = 10 \text{ mA}$	V_F			0.90	V
Power Dissipation		P_D			500	mW
Operating temperature		T_J	-65		+150	$^\circ\text{C}$
Storage temperature		T_{STG}	-65		+150	$^\circ\text{C}$

MMSZ5221-FL THRU MMSZ5267-FL

Electrical characteristics (at $T_A=25^\circ\text{C}$ unless otherwise noted)

MMSZ5229A-FL thru MMSZ5267A-FL

Part No.	Marking code	Zener voltage			Test current	Zener impedance			Leakage current	
		$V_Z @ I_{ZT}$ (Volts)			I_{ZT}	$Z_{ZT} @ I_{ZT}$	$Z_{ZK} @ I_{ZK}$	I_{ZK}	I_R	V_R
		Min	Nom	Max	mA	(Ω)Max	(Ω)Max	mA	(μA)Max	Volts
MMSZ5229A-FL	229C	4.214	4.3	4.386	20.0	22	2000	0.25	5.0	1.0
MMSZ5230A-FL	230C	4.606	4.7	4.794	20.0	19	1900	0.25	5.0	2.0
MMSZ5231A-FL	231C	4.998	5.1	5.202	20.0	17	1600	0.25	5.0	2.0
MMSZ5232A-FL	232C	5.488	5.6	5.712	20.0	11	1600	0.25	5.0	3.0
MMSZ5233A-FL	233C	5.880	6.0	6.120	20.0	7	1600	0.25	5.0	3.5
MMSZ5234A-FL	234C	6.076	6.2	6.324	20.0	7	1000	0.25	5.0	4.0
MMSZ5235A-FL	235C	6.664	6.8	6.936	20.0	5	750	0.25	3.0	5.0
MMSZ5236A-FL	236C	7.350	7.5	7.650	20.0	6	500	0.25	3.0	6.0
MMSZ5237A-FL	237C	8.036	8.2	8.364	20.0	8	500	0.25	3.0	6.5
MMSZ5238A-FL	238C	8.526	8.7	8.874	20.0	8	600	0.25	3.0	6.5
MMSZ5239A-FL	239C	8.918	9.1	9.282	20.0	10	600	0.25	3.0	7.0
MMSZ5240A-FL	240C	9.80	10	10.20	20.0	17	600	0.25	3.0	8.0
MMSZ5241A-FL	241C	10.78	11	11.22	20.0	22	600	0.25	2.0	8.4
MMSZ5242A-FL	242C	11.76	12	12.24	20.0	30	600	0.25	1.0	9.1
MMSZ5243A-FL	243C	12.74	13	13.26	9.5	13	600	0.25	0.5	9.9
MMSZ5244A-FL	244C	13.72	14	14.28	9.0	15	600	0.25	0.1	10
MMSZ5245A-FL	245C	14.70	15	15.30	8.5	16	600	0.25	0.1	11
MMSZ5246A-FL	246C	15.68	16	16.32	7.8	17	600	0.25	0.1	12
MMSZ5247A-FL	247C	16.66	17	17.34	7.4	19	600	0.25	0.1	13
MMSZ5248A-FL	248C	17.64	18	18.36	7.0	21	600	0.25	0.1	14
MMSZ5249A-FL	249C	18.62	19	19.38	6.6	23	600	0.25	0.1	14
MMSZ5250A-FL	250C	19.60	20	20.40	6.2	25	600	0.25	0.1	15
MMSZ5251A-FL	251C	21.56	22	22.44	5.6	29	600	0.25	0.1	17
MMSZ5252A-FL	252C	23.52	24	24.48	5.2	33	600	0.25	0.1	18
MMSZ5253A-FL	253C	24.50	25	25.50	5.0	35	600	0.25	0.1	19
MMSZ5254A-FL	254C	26.46	27	27.54	4.6	41	600	0.25	0.1	21
MMSZ5255A-FL	255C	27.44	28	28.56	4.5	44	600	0.25	0.1	21
MMSZ5256A-FL	256C	29.40	30	30.60	4.2	49	600	0.25	0.1	23
MMSZ5257A-FL	257C	32.34	33	33.66	3.8	58	700	0.25	0.1	25
MMSZ5258A-FL	258C	35.28	36	36.72	3.4	70	700	0.25	0.1	27
MMSZ5259A-FL	259C	38.22	39	39.78	3.2	80	800	0.25	0.1	30
MMSZ5260A-FL	260C	42.14	43	43.86	3.0	93	900	0.25	0.1	33
MMSZ5261A-FL	261C	46.06	47	47.94	2.7	105	1000	0.25	0.1	36
MMSZ5262A-FL	262C	49.98	51	52.02	2.5	125	1100	0.25	0.1	39
MMSZ5263A-FL	263C	54.88	56	57.12	2.2	150	1300	0.25	0.1	43
MMSZ5264A-FL	264C	58.80	60	61.20	2.1	170	1400	0.25	0.1	46
MMSZ5265A-FL	265C	60.76	62	63.24	2.0	185	1400	0.25	0.1	47
MMSZ5266A-FL	266C	66.64	68	69.36	1.8	230	1600	0.25	0.1	52
MMSZ5267A-FL	267C	73.50	75	76.50	1.7	270	1700	0.25	0.1	56

Notes:

1. The zener voltage (V_Z) is tested under pulse condition of 1ms.
2. The device numCers listed have a standard tolerance on the nominal zener voltage of $\pm 2\%$.
3. The zener impedance is derived from the 60-cycle ac voltage, which results when an ac current having an rms value equal to 10% of the dc zener current (I_{ZT} or I_{ZK}) is superimposed to I_{ZT} or I_{ZK} .



MMSZ5221-FL THRU MMSZ5267-FLElectrical characteristics (at $T_A=25^{\circ}\text{C}$ unless otherwise noted)**MMSZ5221B-FL thru MMSZ5267B-FL**

Part No.	Marking code	Zener voltage			Test current	Zener impedance			Leakage current	
		$V_Z @ I_{ZT}(\text{Volts})$			I_{ZT}	$Z_{ZT} @ I_{ZT}$	$Z_{ZK} @ I_{ZK}$	I_{ZK}	I_R	V_R
		Min	Nom	Max	mA	(Ω)Max	(Ω)Max	mA	(μA)Max	Volts
MMSZ5221B-FL	Z2V4	2.28	2.4	2.52	20.0	30	1200	0.25	100	1.0
MMSZ5222B-FL	Z2V5	2.38	2.5	2.63	20.0	30	1250	0.25	100	1.0
MMSZ5223B-FL	Z2V7	2.57	2.7	2.84	20.0	30	1300	0.25	75	1.0
MMSZ5224B-FL	Z2V8	2.66	2.8	2.94	20.0	30	1400	0.25	75	1.0
MMSZ5225B-FL	Z3V0	2.85	3.0	3.15	20.0	29	1600	0.25	50	1.0
MMSZ5226B-FL	Z3V3	3.14	3.3	3.47	20.0	28	1600	0.25	25	1.0
MMSZ5227B-FL	Z3V6	3.42	3.6	3.78	20.0	24	1700	0.25	15	1.0
MMSZ5228B-FL	Z3V9	3.71	3.9	4.10	20.0	23	1900	0.25	10	1.0
MMSZ5229B-FL	Z4V3	4.09	4.3	4.52	20.0	22	2000	0.25	5.0	1.0
MMSZ5230B-FL	Z4V7	4.47	4.7	4.94	20.0	19	1900	0.25	5.0	2.0
MMSZ5231B-FL	Z5V1	4.85	5.1	5.36	20.0	17	1600	0.25	5.0	2.0
MMSZ5232B-FL	Z5V6	5.32	5.6	5.88	20.0	11	1600	0.25	5.0	3.0
MMSZ5233B-FL	Z6V0	5.70	6.0	6.30	20.0	7	1600	0.25	5.0	3.5
MMSZ5234B-FL	Z6V2	5.89	6.2	6.51	20.0	7	1000	0.25	5.0	4.0
MMSZ5235B-FL	Z6V8	6.46	6.8	7.14	20.0	5	750	0.25	3.0	5.0
MMSZ5236B-FL	Z7V5	7.13	7.5	7.88	20.0	6	500	0.25	3.0	6.0
MMSZ5237B-FL	Z8V2	7.79	8.2	8.61	20.0	8	500	0.25	3.0	6.5
MMSZ5238B-FL	Z8V7	8.27	8.7	9.14	20.0	8	600	0.25	3.0	6.5
MMSZ5239B-FL	Z9V1	8.65	9.1	9.56	20.0	10	600	0.25	3.0	7.0
MMSZ5240B-FL	Z10V	9.50	10	10.50	20.0	17	600	0.25	3.0	8.0
MMSZ5241B-FL	Z11V	10.45	11	11.55	20.0	22	600	0.25	2.0	8.4
MMSZ5242B-FL	Z12V	11.40	12	12.60	20.0	30	600	0.25	1.0	9.1
MMSZ5243B-FL	Z13V	12.35	13	13.65	9.5	13	600	0.25	0.5	9.9
MMSZ5244B-FL	Z14V	13.30	14	14.70	9.0	15	600	0.25	0.1	10
MMSZ5245B-FL	Z15V	14.25	15	15.75	8.5	16	600	0.25	0.1	11
MMSZ5246B-FL	Z16V	15.20	16	16.80	7.8	17	600	0.25	0.1	12
MMSZ5247B-FL	Z17V	16.15	17	17.85	7.4	19	600	0.25	0.1	13
MMSZ5248B-FL	Z18V	17.10	18	18.90	7.0	21	600	0.25	0.1	14
MMSZ5249B-FL	Z19V	18.05	19	19.95	6.6	23	600	0.25	0.1	14
MMSZ5250B-FL	Z20V	19.00	20	21.00	6.2	25	600	0.25	0.1	15
MMSZ5251B-FL	Z22V	20.90	22	23.10	5.6	29	600	0.25	0.1	17
MMSZ5252B-FL	Z24V	22.80	24	25.20	5.2	33	600	0.25	0.1	18
MMSZ5253B-FL	Z25V	23.75	25	26.25	5.0	35	600	0.25	0.1	19
MMSZ5254B-FL	Z27V	25.65	27	28.35	4.6	41	600	0.25	0.1	21
MMSZ5255B-FL	Z28V	26.60	28	29.40	4.5	44	600	0.25	0.1	21
MMSZ5256B-FL	Z30V	28.50	30	31.50	4.2	49	600	0.25	0.1	23
MMSZ5257B-FL	Z33V	31.35	33	34.65	3.8	58	700	0.25	0.1	25
MMSZ5258B-FL	Z36V	34.20	36	37.80	3.4	70	700	0.25	0.1	27
MMSZ5259B-FL	Z39V	37.05	39	40.95	3.2	80	800	0.25	0.1	30
MMSZ5260B-FL	Z43V	40.85	43	45.15	3.0	93	900	0.25	0.1	33
MMSZ5261B-FL	Z47V	44.65	47	49.35	2.7	105	1000	0.25	0.1	36
MMSZ5262B-FL	Z51V	48.45	51	53.55	2.5	125	1100	0.25	0.1	39
MMSZ5263B-FL	Z56V	53.20	56	58.80	2.2	150	1300	0.25	0.1	43
MMSZ5264B-FL	Z60V	57.00	60	63.00	2.1	170	1400	0.25	0.1	46
MMSZ5265B-FL	Z62V	58.90	62	65.10	2.0	185	1400	0.25	0.1	47
MMSZ5266B-FL	Z68V	64.60	68	71.40	1.8	230	1600	0.25	0.1	52
MMSZ5267B-FL	Z75V	71.25	75	75.75	1.7	270	1700	0.25	0.1	56

Notes:

1. The zener voltage (V_Z) is tested under pulse condition of 1ms.
2. The device numCers listed have a standard tolerance on the nominal zener voltage of $\pm 5\%$.
3. The zener impedance is derived from the 60-cycle ac voltage, which results when an ac current having an rms value equal to 10% of the dc zener current (I_{ZT} or I_{ZK}) is superimposed to I_{ZT} or I_{ZK} .



Rating and characteristic curves (MMSZ5221-FL THRU MMSZ5267-FL)

FIG. 1-POWER DISSIPATION VS. AMBIENT TEMP.

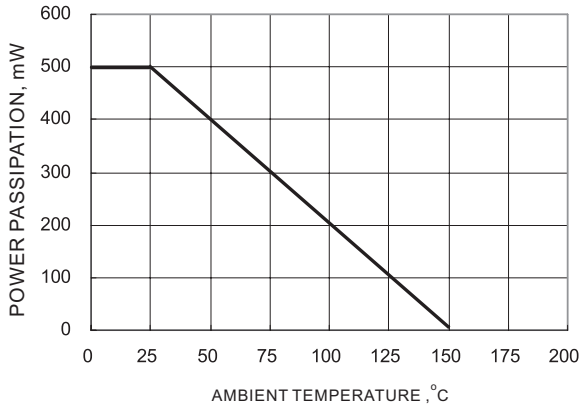

FIG. 2-EFFECT OF ZENER VOLTAGE ON ZENER IMPEDANCE

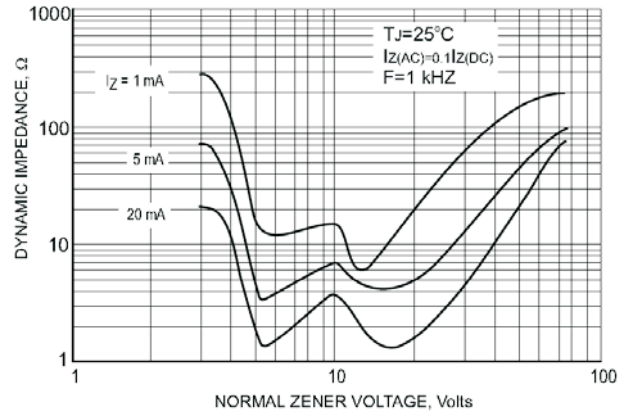

FIG. 3-TYPICAL FORWARD VOLTAGE

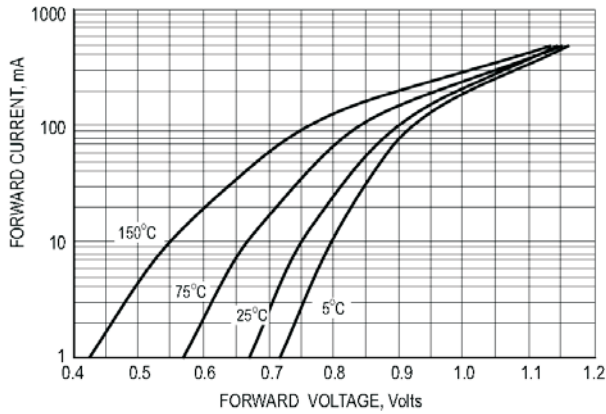

FIG. 4-TYPICAL CAPACITANCE

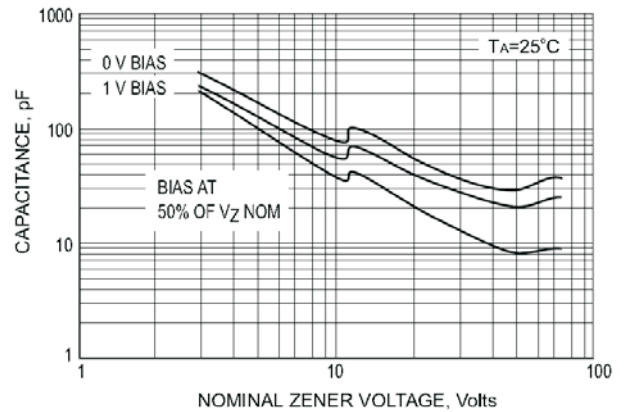

FIG. 5-ZENER BREAKDOWN CHARACTERISTICS

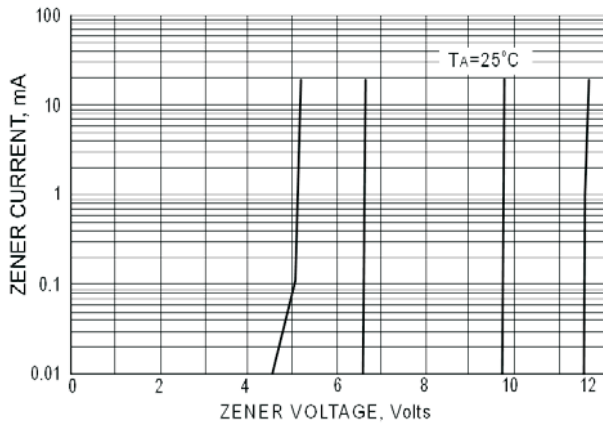
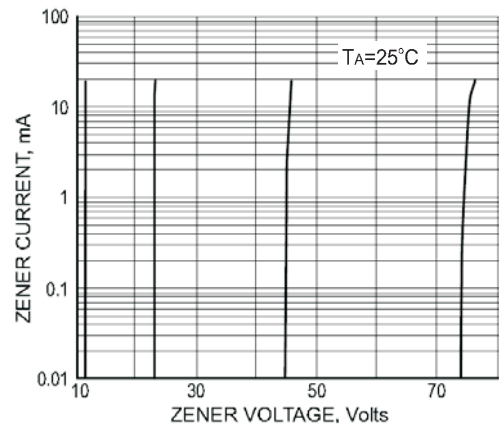
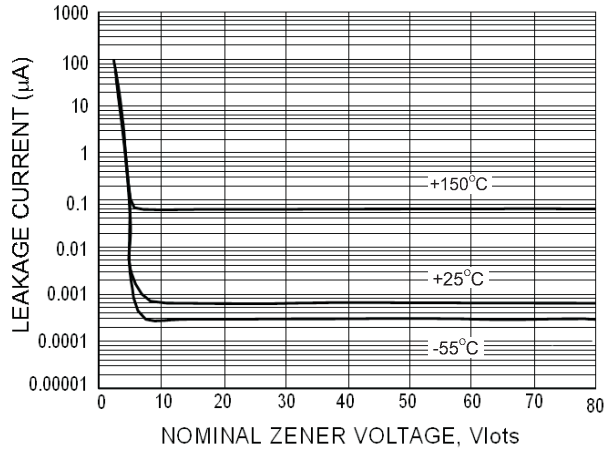

FIG. 6-ZENER BREAKDOWN CHARACTERISTICS





Rating and characteristic curves (MMSZ5221-FL THRU MMSZ5267-FL)

FIG. 7-TYPICAL LEAKGE CURRENT



MMSZ5221-FL THRU MMSZ5267-FL

Pinning information

Pin	Simplified outline	Symbol
Pin1 cathode Pin2 anode		

Suggested solder pad layout

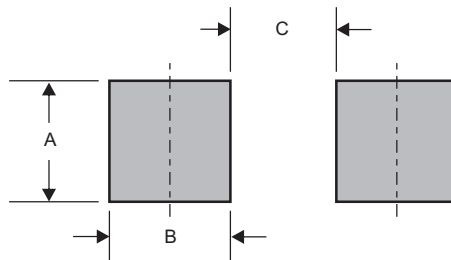

Dimensions in inches and (millimeters)

PACKAGE	A	B	C
SOD-123FL	0.028 (0.70)	0.028 (0.70)	0.091 (2.30)

MMSZ5221-FL THRU MMSZ5267-FL

Packing information

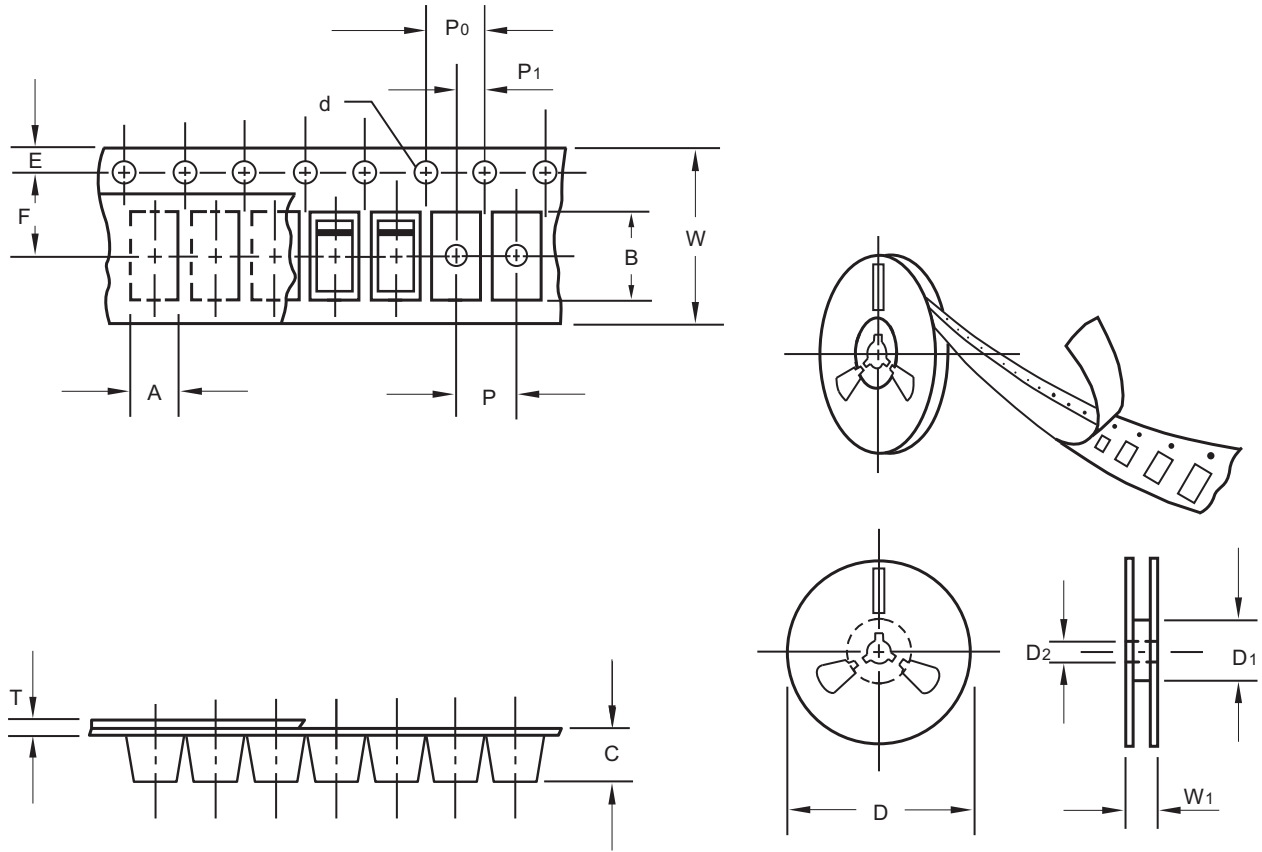

unit:mm

Item	Symbol	Tolerance	SOD-123FL
Carrier width	A	0.1	2.00
Carrier length	B	0.1	3.85
Carrier depth	C	0.1	1.10
Sprocket hole	d	0.1	1.50
13" Reel outside diameter	D	2.0	-
13" Reel inner diameter	D1	min	-
7" Reel outside diameter	D	2.0	178.00
7" Reel inner diameter	D1	min	62.00
Feed hole diameter	D2	0.5	13.00
Sprocket hole position	E	0.1	1.75
Punch hole position	F	0.1	3.50
Punch hole pitch	P	0.1	4.00
Sprocket hole pitch	P0	0.1	4.00
Embossment center	P1	0.1	2.00
Overall tape thickness	T	0.1	0.23
Tape width	W	0.3	8.00
Reel width	W1	1.0	11.40

Note: Devices are packed in accordance with EIA standard RS-481-A and specifications listed above.

MMSZ5221-FL THRU MMSZ5267-FL

Reel packing

PACKAGE	REEL SIZE	REEL (pcs)	COMPONENT SPACING (m/m)	BOX (pcs)	INNER BOX (m/m)	REEL DIA, (m/m)	CARTON SIZE (m/m)	CARTON (pcs)	APPROX. GROSS WEIGHT (kg)
SOD-123FL	7"	3,000	4.0	30,000	183*183*123	178	382*262*387	240,000	9.5

Suggested thermal profiles for soldering processes

- 1.Storage environment: Temperature=5°C~40°C Humidity=55%±25%
- 2.Reflow soldering of surface-mount devices

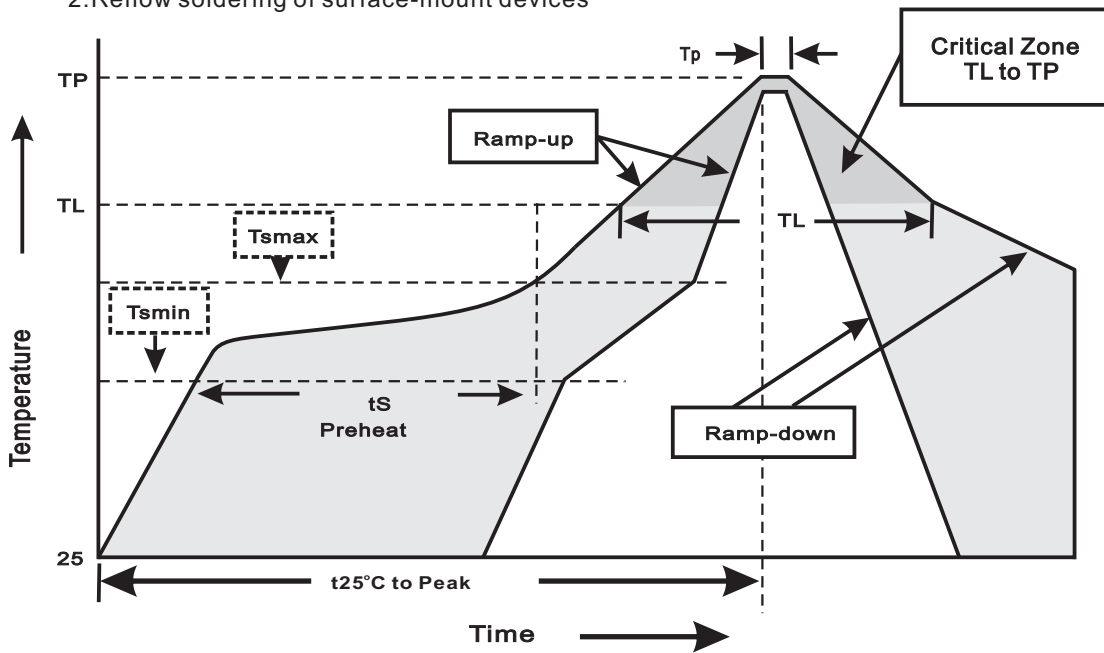

3.Reflow soldering

Profile Feature	Soldering Condition
Average ramp-up rate(TL to TP)	<3°C/sec
Preheat -Temperature Min(Tsmin) -Temperature Max(Tsmax) -Time(min to max)(ts)	150°C 200°C 60~120sec
Tsmax to TL -Ramp-upRate	<3°C/sec
Time maintained above: -Temperature(TL) -Time(tL)	217°C 60~260sec
Peak Temperature(TP)	255°C-0/+5°C
Time within 5°C of actual Peak Temperature(tp)	10~30sec
Ramp-down Rate	<6°C/sec
Time 25°C to Peak Temperature	<6minutes

MMSZ5221-FL THRU MMSZ5267-FL**High reliability test capabilities**

Item Test	Conditions	Reference
1. Solder Resistance	at 260±5°C for 10±2sec. immerse body into solder 1/16"±1/32"	MIL-STD-750D METHOD-2031
2. Solderability	at 245±5°C for 5 sec.	MIL-STD-202F METHOD-208
3. High Temperature Reverse Bias	$V_R=80\%$ rate at $T_J=150^\circ\text{C}$ for 168 hrs.	MIL-STD-750D METHOD-1038
4. Pressure Cooker	15P _{SI6} at $T_A=121^\circ\text{C}$ for 4 hrs.	JESD22-A102
5. Temperature Cycling	-55°C to +125°C dwelled for 30 min. and transferred for 5min. total 10 cycles.	MIL-STD-750D METHOD-1051
6. Thermal Shock	0°C for 5 min. rise to 100°C for 5 min. total 10 cycles.	MIL-STD-750D METHOD-1056
7. Humidity	at $T_A=85^\circ\text{C}$, RH=85% for 1000hrs.	MIL-STD-750D METHOD-1021
8. High Temperature Storage Life	at 175°C for 1000 hrs.	MIL-STD-750D METHOD-1031