

MOC205 , MOC206 , MOC207 , MOC208,  
MOC211 , MOC212 , MOC213 ,  
MOC215 , MOC216 , MOC217



**SMALL OUTLINE OPTICALLY  
COUPLED ISOLATOR  
TRANSISTOR OUTPUT**

**DESCRIPTION**

This series of optically coupled isolators consist of a Gallium Arsenide infrared emitting diode and NPN silicon photo transistor mounted in a standard 8 pin SOIC package, which makes them ideally suited for high density applications with limited space.

**FEATURES**

- Standard SOIC-8 Footprint with 0.05" Lead Spacing
- Specified min. and max. CTR at 10mA I<sub>F</sub> , 10V V<sub>CE</sub>  
MOC205, 40 - 80%  
MOC206, 63 - 125%  
MOC207, 100 - 200%  
MOC208, 160 - 320%
- Specified minimum CTR at 10mA I<sub>F</sub> , 10V V<sub>CE</sub>  
MOC211, 20%  
MOC212, 50%  
MOC213, 100%
- Specified minimum CTR at 1mA I<sub>F</sub> , 5V V<sub>CE</sub>  
MOC215, 20%  
MOC216, 50%  
MOC217, 100%
- Isolation Voltage , 2500 V<sub>RMS</sub>
- High BV<sub>CEO</sub> (70V min)
- All electrical parameters 100% tested
- Available in Tape and Reel - add suffix " T & R "
- Custom electrical selections available

**ABSOLUTE MAXIMUM RATINGS  
( 25°C unless otherwise noted)**

Storage Temperature \_\_\_\_\_ -55°C to +125°C  
Operating Temperature \_\_\_\_\_ -55°C to +100°C  
Lead Soldering Temperature \_\_\_\_\_ 260°C  
(single wave for 10 secs)  
Input to Output Isolation Voltage \_\_\_\_\_ 2500V<sub>RMS</sub>

**INPUT DIODE**

Forward Current \_\_\_\_\_ 60mA  
Reverse Voltage \_\_\_\_\_ 6V  
Peak Forward Current (tp ≤ 10µs) \_\_\_\_\_ 3A  
Power Dissipation \_\_\_\_\_ 100mW  
(derate linearly 1.33mW/°C above 25°C)  
Junction Temperature \_\_\_\_\_ 125°C

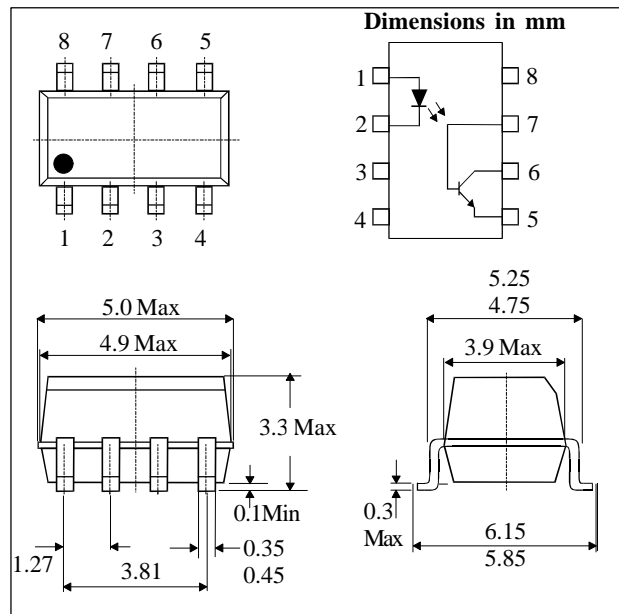

**APPLICATIONS**

- Computer terminals
- Industrial systems controllers
- Hybrid substrates that require high density mounting
- Signal transmission between systems of different potentials and impedances

**OUTPUT TRANSISTOR**

Collector-emitter Voltage BV<sub>CEO</sub> \_\_\_\_\_ 70V  
Emitter-collector Voltage BV<sub>ECO</sub> \_\_\_\_\_ 7V  
Collector-base Voltage BV<sub>CBO</sub> \_\_\_\_\_ 70V  
Collector Current \_\_\_\_\_ 50mA  
Collector Current \_\_\_\_\_ 100mA  
(pw ≤ 10ms , 50% duty ratio)  
Power Dissipation \_\_\_\_\_ 150mW  
(derate linearly 2.00mW/°C above 25°C)  
Junction Temperature \_\_\_\_\_ 125°C

**PACKAGE**

Total Power Dissipation \_\_\_\_\_ 250mW  
(derate linearly 3.3mW/°C above 25°C)

**ISOCOM COMPONENTS LTD**

Unit 25B, Park View Road West,  
Park View Industrial Estate, Brenda Road  
Hartlepool, Cleveland, TS25 1YD  
Tel: (01429) 863609 Fax: (01429) 863581

**ISOCOM INC**

1024 S. Greenville Ave, Suite 240,  
Allen, TX 75002 USA  
Tel: (214) 495-0755 Fax: (214) 495-0901  
e-mail info@isocom.com  
http://www.isocom.com

**ELECTRICAL CHARACTERISTICS (25°C unless otherwise noted)**

PARAMETER		MIN	TYP	MAX	UNITS	TEST CONDITIONS	
Input	Forward Voltage ( $V_F$ )		1.2	1.5	Volt	$I_F = 10\text{ mA}$ $V_R = 0, f = 1\text{ MHz}$ $V_R = 6\text{ V}$	
	Capacitance		50		pF		
	Reverse Current ( $I_R$ )			100	$\mu\text{A}$		
Output	Collector-emitter Voltage ( $BV_{CEO}$ )	70			Volt	$I_C = 100\text{ }\mu\text{A}$ $I_E = 100\text{ }\mu\text{A}$ $I_C = 100\text{ }\mu\text{A}$ $V_{CE} = 10\text{ V}$	
	Emitter-collector Voltage ( $BV_{ECO}$ )	7			Volt		
	Collector-base Voltage ( $BV_{CBO}$ )	70			Volt		
	Collector-emitter Dark Current ( $I_{CEO}$ )			50	nA		
Coupled	Current Transfer Ratio (CTR) MOC205	40		80	%	$I_F = 10\text{ mA}, V_{CE} = 10\text{ V}$	
	MOC206	63		125	%		
	MOC207	100		200	%		
	MOC208	160		320	%		
	MOC211	20			%		
	MOC212	50			%		
	MOC213	100			%		
	MOC205	13			%	$I_F = 1\text{ mA}, V_{CE} = 10\text{ V}$	
	MOC206	22			%		
	MOC207	34			%		
	MOC208	56			%	$I_F = 1\text{ mA}, V_{CE} = 5\text{ V}$	
	MOC215	20			%		
	MOC216	50			%		
	MOC217	100			%		
	Collector-emitter Saturation Voltage $V_{CE(SAT)}$ (MOC205 to MOC213)				0.4	Volt	$I_F = 10\text{ mA}, I_C = 2\text{ mA}$
	Collector-emitter Saturation Voltage $V_{CE(SAT)}$ (MOC215 to MOC217)				0.4	Volt	$I_F = 1\text{ mA}, I_C = 0.1\text{ mA}$
	Capacitance Input to Output ( $C_{ISO}$ )			0.3		pF	$f = 1\text{ MHz}$ (note 1)
Input to Output Isolation Resistance ( $R_{ISO}$ )			$10^{11}$		$\Omega$	$V_{IO} = 500\text{ V}$ (note 1)	
Input to Output Isolation Voltage ( $V_{ISO}$ )	2500				$V_{RMS}$	Note 1	
Output Turn on Time ( $t_{on}$ )			3.0		$\mu\text{s}$	$I_C = 2\text{ mA},$ $V_{CC} = 10\text{ V}, R_L = 100\Omega$	
Output Turn off Time ( $t_{off}$ )			3.0		$\mu\text{s}$		
Output Rise Time ( $t_r$ )			1.6		$\mu\text{s}$		
Output Fall Time ( $t_f$ )			2.2		$\mu\text{s}$		

Note 1. Measured with input leads shorted together and output leads shorted together.

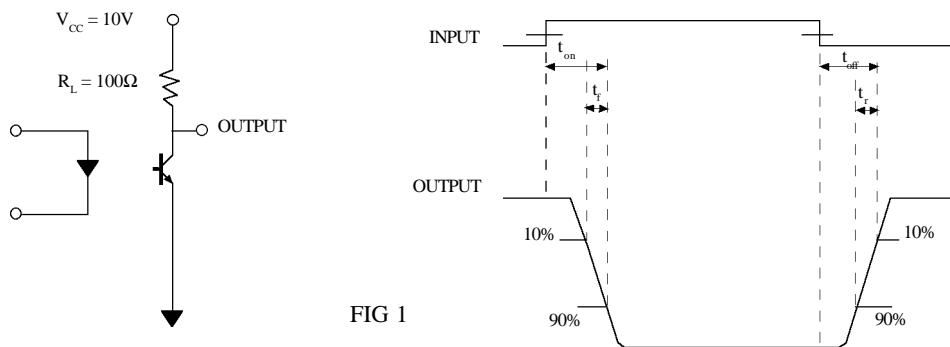
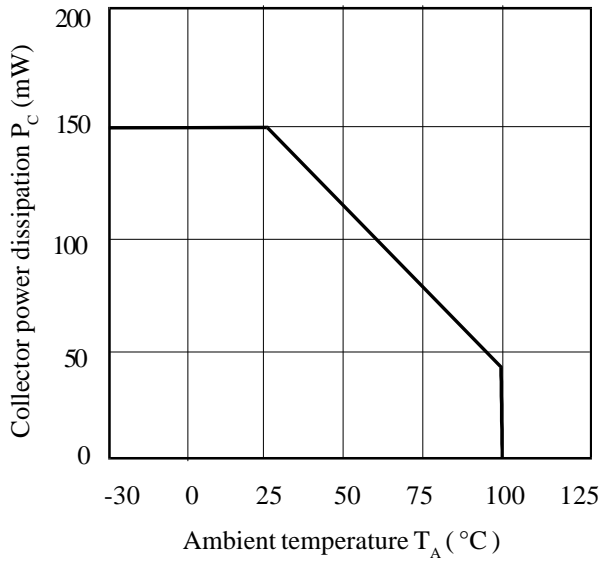
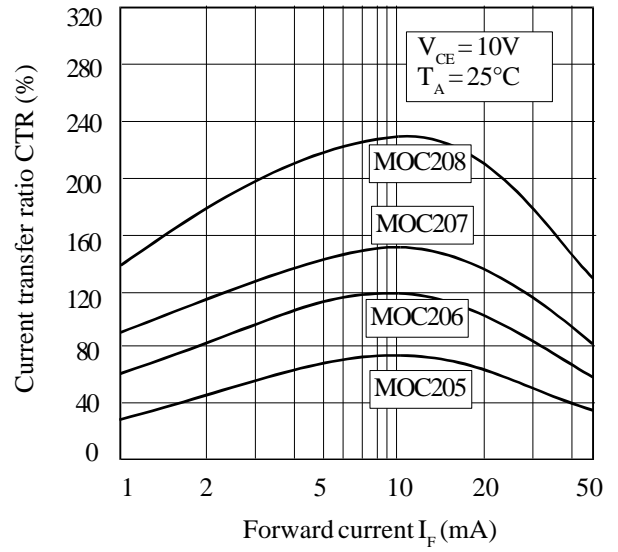

FIG 1

**Collector Power Dissipation vs. Ambient Temperature**



**Current Transfer Ratio vs. Forward Current**



**Forward Current vs. Ambient Temperature**

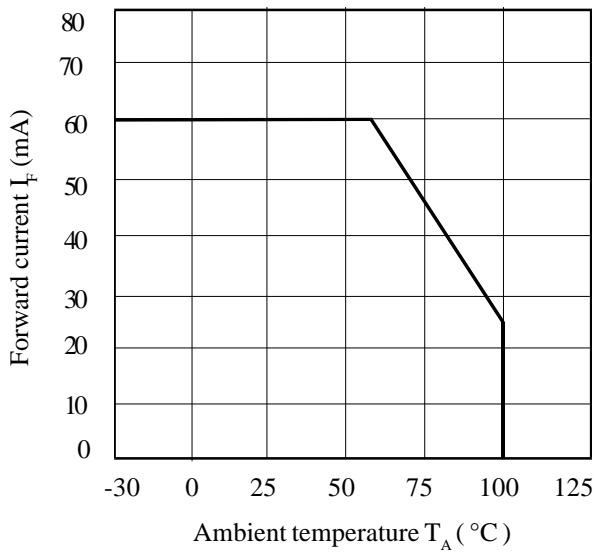

**Current Transfer Ratio vs. Forward Current**

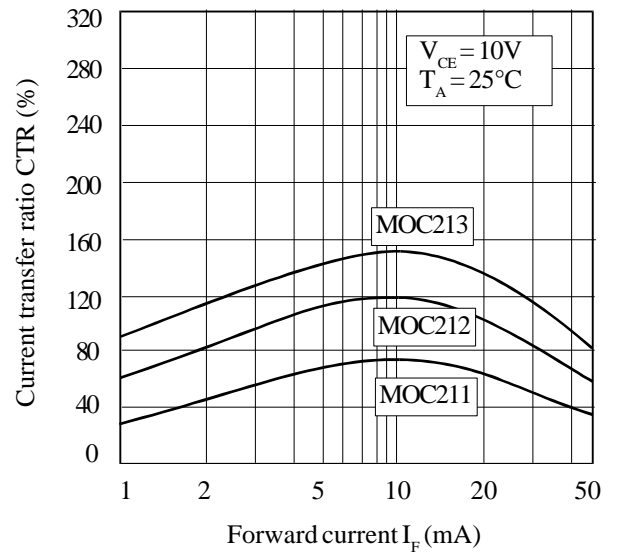

**Relative Current Transfer Ratio vs. Ambient Temperature**

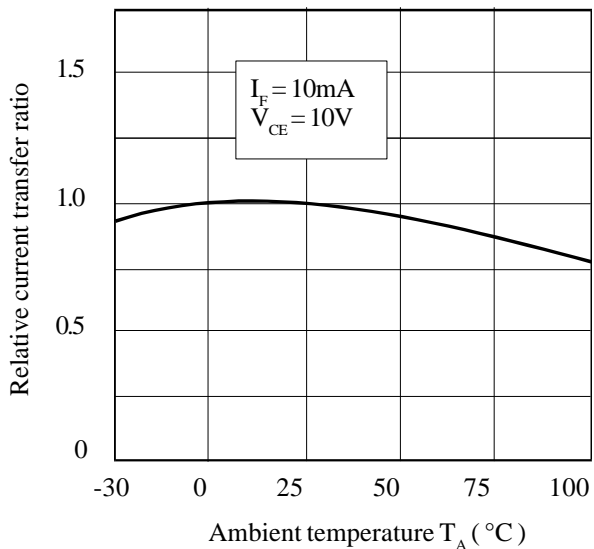

**Current Transfer Ratio vs. Forward Current**

