



Smoke Gas Sensor

(Model: MP-2)

Manual

Version: 1.2

Valid from: 2017-05-10

Zhengzhou Winsen Electronics Technology Co., Ltd

Statement

This manual copyright belongs to Zhengzhou Winsen Electronics Technology Co., LTD. Without the written permission, any part of this manual shall not be copied, translated, stored in database or retrieval system, also can't spread through electronic, copying, record ways.

Thanks for purchasing our product. In order to let customers use it better and reduce the faults caused by misuse, please read the manual carefully and operate it correctly in accordance with the instructions. If users disobey the terms or remove, disassemble, change the components inside of the sensor, we shall not be responsible for the loss.

The specific such as color, appearance, sizes &etc, please in kind prevail.

We are devoting ourselves to products development and technical innovation, so we reserve the right to improve the products without notice. Please confirm it is the valid version before using this manual. At the same time, users' comments on optimized using way are welcome.

Please keep the manual properly, in order to get help if you have questions during the usage in the future.

Zhengzhou Winsen Electronics Technology CO., LTD.

MP-2 Smoke Gas Sensor

MP-2 model with advanced planar construction is comprised of heater and metal oxide semiconductor material of subminiature Al_2O_3 ceramic plate, fetch out electrode down-lead, encapsulation in metal base and cap. When the target gas exists, the sensor's conductivity is more higher along with the gas concentration rising. Please use simple electrocircuit, convert change of conductivity to correspond output signal of gas concentration.

Features:

- * Good sensitivity to LPG, smoke in wide range
- * Small size
- * Long lifespan
- * Low cost
- * Simple circuit



Application

Domestic smoke leakage alarm, industrial smoke gas alarm and portable smoke detector.

Technical Parameters

Model			MP-2
Sensor Type			Flat Suraced Semiconductor
Standard Encapsulation			Metal Cap
Target Gas			C_3H_8 , smoke
Detection range			200~10000ppm C_3H_8
Standard Circuit Conditions	Loop Voltage	V_c	$\leq 10V$ DC
	Heater Voltage	V_H	$5V \pm 0.1V$ AC or DC
	Load Resistance	R_L	Adjustable
Sensor character under standard test conditions	Heater Resistance	R_H	$105\Omega \pm 10\Omega$ (room tem.)
	Heater consumption	P_H	$\leq 240mW$
	Sensitivity	S	$R_o(\text{in air})/R_s(\text{in } 2000\text{ppm } C_3H_8) \geq 3$
	Output voltage	V_s	$2.5V \sim 4.0V$ (in 2000ppm C_3H_8)
	Concentration Slope	α	$\leq 0.6(R_{3000\text{ppm}}/R_{500\text{ppm}} C_3H_8)$
Environment Conditions	Operation Temp.	T_{ao}	$-10^\circ C \sim 50^\circ C$
	Storage Temp.	T_{as}	$-20^\circ C \sim 70^\circ C$
	Relative Humidity	RH	Less than 95%RH
	O2 concentration	O_2	$21\% \pm 1\%$ (can't less than 18%) O2 concentration effects sensor's performance.
	Preheat time		Not less than 48 hours

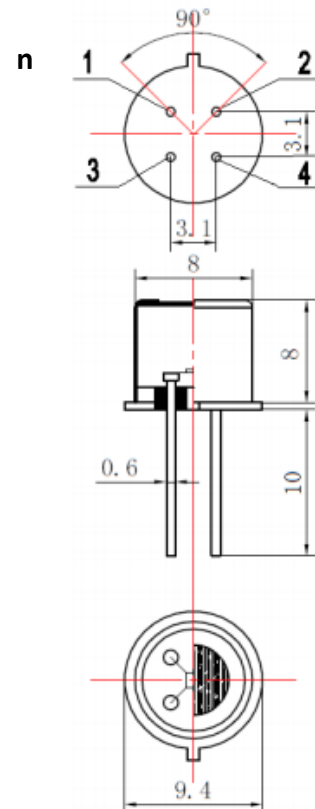

Fig1.MP-2 Configuration

Basic circuit

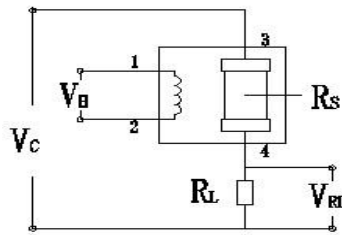

Fig2. Test circuit

This circuit shows the basic measuring circuit of sensor. Two voltage should be applied to this sensor, heating voltage (V_H) and test voltage (V_C). V_H is used for supplying a certain temperature which can be DC or AC. V_{RL} the voltage on the load resistance (R_L) which connects to the sensor in series. V_C is supply the test voltage for R_L and it must be DC.

Characterization

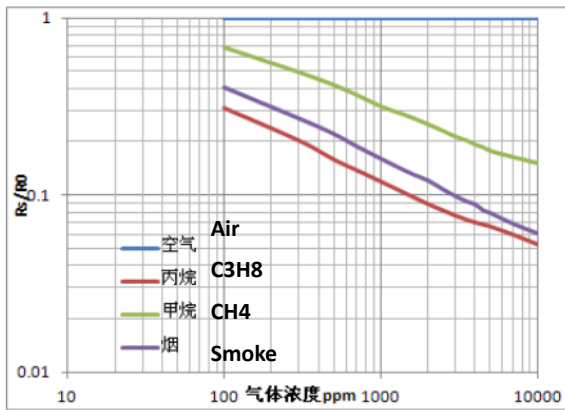

Fig3. Typical Sensitivity Curve

The ordinate is resistance ratio of the sensor (R_s/R_0), the abscissa is concentration of gases. R_s means resistance in target gas, R_0 means resistance of sensor in clean air. All tests are finished under standard test conditions.

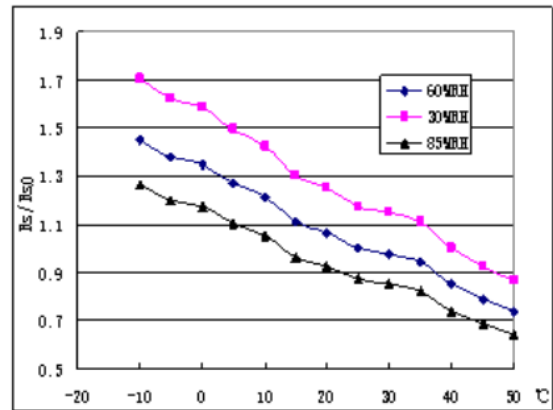

Fig4. Typical temperature/humidity characteristics

The ordinate is resistance ratio of the sensor (R_s/R_{s0}). R_s means resistance of sensor in 2000ppm C_3H_8 gas under different tem. and humidity. R_{s0} means resistance of the sensor in 2000ppm C_3H_8 gas under 20°C/65%RH.

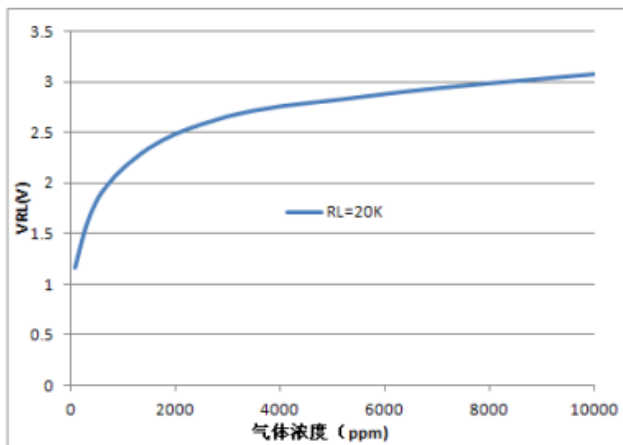

Fig5. Sensing Curve

It shows V_{RL} value when the sensor in C_3H_8 gas with different concentration. $R_L=20k\Omega$, All tests are finished under standard test conditions.

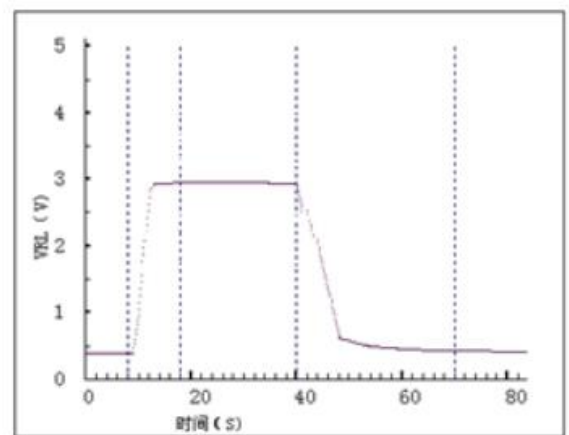

Fig6. Response and Recovery

It shows the V_{RL} changes when the sensor is put in target gas (2000ppm C_3H_8) and then is take from it to clean air.

Cautions

1 .Following conditions must be prohibited

1.1 Exposed to volatilizable organic silicon steam

Sensing material will lose sensitivity and never recover if the sensor absorbs organic silicon steam. Sensors must avoid exposing to silicon bond, fixture, silicon latex, putty or plastic contain silicon environment.

1.2 High Corrosive gas

If the sensors are exposed to high concentration corrosive gas (such as H_2S , SO_x , Cl_2 , HCl etc.), it will not only result in corrosion of sensors structure, also it cause sincere sensitivity attenuation.

1.3 Alkali, Alkali metals salt, halogen pollution

The sensors performance will be changed badly if sensors be sprayed polluted by alkali metals salt especially brine, or be exposed to halogen such as fluorine.

1.4 Touch water

Sensitivity of the sensors will be reduced when splattered or dipped in water.

1.5 Freezing

Do avoid icing on sensor's surface, otherwise sensing material will be broken and lost sensitivity.

1.6 Applied higher voltage

Applied voltage on sensor should not be higher than stipulated value, even if the sensor is not physically damaged or broken, it causes down-line or heater damaged, and bring on sensors' sensitivity characteristic changed badly.

1.7 Voltage on wrong pins

As Fig8, Pin 1&2 connects to heater circuit, Pin 3&4 connects to measuring circuit; Under the requested conditions, heating and measuring can use the same power circuit.

NOTE: the two pins near the protuberance mark is heating electrode.

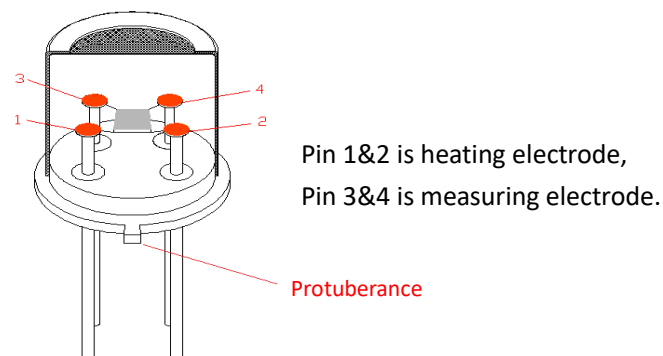

Fig6.Pin Schematic Diagram

2 .Following conditions should be avoided

2.1 Water Condensation

Indoor conditions, slight water condensation will influence sensors' performance lightly. However, if water condensation on sensors surface and keep a certain period, sensors' sensitive will be decreased.

2.2 Used in high gas concentration

No matter the sensor is electrified or not, if it is placed in high gas concentration for long time, sensors characteristic will be affected. If lighter gas sprays the sensor, it will cause extremely damage.

2.3 Long time storage

The sensors resistance will drift reversibly if it's stored for long time without electrify, this drift is related with storage conditions. Sensors should be stored in airproof bag without volatile silicon compound. For the sensors with long time storage but no electrify, they need long galvanical aging time for stability before using. The suggested aging time as follow:

Stable2.

Storage Time	Suggested aging time
Less than one month	Not less than 48 hours
1 ~ 6 months	Not less than 72 hours
More than six months	Not less than 168 hours

2.4 Long time exposed to adverse environment

No matter the sensors electrified or not, if exposed to adverse environment for long time, such as high humidity, high temperature, or high pollution etc., it will influence the sensors' performance badly.

2.5 Vibration

Continual vibration will result in sensors down-lead response then break. In transportation or assembling line, pneumatic screwdriver/ultrasonic welding machine can lead this vibration.

2.6 Concussion

If sensors meet strong concussion, it may lead its lead wire disconnected.

2.7 Usage Conditions

2.7.1 For sensor, handmade welding is optimal way. The welding conditions as follow:

- Soldering flux: Rosin soldering flux contains least chlorine
- homothermal soldering iron
- Temperature: 250°C
- Time: less than 3 seconds

2.7.2 If users choose wave-soldering, the following conditions should be obey:

- Soldering flux: Rosin soldering flux contains least chlorine
- Speed: 1-2 Meter/ Minute
- Warm-up temperature: 100±20°C
- Welding temperature: 250±10°C
- One time pass wave crest welding machine

If disobey the above using terms, sensors sensitivity will be reduced.

Zhengzhou Winsen Electronics Technology Co., Ltd

Add: No.299, Jinsuo Road, National Hi-Tech Zone,
Zhengzhou 450001 China

Tel: +86-371-67169097 / 67169670

Fax: +86-371-60932988

E-mail: sales@winsensor.com

Website: www.winsen-sensor.com