



Flammable Gas Sensor

(Model: MP-4)

Manual

Version: 1.4

Valid from: 2018-04-27

Zhengzhou Winsen Electronics Technology Co., Ltd

Statement

This manual copyright belongs to Zhengzhou Winsen Electronics Technology Co., LTD. Without the written permission, any part of this manual shall not be copied, translated, stored in database or retrieval system, also can't spread through electronic, copying, record ways.

Thanks for purchasing our product. In order to let customers use it better and reduce the faults caused by misuse, please read the manual carefully and operate it correctly in accordance with the instructions. If users disobey the terms or remove, disassemble, change the components inside of the sensor, we shall not be responsible for the loss.

The specific such as color, appearance, sizes &etc, please in kind prevail.

We are devoting ourselves to products development and technical innovation, so we reserve the right to improve the products without notice. Please confirm it is the valid version before using this manual. At the same time, users' comments on optimized using way are welcome.

Please keep the manual properly, in order to get help if you have questions during the usage in the future.

Zhengzhou Winsen Electronics Technology CO., LTD.

MP-4 Flammable Gas Sensor

MP-4 model with advanced planar construction is comprised of heater and metal oxide semiconductor material of subminiature Al₂O₃ ceramic plate, fetch out electrode down-lead, encapsulation in metal base and cap. When the target gas exists, the sensor's conductivity is more higher along with the gas concentration rising. Please use simple electrocircuit, convert change of conductivity to correspond output signal of gas concentration.

Features:

- * Lower consumption
- * Small size
- * Fast response and resume
- * Highest sensitivity
- * Excellent stability and long life
- * Easy circuit and big signal output
- * Excellent selectivity

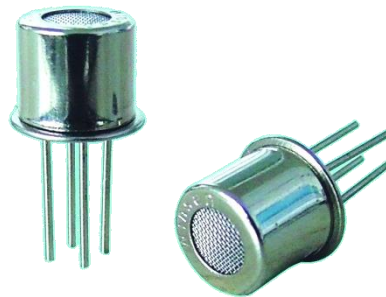

Application

It is widely used in domestic gas leakage alarm, industrial flammable gas alarm and portable gas detector.

Technical Parameters

Model		MP-4	
Sensor Type		Flat surfaced	
Standard Encapsulation		Metal cap	
Target Gas		CH ₄ , Nature gas, marsh gas	
Detection range		300~10000ppm (methane, natural gas)	
Standard Circuit Conditions	Loop Voltage	V _c	≤24V DC
	Heater Voltage	V _H	5V±0.1V AC or DC
	Load Resistance	R _L	Adjustable
Sensor character under standard test conditions	Heater Resistance	R _H	85Ω±15Ω (room temp.)
	Heater consumption	P _H	≤350mW
	Sensitive resistance	R _S	1KΩ ~ 20KΩ (in 5000ppm CH ₄)
	Sensitivity	S	R ₀ (in air)/R _S (5000ppm CH ₄)≥5
	Concentration Slope	α	≤0.6(R _{S5000ppm} /R _{S1000ppm} CH ₄)
Standard test conditions	Temp. Humidity	20°C±2°C; 55%±5%RH	
	Standard test circuit	V _c ::5V±0.1V; V _H : 5V±0.1V	
	Preheat time	Not less than 48 hours	
	O ₂ content	21% (not less than 18%) O ₂ concentration effects initial value, sensitivity and repeatability.	
Lifespan		10 years	

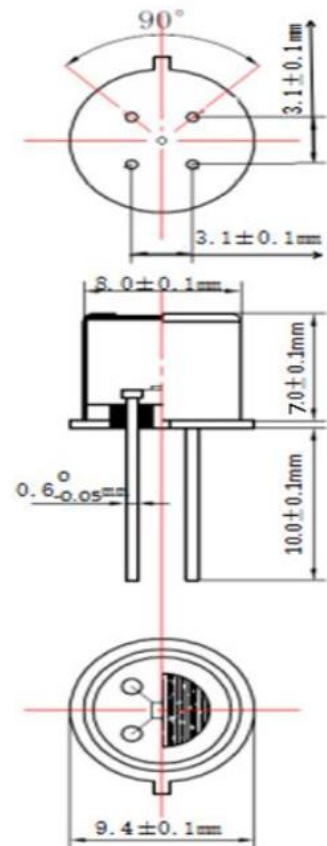

Fig1. Sensor structure

Basic circuit

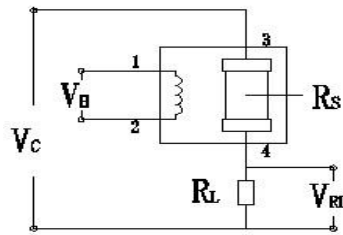

Fig2.Test circuit for MP-4

This circuit shows the basic measuring circuit of sensor. Two voltages should be applied to this sensor: heating voltage (V_H) and circuit voltage(V_c). V_H is used for supplying a certain temperature which can be DC or AC. V_{RL} is the voltage on the load resistance(R_L) which connects to the sensor in series. V_c is supply the test voltage for R_L and it must be DC.

Characterization

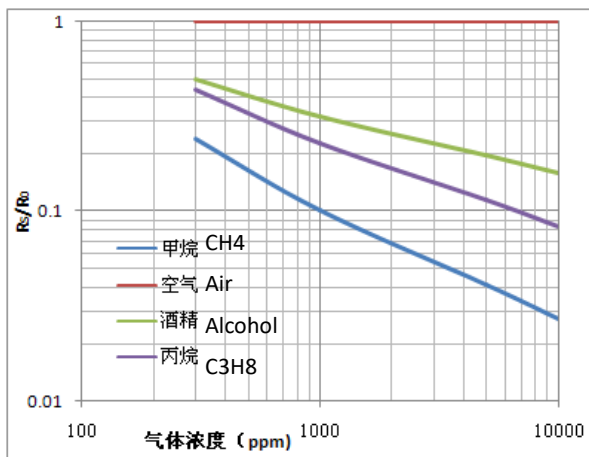

Fig3.Typical Sensitivity Curve

The ordinate is resistance ratio of the sensor (R_s/R_0), the abscissa is concentration of gases. R_s means resistance in target gas, R_0 means resistance of sensor in clean air. All tests are finished under standard test conditions.

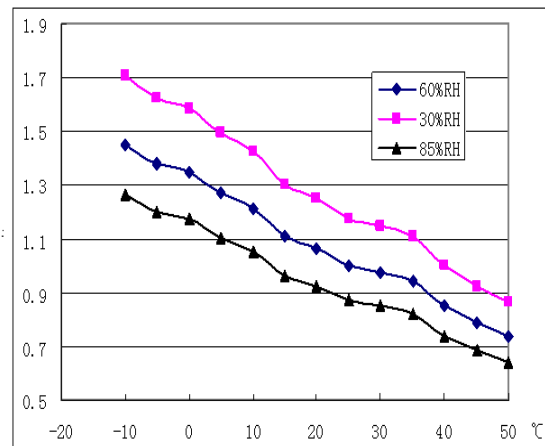

Fig4.Typical temperature/humidity characteristics

The ordinate is resistance ratio of the sensor (R_s/R_{so}). R_s means resistance of sensor in 5000ppm CH_4 gas under different tem. and humidity. R_{so} means resistance of the sensor in 5000ppm CH_4 gas under 20°C/65%RH.

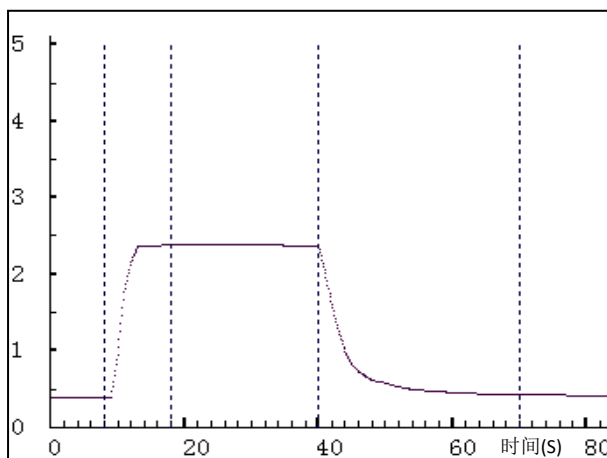

Fig5.Response and Resume curve

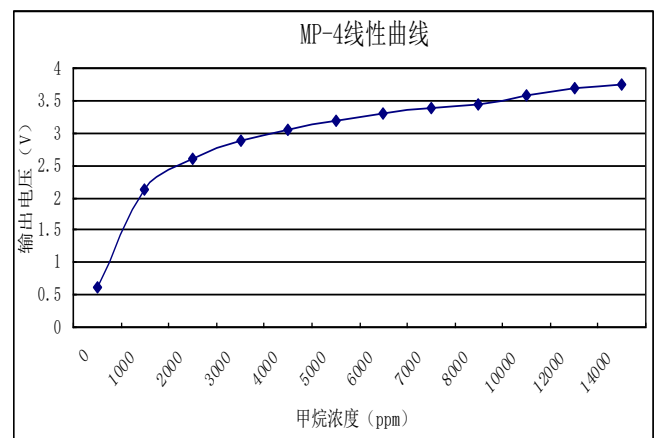
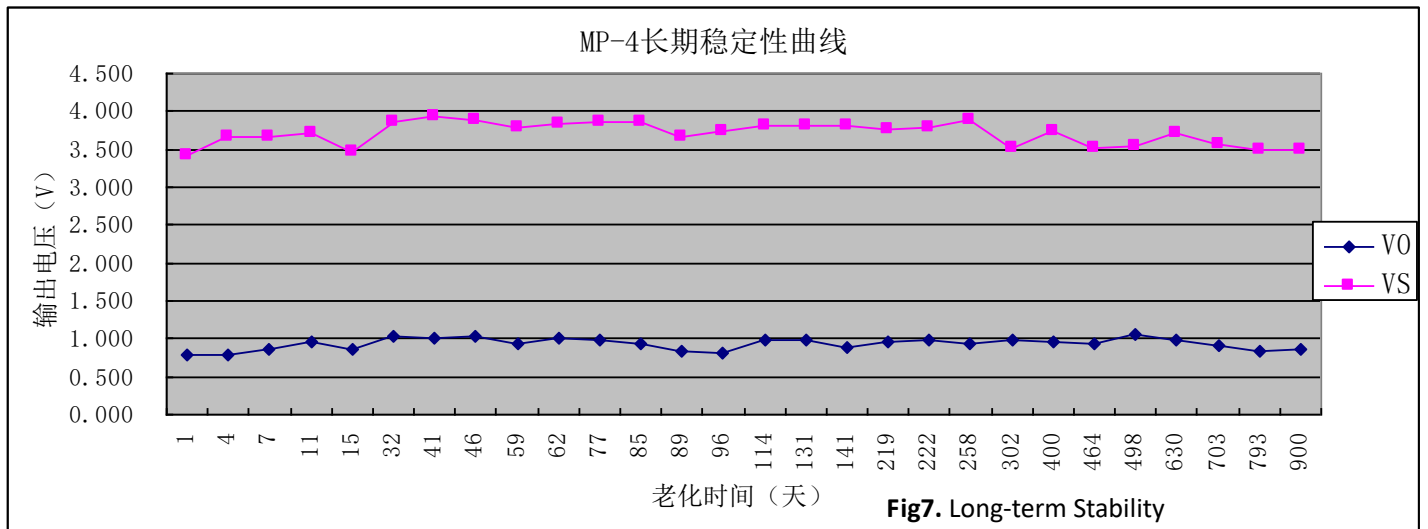

Fig6.Linear curve

Long-term Stability

NOTE: All the test is finished in standard test conditions, the abscissa is observing time and the ordinate is V_{RL} .

Cautions**1. Following conditions must be prohibited****1.1 Exposed to volatilizable organic silicon steam**

Sensing material will lose sensitivity and never recover if the sensor absorbs organic silicon steam. Sensors must avoid exposing to silicon bond, fixture, silicon latex, putty or plastic contain silicon environment.

1.2 High Corrosive gas

If the sensors are exposed to high concentration corrosive gas (such as H_2S , SO_x , Cl_2 , HCl etc.), it will not only result in corrosion of sensors structure, also it cause sincere sensitivity attenuation.

1.3 Alkali, Alkali metals salt, halogen pollution

The sensors performance will be changed badly if sensors be sprayed polluted by alkali metals salt especially brine, or be exposed to halogen such as fluorine.

1.4 Touch water

Sensitivity of the sensors will be reduced when splattered or dipped in water.

1.5 Freezing

Do avoid icing on sensor's surface, otherwise sensing material will be broken and lost sensitivity.

1.6 Applied higher voltage

Applied voltage on sensor should not be higher than stipulated value, even if the sensor is not physically damaged or broken, it causes down-line or heater damaged, and bring on sensors' sensitivity characteristic changed badly.

1.7 Voltage on wrong pins

As Fig8, Pin 1&2 connects to heater circuit, Pin 3&4 connects to measuring circuit; Under the requested conditions, heating and measuring can use the same power circuit.

NOTE: the two pins near the protuberance mark is heating electrode.

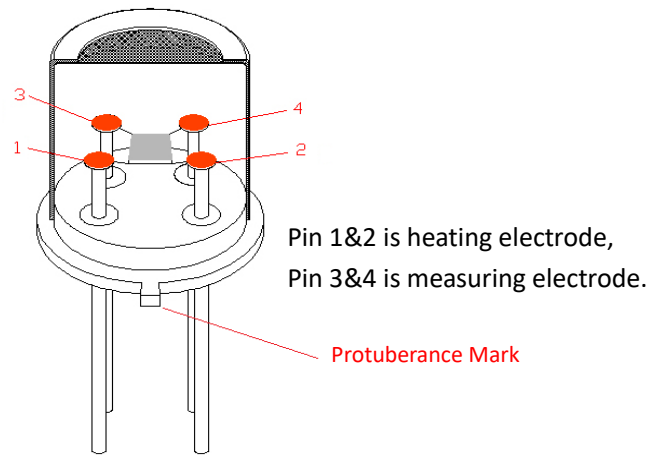

Fig8.Pin Schematic Diagram

2 .Following conditions should be avoided

2.1 Water Condensation

Indoor conditions, slight water condensation will influence sensors' performance lightly. However, if water condensation on sensors surface and keep a certain period, sensors' sensitive will be decreased.

2.2 Used in high gas concentration

No matter the sensor is electrified or not, if it is placed in high gas concentration for long time, sensors characteristic will be affected. If lighter gas sprays the sensor, it will cause extremely damage.

2.3 Long time storage

The sensors resistance will drift reversibly if it's stored for long time without electrify, this drift is related with storage conditions. Sensors should be stored in airproof bag without volatile silicon compound. For the sensors with long time storage but no electrify, they need long galvanical aging time for stability before using. The suggested aging time as follow:

Stable2.

Storage Time	Suggested aging time
Less than one month	No less than 48 hours
1 ~ 6 months	No less than 72 hours
More than six months	No less than 168 hours

2.4 Long time exposed to adverse environment

No matter the sensors electrified or not, if exposed to adverse environment for long time, such as high humidity, high temperature, or high pollution etc., it will influence the sensors' performance badly.

2.5 Vibration

Continual vibration will result in sensors down-lead response then break. In transportation or assembling line, pneumatic screwdriver/ultrasonic welding machine can lead this vibration.

2.6 Concussion

If sensors meet strong concussion, it may lead its lead wire disconnected.

2.7 Usage Conditions

2.7.1For sensor, handmade welding is optimal way. The welding conditions as follow:

- Soldering flux: Rosin soldering flux contains least chlorine
 - homothermal soldering iron
 - Temperature: 250°C
 - Time: less than 3 seconds
- 2.7.2 If users choose wave-soldering, the following conditions should be obey:
- Soldering flux: Rosin soldering flux contains least chlorine
 - Speed: 1-2 Meter/ Minute
 - Warm-up temperature: 100±20°C
 - Welding temperature: 250±10°C
 - One time pass wave crest welding machine

If disobey the above using terms, sensors sensitivity will be reduced.

Zhengzhou Winsen Electronics Technology Co., Ltd
Add: No.299, Jinsuo Road, National Hi-Tech Zone,
Zhengzhou 450001 China
Tel: +86-371-67169097 / 67169670
Fax: +86-371-60932988
E-mail: sales@winsensor.com
Website: www.winsen-sensor.com