

MPS-301A

Integrated, Absolute Pressure Sensor

Integrated, Absolute Pressure Sensor

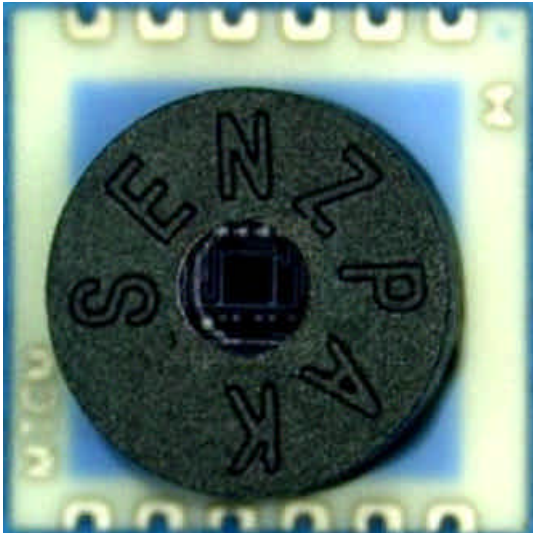

The MPS-301A series pressure sensor is a hybrid device containing an absolute piezoresistive pressure sensing element and an ASIC for signal conditioning. The sensor element is fabricated using bulk micromachining technology.

The ASIC includes temperature and nonlinearity corrections as well as offset and span calibration incorporating a 16 bit digital signal path.

The device is digitally calibrated and tested over temperature to ensure that the relevant accuracy and stability performance is met.

Output options include digital interfaces such as SPI and I²C as well as the traditional analogue output that can be interfaced to an external ADC.

Temperature readout is optionally available on digital SPI and I²C interface options.

FEATURES

- Very low cost
- Excellent repeatability
- 100% factory tested and calibrated
- Stable and reliable
- High volume manufacturing

THE MAIN FIELD OF APPLICATIONS

- ✓ Mobile altimeter/barometer
- ✓ Weather Forecast
- ✓ Wristwatch
- ✓ Air Balloon
- ✓ Blood Pressure Monitoring

MPS-301A

Integrated, Absolute Pressure Sensor

TECHNICAL DATA

Specification	Min.	Typ.	Max.	Unit
Operating Temperature	-20	-	85	°C
Storage Temperature	-30	-	85	°C
Proof Pressure	-	-	500	kPa
	-	-	5000	hPa
	-	-	75	psi
Supply Voltage*	2.7	2.8	3.0	V
	4.75	5.0	5.25	V

* Note: Both 3V and 5V versions are available. Product is calibrated and tested at 3V unless otherwise specified.

BASIC PERFORMANCE

Temperature= $22\pm 2^{\circ}\text{C}$, Relative humidity= $45\pm 5\%$

Specification	Min.	Typ.	Max.	Unit
Supply Current @ 3V	-	3	4	mA
Operating Temperature	-20	-	85	°C
Operating Pressure	30	-	110	kPaA
	300	-	1100	hPaA
	4.35	-	16	psiA
Warm Up Time	-	25	-	ms
Storage Temperature	-30	-	85	°C
Power Supply Capacitor*	100	220	470	nF

* Note: Power supply capacitor is highly recommended for noise reduction

PRODUCT OPTIONS

Option	Interface	Calibration Power Supply	Parameters available for readout
A	Analogue	3V	Pressure
A5	Analogue	5V	Pressure
I	Digital I ² C	3V	Pressure
I5	Digital I ² C	5V	Pressure
IT	Digital I ² C	3V	Pressure and Temperature
IT5	Digital I ² C	5V	Pressure and Temperature
S	Digital SPI	3V	Pressure
S5	Digital SPI	5V	Pressure
ST	Digital SPI	3V	Pressure and Temperature
ST5	Digital SPI	5V	Pressure and Temperature

MPS-301A

Integrated, Absolute Pressure Sensor

SPI / I²C OUTPUT – INTERFACE OPTIONS S & I

Specification	Min.	Typ.	Max.	Unit
SPI Clock Rate	-	-	1	MHz
Zero Pressure Output (Offset)	-	888	-	Hex
Full Scale Output	-	6666	-	Hex
Full Scale Span	-	5DDE	-	Hex
Accuracy (25 ±3°C & 75-110 kPa)	-	-	±0.3	%FS
Accuracy (0-85°C & 75-110 kPa)	-	-	±0.5	%FS
Pressure Resolution	-	0.02	-	kPa
Sensitivity	-	12C	-	Hex/kPa
	-	1E	-	Hex/hPa
	-	817	-	Hex/psi
Response Time	-	1	5	ms
Temperature Sensing Range	-20	-	85	°C
Temperature Output @ 0 °C		204E		Hex
Temperature Output @ 85 °C		7330		Hex
Temperature Sensing Accuracy*	-	-	±1	°C

* Temperature Sensing is only possible when using the Digital SPI/I²C interface.

ANALOG OUTPUT – INTERFACE OPTION A

Specification	Min.	Typ.	Max.	Unit
Zero Pressure Output (Offset)	0.178	0.200	0.222	V
Full Scale Output	2.378	2.400	2.422	V
Full Scale Span	-	2.20	-	V
Accuracy (25±3°C & 75-110 kPa)	-	-	± 0.3	%FS
Accuracy (0-85°C & 75-110 kPa)	-	-	± 0.5	%FS
Pressure Resolution	-	0.02	-	kPa
Sensitivity @ 3V	-	36.36	-	mV/kPa
	-	3.36	-	mV/hPa
	-	5.27	-	mV/psi

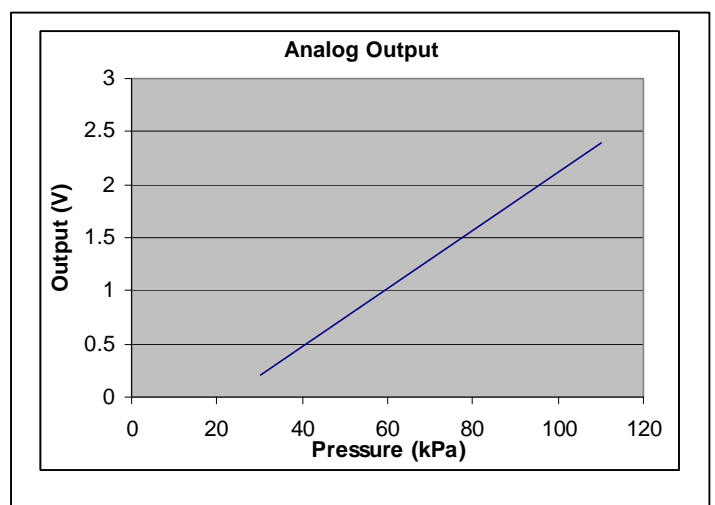

Typical sensor transfer function (V_{cc}=3V)

MPS-301A

Integrated, Absolute Pressure Sensor

ELECTRICAL & PIN LAYOUT

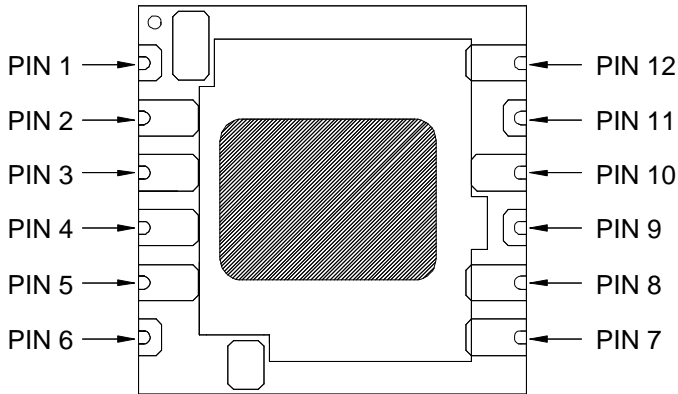

Pad	Symbol	Description
1	NC	No Connect
2	IO1	SPI data out (Interface Option S)
3	IO2	SPI chip select (Interface Option S)
4	SCL	I ² CLK & SPI Clock (Interface Options I & S)
5	SDA	Data I/O for I ² C & data in for SPI (Interface Options I & S)
6	NC	No Connect
7	Vdd	Power Supply Positive Connection
8	Vss	Power Supply Negative Connection
9	NC	No Connect
10	OUT	Analogue output
11	NC	No Connect
12	Vss	Power Supply Negative Connection

SPECIFICATION NOTES

- Operating and storage temperature to strictly not exceed stated values.
- Pressure unit conversion --- 1 atm=101.325 kPa=1013.25 hPa=14.504 psi.
- Operating pressure and temperature. The nominal pressure under which the device can be exposed under normal operating conditions. Unless explicitly stated, other specifications are rated over the operating pressure and temperature ranges.
- Proof pressure and temperature. The extremes of temperature and pressure that the device can withstand without performance degradation.
- Supply Voltage is the nominal operating voltage. The device output is ratio metric (scales with the supply) within the stated range.
- Stated Warm up time is a recommended time after power up before measurement stability is reached within the rated accuracy range.
- All outputs are measured with a nominal 4.7k load on the output pin, and with the power supply decoupled by 16uF electrolytic / 0.1uF ceramic capacitor pair, with an applied power supply within 5mV of the nominal value at temperature of T=25±5°C
- Accuracy represents the expected deviation of the sensor value from the ideal linear behavior over temperature and pressure, and includes thermal and pressure linearity and hysteresis effects over the life of the sensor. This is validated using accelerated aging techniques such as high temperature biased life, thermal cycling and thermal and pressure cycling tests.
- Offset stability represents the proportion of the deviation in offset (zero pressure output) at fixed temperature T=25±5°C, over the life of the sensor, and includes the effects of thermal and pressure hysteresis as well as other sources of drift.
- Device operating lifetime is verified using accelerated aging techniques.

MPS-301A

Integrated, Absolute Pressure Sensor

I²C INTERFACE DESCRIPTION (OPTION I)

For I²C communication only two pins are used namely SDA (Pin 5) and SCL (Pin 4). The sensor behaves as a slave in this communication.

The I²C protocol is defined as follows:

- i) Idle period : During inactivity the SDA and SCL are pulled to supply voltage Vdd
- ii) Start Condition: A high to low transition on SDA while SCL is high indicates a start condition. Every command has to be initiated by a start condition sent by the master. A master can always generate a start condition
- iii) Stop Condition: A low to high transition on SDA while SCL is high indicates a stop condition. A command has to be closed by a stop condition to start processing the command routine inside the Sensor

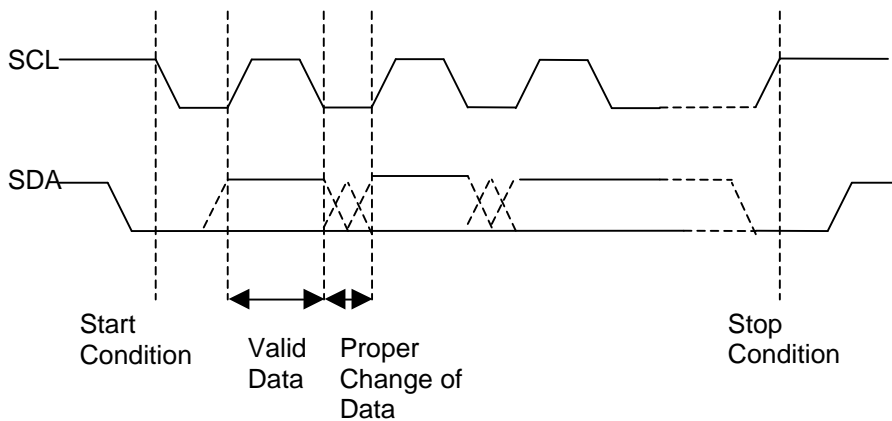

- iv) Valid Data: Data is transmitted in bytes (8 bits), MSB first. SDA transmits the data, while SCL clocks the data. Each byte transmitted is followed by an acknowledge bit. A bit is transferred by pulling SCL low, placing the data on SDA, then clocking SCL from high to low. Transmitted bits are valid after a start condition only if SDA keeps at constant level during the high period of SCL. The SDA level has to change only when clock signal SCL is low.
- v) Acknowledge Bit: Acknowledge after a transmitted byte is necessary. The transmitting device must generate an acknowledge related clock pulse. The receiver (slave or master) pulls down the SDA line during the acknowledge clock pulse. If no acknowledge is generated by the receiver the transmitting device will become inactive. A transmitting master can abort the transmission by generating a stop condition and may repeat the command.
- vi) Addressing: the slave address of the sensor is hard wired 7 bit address 0x78. This address cannot be changed. The master sends the address byte containing the 7 bit slave address followed by a read/write byte. '1' indicates a read and '0' indicates a write. The write operation is used exclusively by the manufacturer for calibration purposes and should not be used by the customer.
- vii) Read Operation: After power on the master should send a read request to the sensor according to the figure below. The master must generate the transmission clock on SCL and followed by the acknowledge bit for each data byte except the last which is sent by the sensor.

MPS-301A

Integrated, Absolute Pressure Sensor

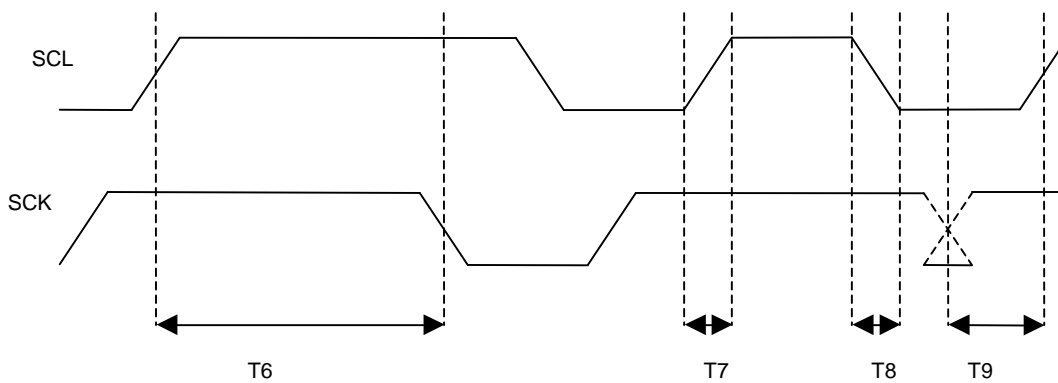
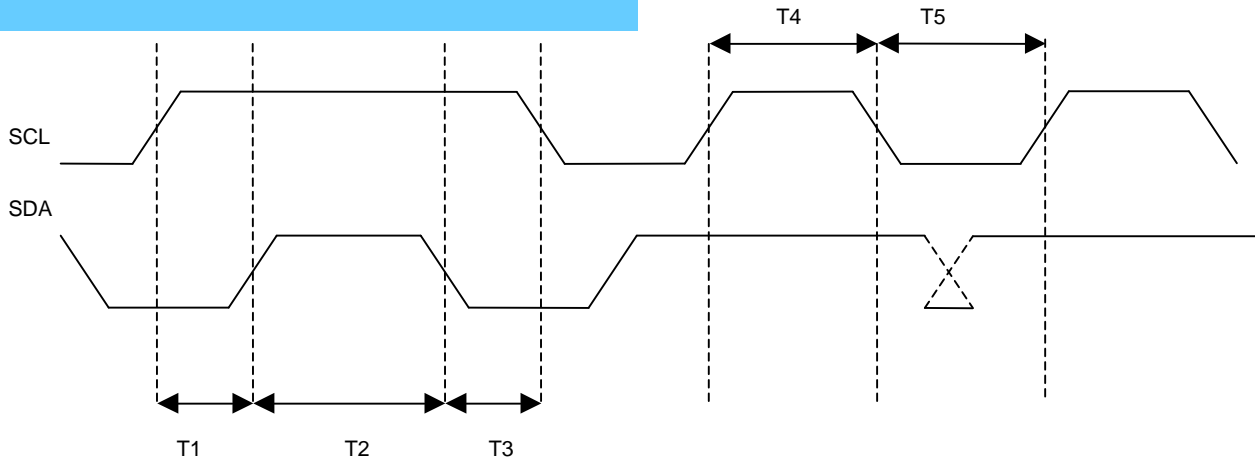

TIMING SPECIFICATIONS (I²C INTERFACE)

Parameter	Symbol	Min	Typ	Max	Unit
SCL Clock Frequency	f_{scl}	-	-	400	kHz
Bus Free time between start and stop condition	T2	1.3	-	-	μ s
Hold Time Start Condition	T3	0.6	-	-	μ s
High Period SCL/SDA	T4	1.3	-	-	μ s
Low Period SCL/SDA	T5	1.3	-	-	μ s
Setup Time Stop Condition	T1	0.6	-	-	μ s
Setup Time Repeated Start Condition	T6	0.6	-	-	μ s
Rise Time SCL/SDA	T7	0.3	-	-	μ s
Fall Time	T8	0.3	-	-	μ s
Data Setup Time	T9	0.1	-	-	μ s

MPS-301A

Integrated, Absolute Pressure Sensor

SPI INTERFACE DESCRIPTION – OPTION'S

SPI PIN SIGNALS

There are four I/O signals associated with SPI transfers: SCK (pin 4), MISO (pin 2), MOSI (used by the manufacturer for calibration purposes only) and SS (pin 3). SCK is an input pin for the clock signal from the master which synchronizes the data transfer between the master and slave devices. Slave devices ignore the SCK signal unless the SS pin is active low. Data is shifted on the rising edge of the SCK signal and is sampled on the opposite edge where the data is stable.

The MISO and MOSI data pins are used for transmitting and receiving serial data. For the slave the MOSI is the data input line and the MISO is the data output line. Once selected by the master the slave optionally drives data out its MOSI pin to the MISO of the master. The MOSI pin of the MTCM is solely for manufacturer's use and the customer is advised to disconnect this in their application.

The SS pin is used by the master to enable the SPI slave for a transfer. If the SS pin of a slave is inactive (High), the device ignores SCK clocks and keeps the MISO output pin in a high impedance state. The MBAP is always the slave and it is assumed in most cases the master is a microcontroller (MCU).

READING THE PRESSURE AND TEMPERATURE (OPTION ST)

To read the pressure/temperature value, power up the device and wait for > 25ms. After that read the data from the MISO pin. Five bytes have to be read out. MSB is transmitted first. The first byte is a dummy byte always set to 0xFF. For the second and fourth byte only the last seven bits should be considered with the eighth bit (the MSB) always set to binary 0. The third and fifth byte should be read as normal, MSB first. The pressure and temperature

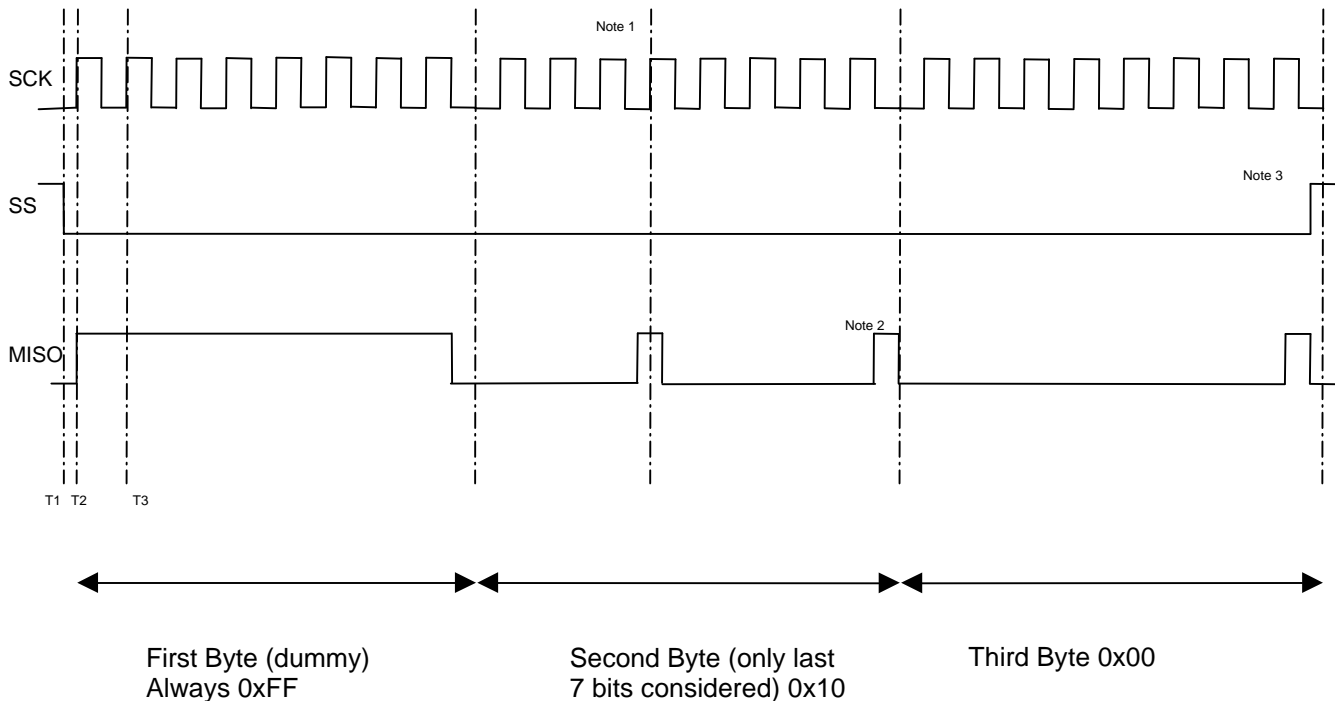

MPS-301A

Integrated, Absolute Pressure Sensor

Parameter	Description	Min	Typ	Max
T1-T2	SS delay before first SCK Pulse	1 μ s	-	-
T2-T3	SCK Clock Period	1 μ s	-	-

Note 1: Data must be sampled on the rising edge of the SCK

Note 2: There will be a dummy pulse starting from the middle of the 7th, 15th and 23rd SCK pulses lasting until after the next falling edge of the SCK. This pulse should be ignored.

Note 3: At the end of the transfer (24 clocks) the SS must be reasserted (brought high then low again) to begin another transfer.

Converting Digital Values to Engineering Units (SPI and I²C)

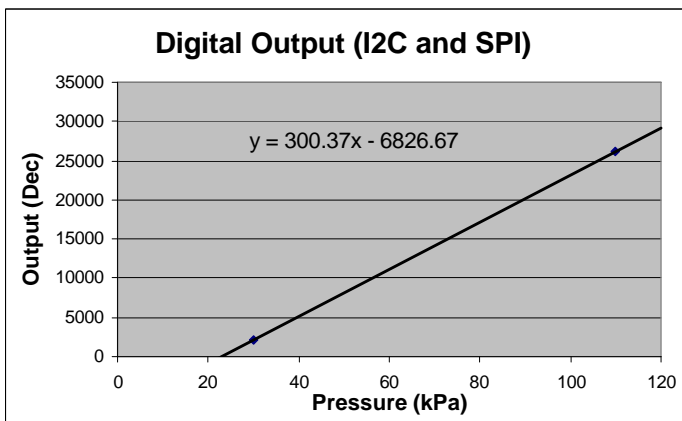

Conversion of Digital value to Engineering Units:

1. Digital value decimal
2. Add 6826.67
3. Divide by 300.37
4. result is in kPa

The chart at the left shows the transfer function used to calibrate the Digital output of the sensor pressure reading.

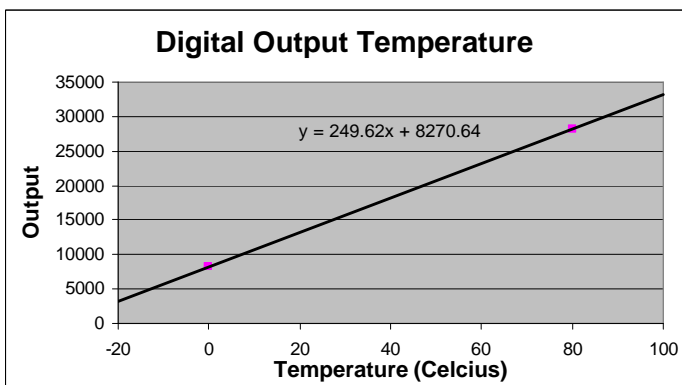

Conversion of Digital value to Engineering Units:

5. Digital value decimal
6. Subtract 8270.64
7. Divide by 249.62
8. result is in C

The chart at the left shows the transfer function used to calibrate the Digital output of the sensor temperature reading.

MPS-301A

Integrated, Absolute Pressure Sensor

MECHANICAL DIMENSIONS (9mm by 9mm, round cap)

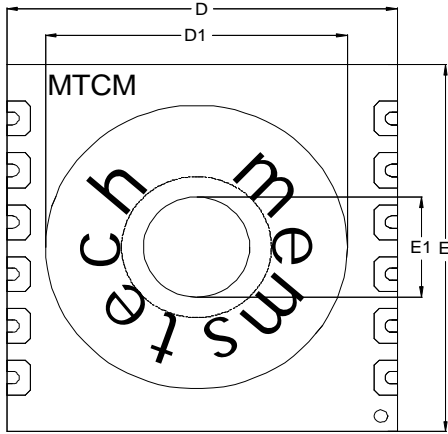

Top View

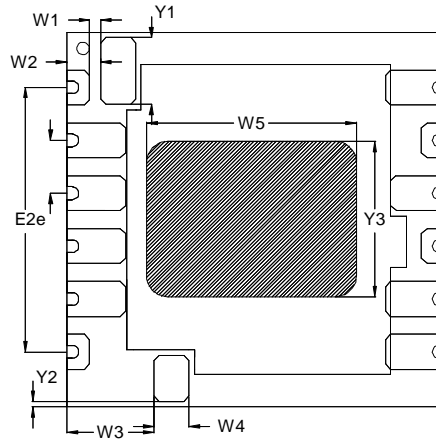

Bottom View

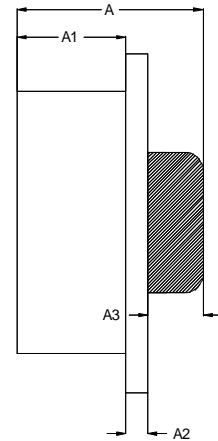

Side View

SYMBOL	e = 1.27mm BASIC			e = 0.050" BASIC		
	COMMON DIMENSION (mm)			COMMON DIMENSION (inch)		
	MINIMUM	NOMINAL	MAXIMUM	MINIMUM	NOMINAL	MAXIMUM
A	5.000	5.050	5.100	0.197	0.199	0.201
A1	2.900	2.950	3.000	0.114	0.116	0.118
A2	0.550	0.600	0.650	0.022	0.024	0.026
A3	1.450	1.500	1.550	0.057	0.059	0.061
D	8.950	9.000	9.050	0.352	0.354	0.356
D1	6.900	6.950	7.000	0.272	0.274	0.276
E	8.950	9.000	9.050	0.352	0.354	0.356
E1	2.400	2.450	2.500	0.094	0.096	0.098
E2	---	6.350	---	---	0.250	---
W1	0.219	0.269	0.319	0.008	0.011	0.013
W2	0.754	0.804	0.854	0.030	0.032	0.034
W3	2.029	2.079	2.129	0.080	0.082	0.084
W4	0.783	0.833	0.883	0.031	0.033	0.035
W5	4.952	5.002	5.052	0.195	0.197	0.199
Y1	1.543	1.593	1.643	0.061	0.063	0.065
Y2	0.077	0.127	0.177	0.003	0.005	0.007
Y3	3.680	3.730	3.780	0.145	0.147	0.149