

## TO-92 Plastic-Encapsulate Transistors

**MPSA06** TRANSISTOR (NPN)

**FEATURES**

- Power amplifier

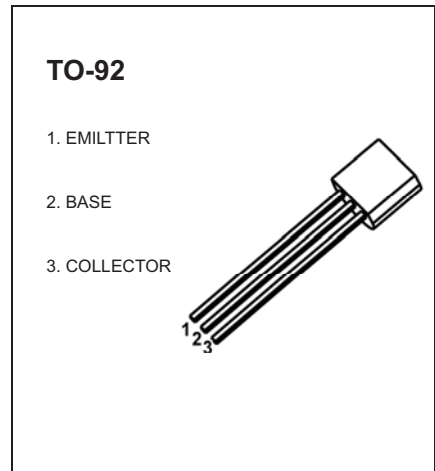

**MARKING**

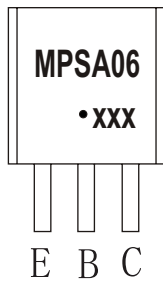

MPSA06=Device code  
 Solid dot=Green molding compound device,  
 if none,the normal device  
 XXX=Code

**Equivalent Circuit**

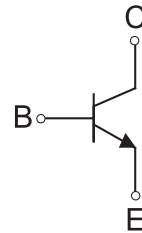

**ORDERING INFORMATION**

Part Number	Package	Packing Method	Pack Quantity
MPSA06	TO-92	Bulk	1000pcs/Bag
MPSA06-TA	TO-92	Tape	2000pcs/Box

**MAXIMUM RATINGS (T<sub>a</sub>=25°C unless otherwise noted)**

Symbol	Parameter	Value	Unit
V <sub>CB0</sub>	Collector-Base Voltage	80	V
V <sub>CE0</sub>	Collector-Emitter Voltage	80	V
V <sub>EBO</sub>	Emitter-Base Voltage	4	V
I <sub>c</sub>	Collector Current -Continuous	0.5	A
P <sub>D</sub>	Collector Power Dissipation	625	mW
R <sub>θJA</sub>	Thermal Resistance from Junction to Ambient	200	°C /W
T <sub>j</sub>	Junction Temperature	150	°C
T <sub>stg</sub>	Storage Temperature	-55~+150	°C

## ELECTRICAL CHARACTERISTICS

$T_a=25^\circ\text{C}$  unless otherwise specified

Parameter	Symbol	Test conditions	Min	Max	Unit
Collector-base breakdown voltage	$V_{(BR)CBO}$	$I_C=100\mu\text{A}, I_E=0$	80		V
Collector-emitter breakdown voltage	$V_{(BR)CEO}$	$I_C=1\text{mA}, I_B=0$	80		V
Emitter-base breakdown voltage	$V_{(BR)EBO}$	$I_E=100\mu\text{A}, I_C=0$	4		V
Collector cut-off current	$I_{CBO}$	$V_{CB}=80\text{V}, I_E=0$		0.1	$\mu\text{A}$
Collector cut-off current	$I_{CEO}$	$V_{CE}=60\text{V}, I_B=0$		0.1	$\mu\text{A}$
Emitter cut-off current	$I_{EBO}$	$V_{EB}=3\text{V}, I_C=0$		0.1	$\mu\text{A}$
DC current gain	$h_{FE1}$	$V_{CE}=1\text{V}, I_C=100\text{mA}$	100	400	
	$h_{FE2}$	$V_{CE}=1\text{V}, I_C=10\text{mA}$	100		
Collector-emitter saturation voltage	$V_{CE(sat)}$	$I_C=100\text{mA}, I_B=10\text{mA}$		0.25	V
Base-emitter saturation voltage	$V_{BE(sat)}$	$I_C=100\text{mA}, I_B=10\text{mA}$		1.2	V
Transition frequency	$f_T$	$V_{CE}=2\text{V}, I_C=10\text{mA}$ $f=100\text{MHz}$	100		MHz

# Typical Characteristics

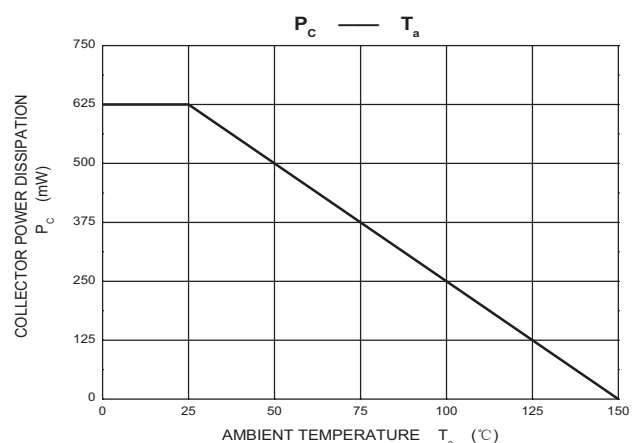
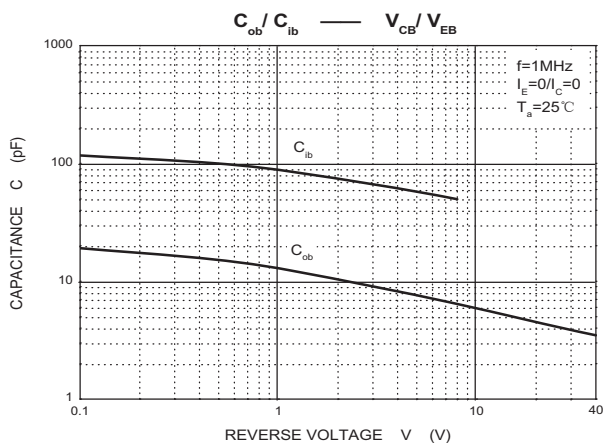
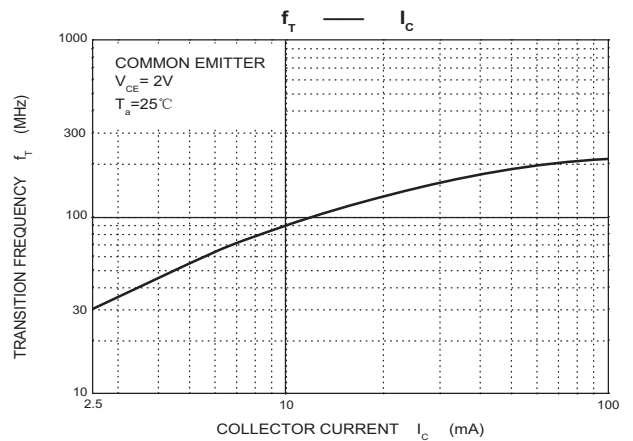
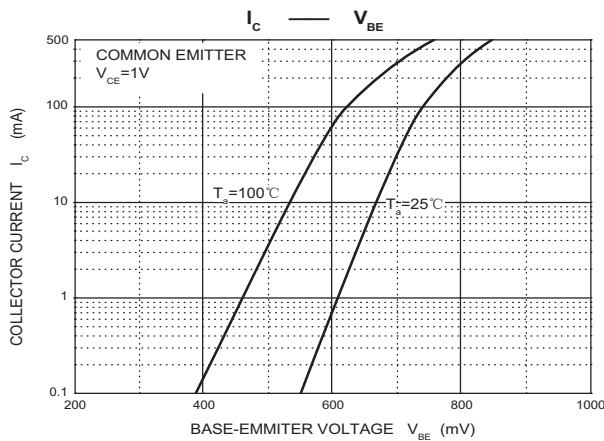
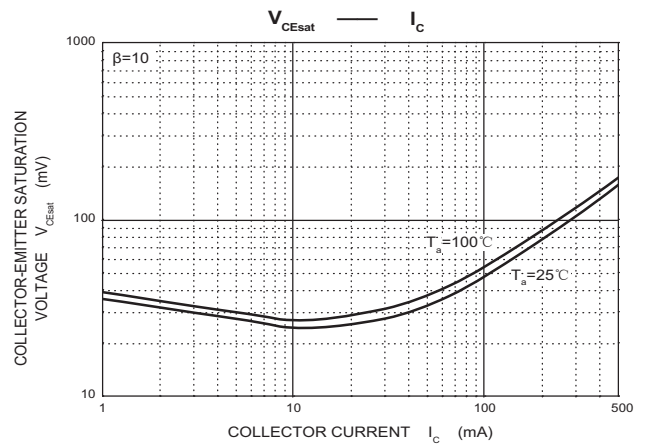
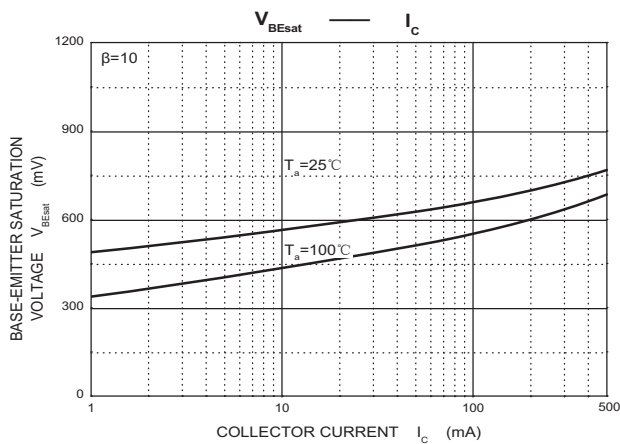
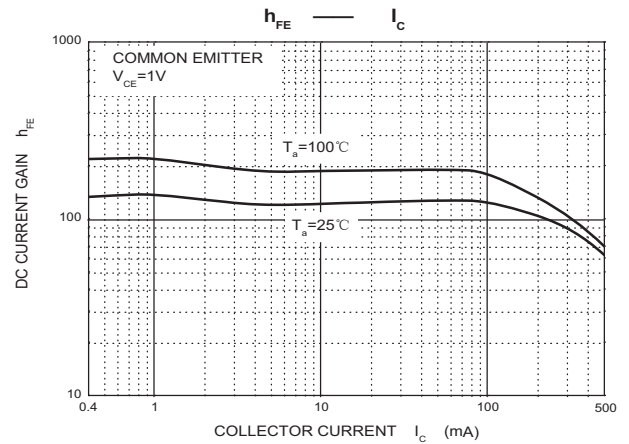
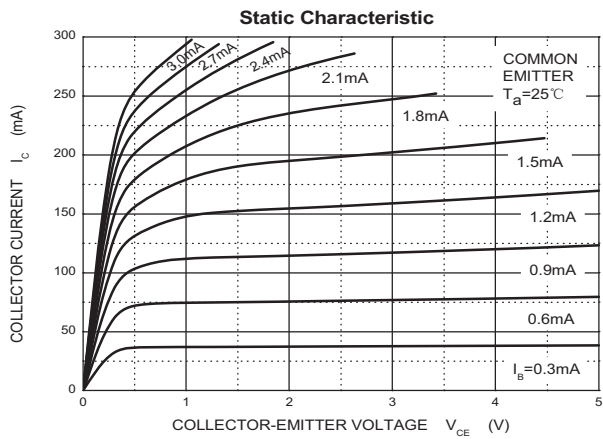

## TO-92 Package Outline Dimensions

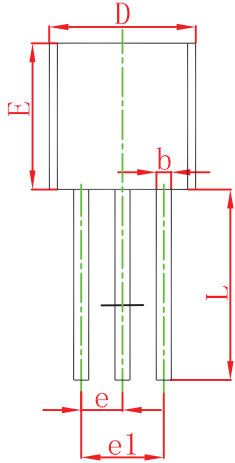
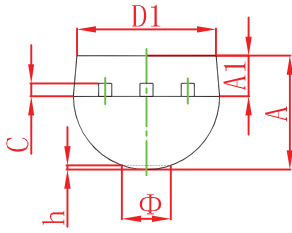

Symbol	Dimensions In Millimeters		Dimensions In Inches	
	Min	Max	Min	Max
A	3.300	3.700	0.130	0.146
A1	1.100	1.400	0.043	0.055
b	0.380	0.550	0.015	0.022
c	0.360	0.510	0.014	0.020
D	4.300	4.700	0.169	0.185
D1	3.430		0.135	
E	4.300	4.700	0.169	0.185
e	1.270 TYP		0.050 TYP	
e1	2.440	2.640	0.096	0.104
L	14.100	14.500	0.555	0.571
Φ		1.600		0.063
h	0.000	0.380	0.000	0.015

## TO-92 Suggested Pad Layout

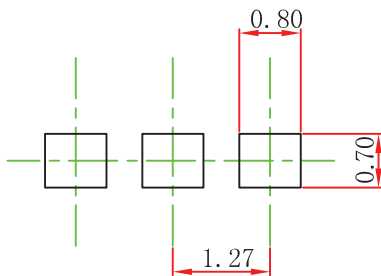

### Note:

1. Controlling dimension: in millimeters.
2. General tolerance:  $\pm 0.05\text{mm}$ .
3. The pad layout is for reference purposes only.

### NOTICE

JCET reserve the right to make modifications, enhancements, improvements, corrections or other changes without further notice to any product herein. JCET does not assume any liability arising out of the application or use of any product described herein.

TO-92 PACKAGE TAPEING DIMENSION

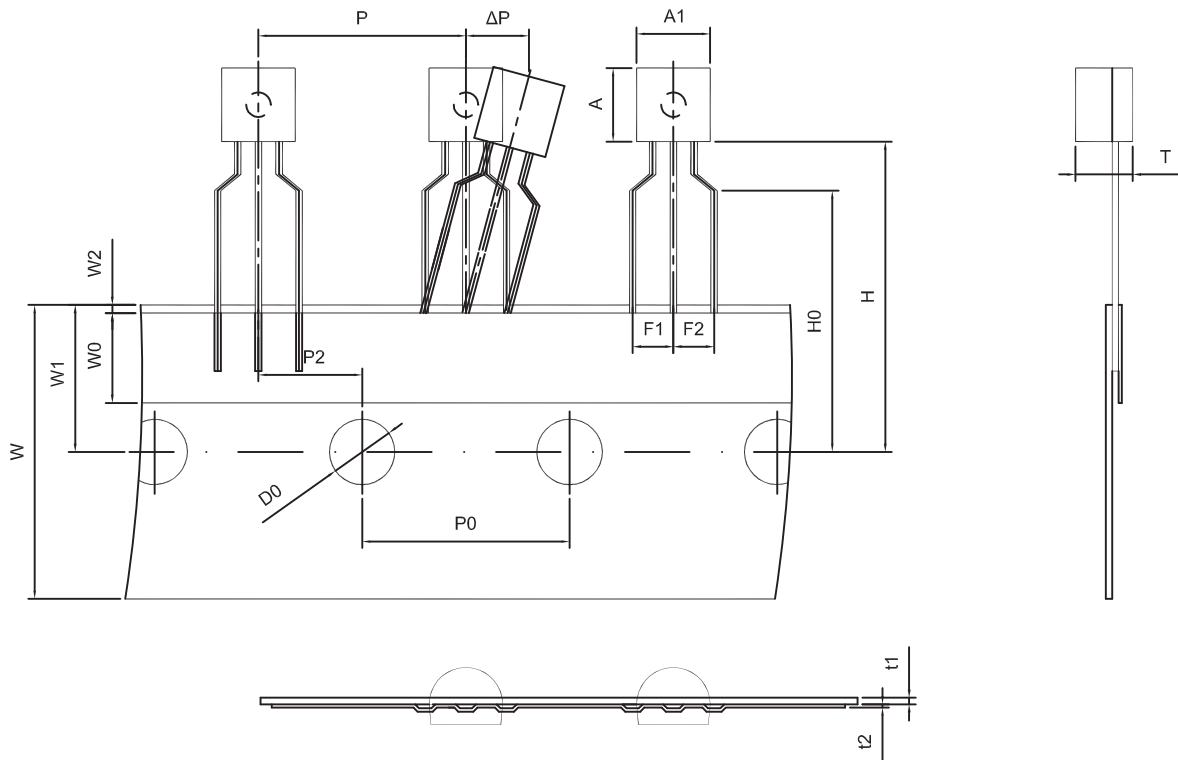

Dimensions are in millimeter								
A1	A	T	P	P0	P2	F1	F2	W
4.5	4.5	3.5	12.7	12.7	6.35	2.5	2.5	18.0
W0	W1	W2	H	H0	D0	t1	t2	ΔP
6.0	9.0	1.0 MAX.	19.0	16.0	4.0	0.4	0.2	0

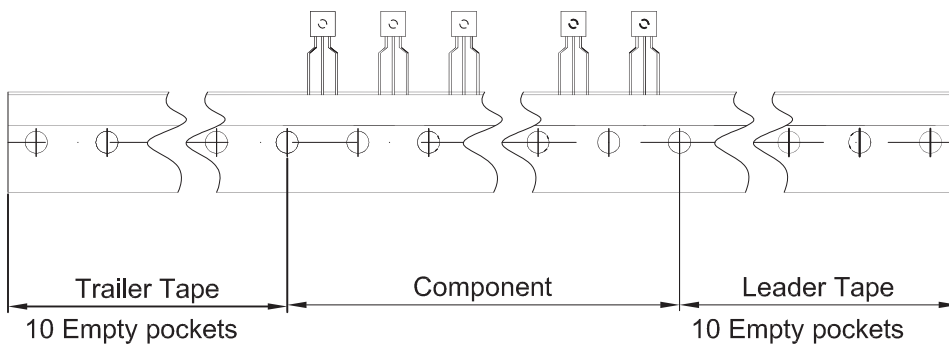

Package	Box	Box Size(mm)	Carton	Carton Size(mm)
TO-92	2000 pcs	333×162×43	20,000 pcs	350×340×250