

PNP Silicon High-Voltage Transistors

MPSA 92
MPSA 93

- High breakdown voltage
- Low collector-emitter saturation voltage
- Complementary types: MPSA 42
MPSA 43 (NPN)

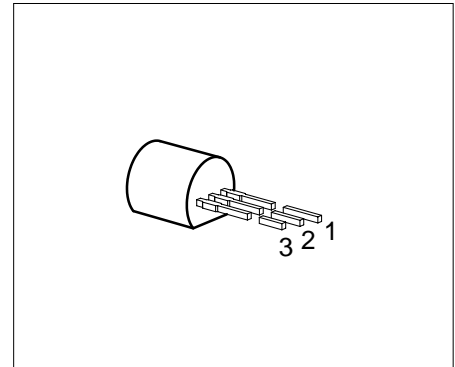

Type	Marking	Ordering Code	Pin Configuration			Package ¹⁾
			1	2	3	
MPSA 92	MPSA 92	Q68000-A5906	E	B	C	TO-92
MPSA 93	MPSA 93	Q68000-A4810				

Maximum Ratings

Parameter	Symbol	Values		Unit
		MPSA 92	MPSA 93	
Collector-emitter voltage	V_{CE0}	300	200	V
Collector-base voltage	V_{CB0}	300	200	
Emitter-base voltage	V_{EB0}	5		
Collector current	I_C	500		mA
Base current	I_B	100		
Total power dissipation, $T_C = 66\text{ °C}$ ²⁾	P_{tot}	625		mW
Junction temperature	T_j	150		°C
Storage temperature range	T_{stg}	- 65 ... + 150		

Thermal Resistance

Junction - ambient	$R_{th JA}$	≤ 200	K/W
Junction - case ²⁾	$R_{th JC}$	≤ 135	

¹⁾ For detailed information see chapter Package Outlines.

²⁾ Mounted on Al-heat sink 15 mm × 25 mm × 0.5 mm.

Electrical Characteristics

at $T_A = 25\text{ °C}$, unless otherwise specified.

Parameter	Symbol	Limit Values			Unit	
		min.	typ.	max.		
DC Characteristics						
Collector-emitter breakdown voltage $I_C = 1\text{ mA}, I_B = 0$	$V_{(BR)CE0}$	300	–	–	V	
MPSA 92						
MPSA 93		200	–	–		
Collector-base breakdown voltage $I_C = 100\text{ }\mu\text{A}, I_B = 0$	$V_{(BR)CB0}$	300	–	–		
MPSA 92						
MPSA 93		200	–	–		
Emitter-base breakdown voltage $I_E = 100\text{ }\mu\text{A}, I_B = 0$	$V_{(BR)EB0}$	5	–	–		
Collector-base cutoff current $V_{CB} = 200\text{ V}$	I_{CB0}	–	–	100	nA	
MPSA 92						
$V_{CB} = 160\text{ V}$		MPSA 93	–	–	100	nA
MPSA 93						
$V_{CB} = 200\text{ V}, T_A = 150\text{ °C}$	MPSA 92	–	–	20	μA	
$V_{CB} = 160\text{ V}, T_A = 150\text{ °C}$	MPSA 93	–	–	20	μA	
Emitter-base cutoff current $V_{BE} = 3\text{ V}, I_C = 0$	I_{CER}	–	–	100	nA	
DC current gain ¹⁾ $I_C = 1\text{ mA}, V_{CE} = 10\text{ V}$	h_{FE}	25	–	–	–	
$I_C = 10\text{ mA}, V_{CE} = 10\text{ V}$		40	–	–		
$I_C = 30\text{ mA}, V_{CE} = 10\text{ V}$		25	–	–		
Collector-emitter saturation voltage ¹⁾ $I_C = 20\text{ mA}, I_C = 2\text{ mA}$	V_{CEsat}	–	–	0.5	V	
MPSA 92						
MPSA 93		–	–	0.4		
Base-emitter saturation voltage ¹⁾ $I_C = 20\text{ mA}, I_B = 2\text{ mA}$	V_{BEsat}	–	–	0.9		
AC Characteristics						
Transition frequency $I_C = 20\text{ mA}, V_{CE} = 10\text{ V}, f = 100\text{ MHz}$	f_T	–	70	–	MHz	
Collector-base capacitance $V_{CB} = 20\text{ V}, f = 1\text{ MHz}$	C_{obo}	–	–	6	pF	
MPSA 92						
MPSA 93		–	–	8		

¹⁾ Pulse test conditions: $t \leq 300\text{ }\mu\text{s}, D \leq 2\text{ %}$.

Total power dissipation $P_{tot} = f(T_A; T_C)$

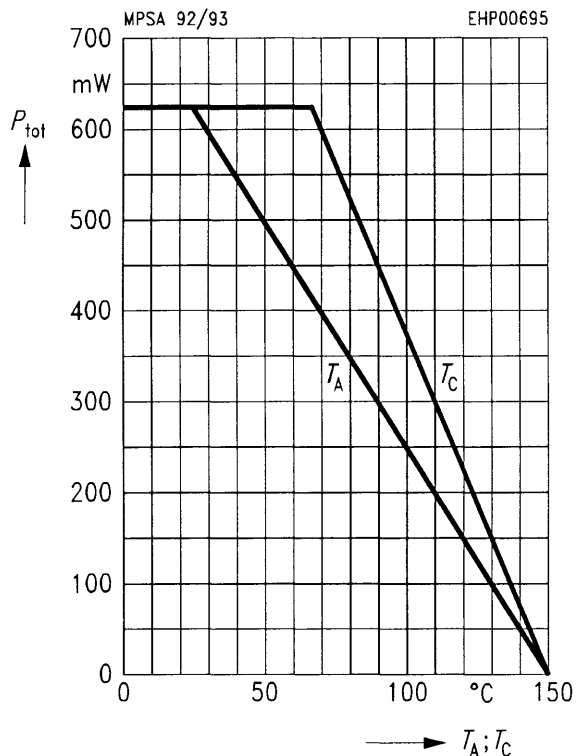

Permissible pulse load $R_{thJA} = f(t_p)$

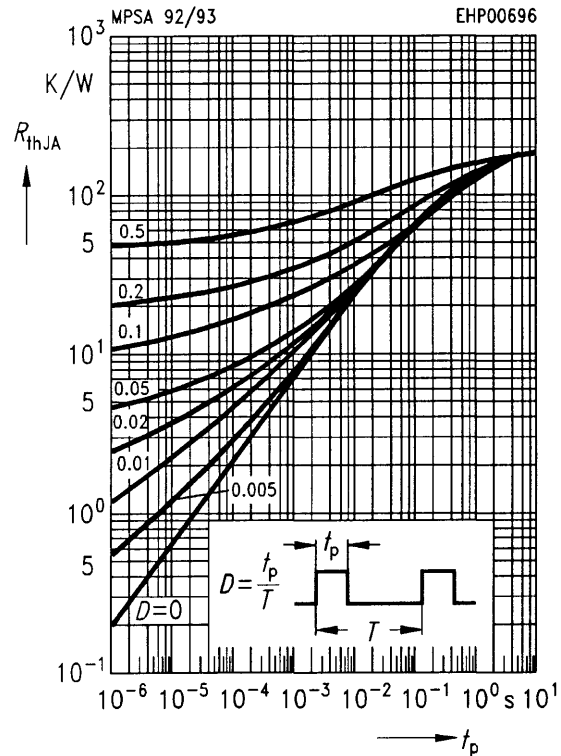

Operating range $I_c = f(V_{CE0})$
 $T_A = 25^\circ\text{C}, D = 0$

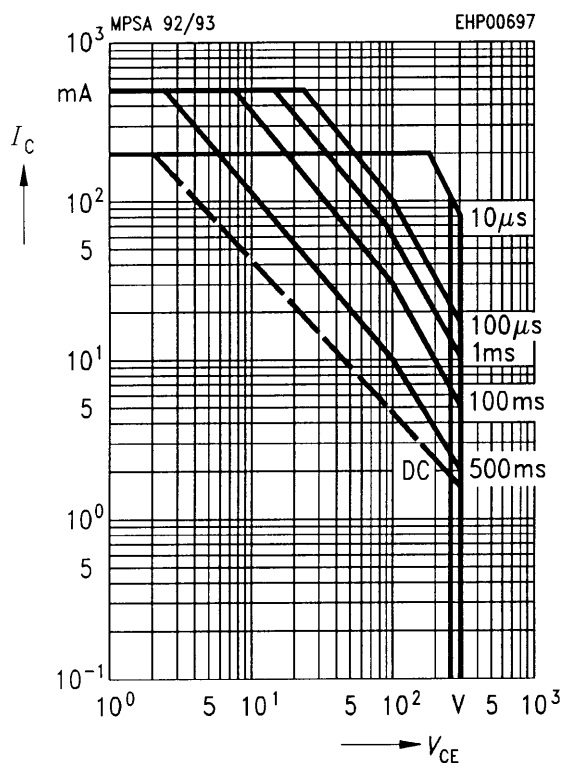

Collector cutoff current $I_{CB0} = f(T_A)$
 $V_{CB} = V_{CBmax}$

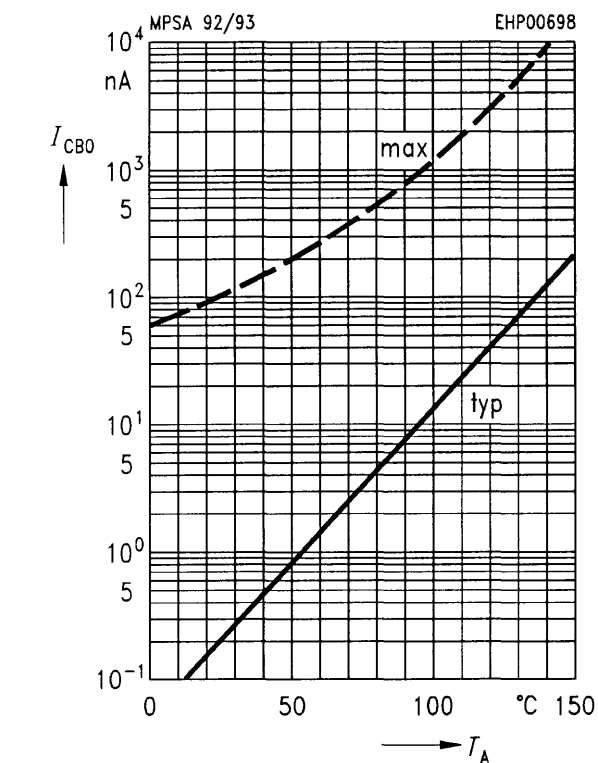

DC current gain $h_{FE} = f(I_C)$

$V_{CE} = 10 \text{ V}$

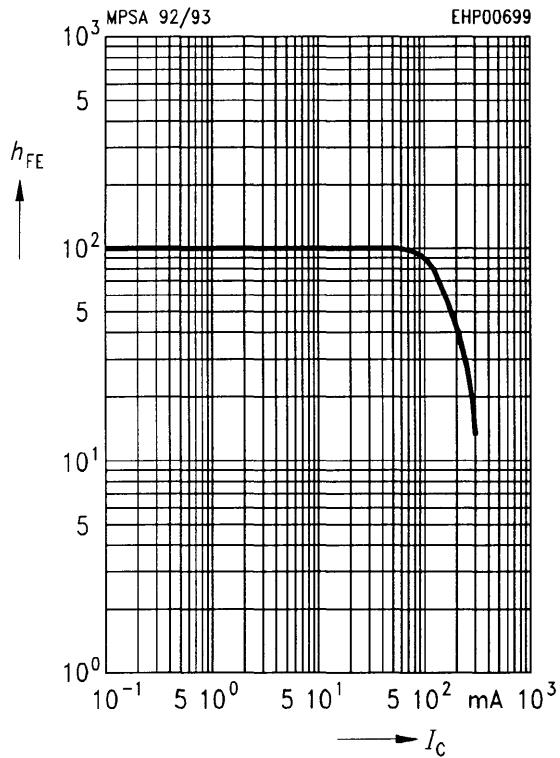

Transition frequency $f_T = f(I_C)$

$f = 20 \text{ MHz}, I_C = 20 \text{ mA}, V_{CE} = 10 \text{ V}$

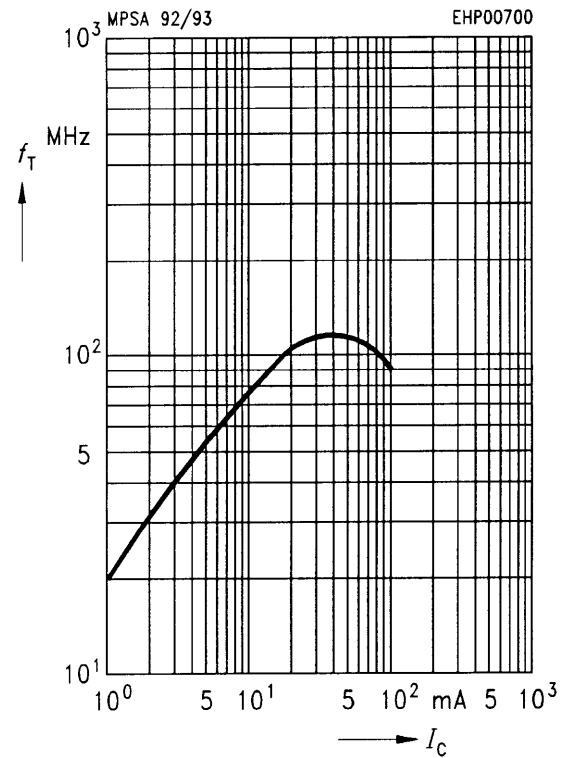

Collector current $I_C = f(V_{BE})$

$V_{CE} = 10 \text{ V}$

