

MPSA94G

Rev.E Mar.-2016

描述 / Descriptions

TO-92 塑封封装 PNP 半导体三极管。Silicon PNP transistor in a TO-92 Plastic Package.

特征 / Features

耐压高.无卤产品。

High voltage. HF Product.

用途 / Applications

用于高电压控制电路。

High voltage control circuit.

内部等效电路 / Equivalent Circuit

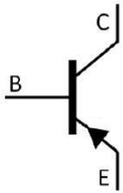

引脚排列 / Pinning



PIN1 : Collector PIN 2 : Base PIN 3 : Emitter

放大及印章代码 / hFE Classifications & Marking

见印章说明。See Marking Instructions.

极限参数 / Absolute Maximum Ratings(Ta=25°C)

参数 Parameter	符号 Symbol	数值 Rating	单位 Unit
Collector to Base Voltage	V_{CBO}	-400	V
Collector to Emitter Voltage	V_{CEO}	-400	V
Emitter to Base Voltage	V_{EBO}	-5.0	V
Collector Current - Continuous	I_C	-300	mA
Collector Power Dissipation	P_C	625	mW
Junction Temperature	T_j	150	°C
Storage Temperature Range	T_{stg}	-55~150	°C

电性能参数 / Electrical Characteristics(Ta=25°C)

参数 Parameter	符号 Symbol	测试条件 Test Conditions	最小值 Min	典型值 Typ	最大值 Max	单位 Unit
Collector to Base Breakdown Voltage	V_{CBO}	$I_C=-100\mu A$ $I_E=0$	-400			V
Collector to Emitter Breakdown Voltage	V_{CEO}	$I_C=-1.0mA$ $I_B=0$	-400			V
Emitter to Base Breakdown Voltage	V_{EBO}	$I_E=-100\mu A$ $I_C=0$	-5.0			V
Collector Cut-Off Current	I_{CBO}	$V_{CB}=-300V$ $I_E=0$			-0.1	μA
Collector Cut-Off Current	I_{CEO}	$V_{CE}=-400V$ $I_E=0$			-5.0	μA
Emitter Cut-Off Current	I_{EBO}	$V_{EB}=-4.0V$ $I_C=0$			-0.1	μA
DC Current Gain	$h_{FE(1)}$	$V_{CE}=-10V$ $I_C=-10mA$	80		300	
	$h_{FE(2)}$	$V_{CE}=-10V$ $I_C=-1.0mA$	70			
	$h_{FE(3)}$	$V_{CE}=-10V$ $I_C=-100mA$	40			
Collector to Emitter Saturation Voltage	$V_{CE(sat)(1)}$	$I_C=-10mA$ $I_B=-1.0mA$			-0.2	V
	$V_{CE(sat)(2)}$	$I_C=-50mA$ $I_B=-5.0mA$			-0.3	V
Base to Emitter Saturation Voltage	$V_{BE(sat)}$	$I_C=-10mA$ $I_B=-1.0mA$			-0.75	V
Transition Frequency	f_T	$V_{CE}=-5.0V$ $I_C=-10mA$ $f=30MHz$	50			MHz

电参数曲线图 / Electrical Characteristic Curve

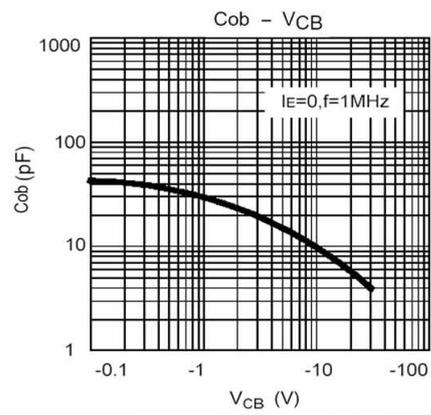
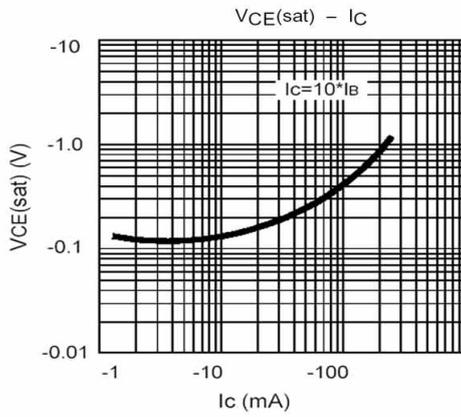
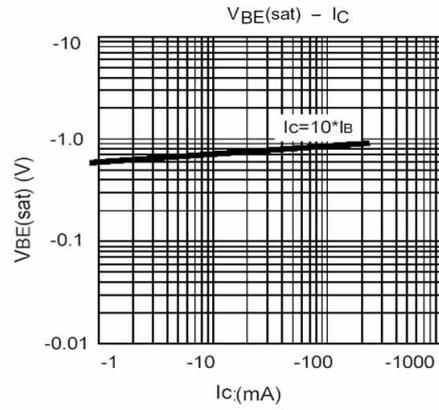
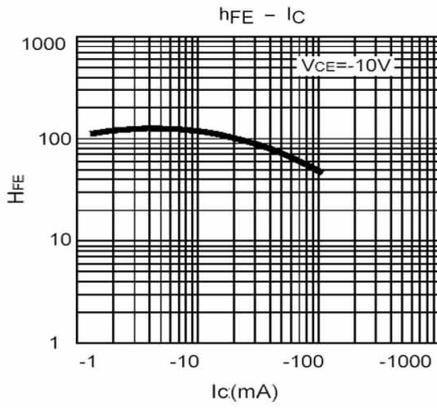

外形尺寸图 / Package Dimensions

TO-92

Unit: mm

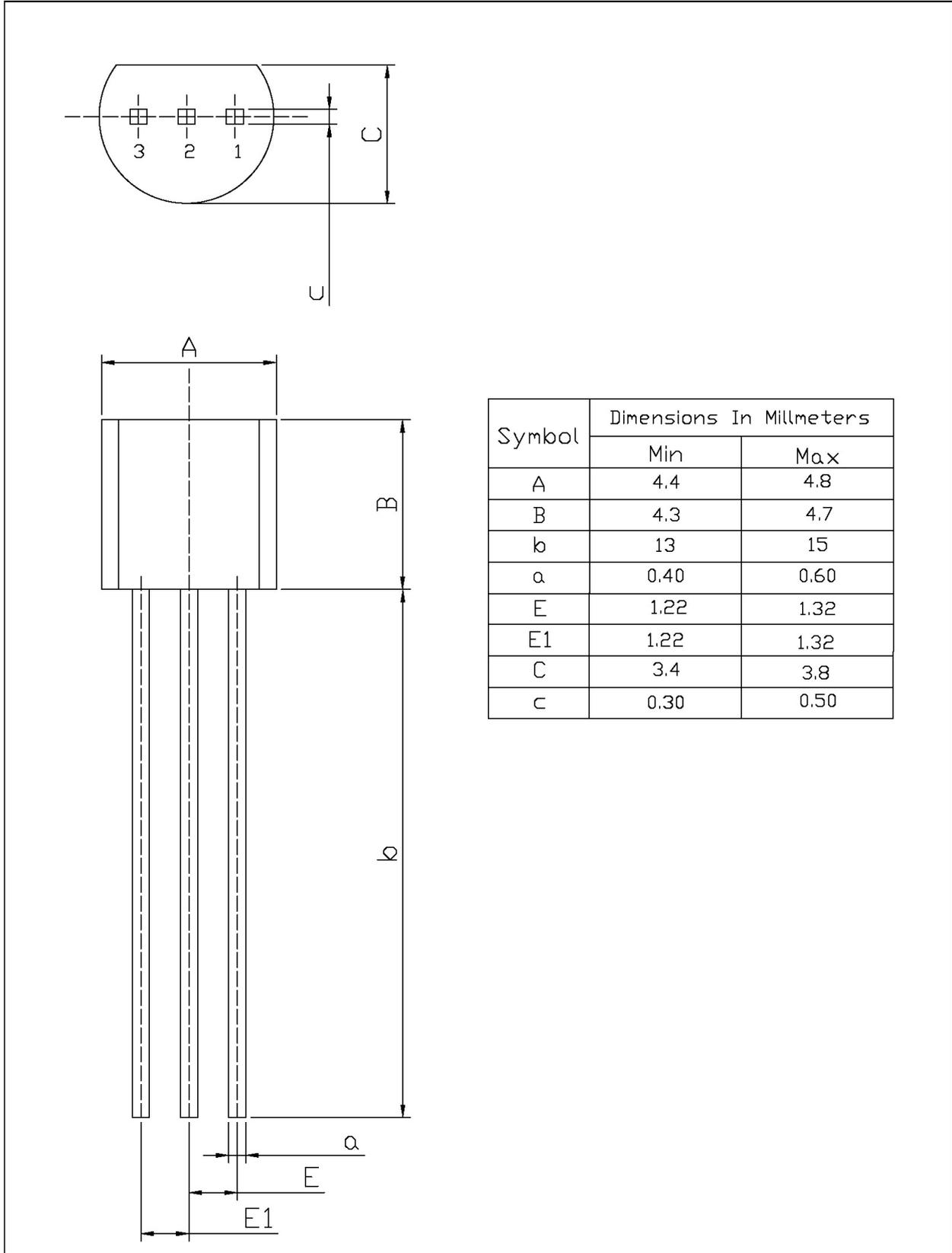

Symbol	Dimensions In Millimeters	
	Min	Max
A	4.4	4.8
B	4.3	4.7
b	13	15
a	0.40	0.60
E	1.22	1.32
E1	1.22	1.32
C	3.4	3.8
c	0.30	0.50

印章说明 / Marking Instructions

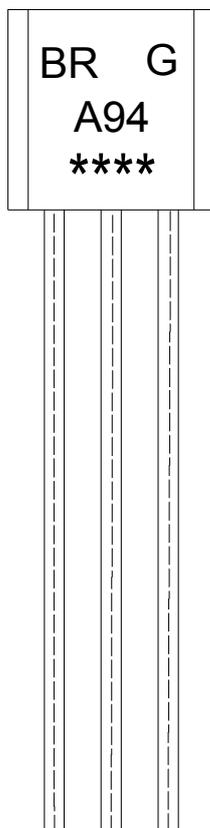

说明：

BR: 为公司代码

G: 为无卤产品代码

A94 : 为型号代码

**** : 为生产批号代码，随生产批号变化。

Note:

BR: Company Code.

G: Halogen Free Product

A94: Product Type.

****: Lot No. Code,code change with Lot No.

波峰焊温度曲线图(无铅) / Temperature Profile for Dip Soldering(Pb-Free)

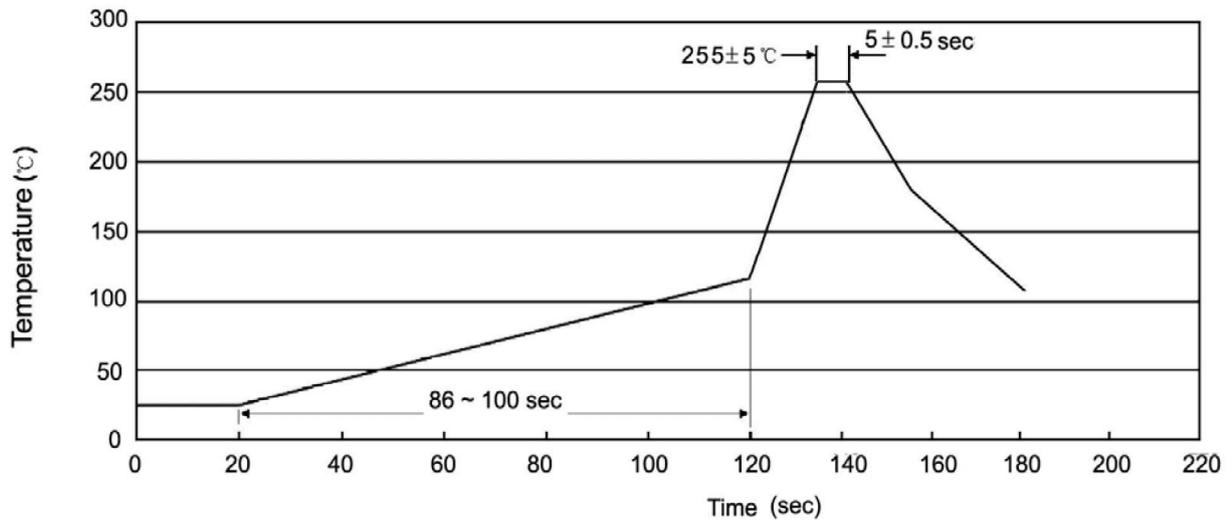

说明：

- 1、预热温度 25 ~ 150°C，时间 60 ~ 90sec;
- 2、峰值温度 255±5°C，时间持续为 5±0.5sec;
- 3、焊接制程冷却速度为 2 ~ 10°C/sec.

Note:

- 1.Preheating:25~150°C, Time:60~90sec.
- 2.Peak Temp.:255±5°C, Duration:5±0.5sec.
3. Cooling Speed: 2~10°C/sec.

耐焊接热试验条件 / Resistance to Soldering Heat Test Conditions

温度：270±5°C

时间：10±1 sec.

Temp:270±5°C

Time:10±1 sec

包装规格 / Packaging SPEC.

散件包装 / BULK

Package Type 封装形式	Units 包装数量					Dimension 包装尺寸 (unit: mm3)		
	Units/Bag 只/袋	Bags/Inner Box 袋/盒	Units/Inner Box 只/盒	Inner Boxes/Outer Box 盒/箱	Units/Outer Box 只/箱	Bag 袋	Inner Box 盒	Outer Box 箱
TO-92	1,000	10	10,000	5	50,000	135×190	237×172×102	560×245×195
	1,000	10	10,000	10	100,000	135×190	237×172×102	560×245×375

编带包装 / AMMO

Package Type 封装形式	Units 包装数量					Dimension 包装尺寸 (unit: mm3)	
	Units/tape 只/纸带	Tape/Inner Box 纸带/盒	Rows/Inner Box 纸带层/盒	Inner Boxes/Outer Box 盒/箱	Units/Outer Box 只/箱	Inner Box 盒	Outer Box 箱
TO-92	3,000	1	120	10	30,000	328×230×42	小箱 480×346×235, 大箱 547×407×268

使用说明 / Notices