

# The RF Sub-Micron MOSFET Line

## RF Power Field Effect Transistor Array

### N-Channel Enhancement-Mode Lateral MOSFET

Designed for broadband commercial and industrial applications with frequencies to 1.0 GHz. The high gain and broadband performance of this device make it ideal for large-signal, common-source amplifier applications in 26 volt base station equipment.

- Typical Performance at 960 MHz, 26 Volts  
Output Power — 2 Watts Per Transistor  
Power Gain — 18 dB  
Efficiency — 50%
- Designed for Maximum Gain and Insertion Phase Flatness
- Capable of Handling 10:1 VSWR, @ 26 Vdc, 960 MHz, 2 Watts CW Output Power
- Excellent Thermal Stability
- Characterized with Series Equivalent Large-Signal Impedance Parameters
- Available in Tape and Reel. R2 Suffix = 1,500 Units per 16 mm, 13 inch Reel.

**MRF9002R2**

**1.0 GHz, 2 W, 26 V  
LATERAL N-CHANNEL  
BROADBAND  
RF POWER MOSFET**

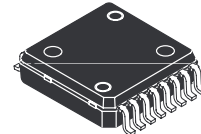

**CASE 978-03  
PLASTIC  
PFP-16**

#### PIN CONNECTIONS

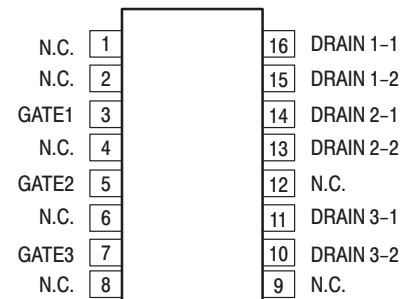

(Top View)

NOTE: Exposed backside flag is source terminal for transistors.

#### MAXIMUM RATINGS

Rating	Symbol	Value	Unit
Drain-Source Voltage	$V_{DSS}$	65	Vdc
Gate-Source Voltage	$V_{GS}$	-0.5, +15	Vdc
Total Dissipation Per Transistor @ $T_C = 25^\circ\text{C}$	$P_D$	4	Watts
Storage Temperature Range	$T_{stg}$	-65 to +150	$^\circ\text{C}$
Operating Junction Temperature	$T_J$	150	$^\circ\text{C}$

#### THERMAL CHARACTERISTICS

Characteristic	Symbol	Max	Unit
Thermal Resistance, Junction to Case, Single Transistor	$R_{\theta JC}$	12	$^\circ\text{C}/\text{W}$

#### MOISTURE SENSITIVITY LEVEL

Test Methodology	Rating
Per JESD 22-A113	3

NOTE – **CAUTION** – MOS devices are susceptible to damage from electrostatic charge. Reasonable precautions in handling and packaging MOS devices should be observed.

**ELECTRICAL CHARACTERISTICS** ( $T_C = 25^\circ\text{C}$  unless otherwise noted)

Characteristic	Symbol	Min	Typ	Max	Unit
<b>ON CHARACTERISTICS</b>					
Gate Threshold Voltage ( $V_{DS} = 10\text{ Vdc}$ , $I_D = 20\ \mu\text{Adc}$ )	$V_{GS(th)}$	2.4	—	4	Vdc
Gate Quiescent Voltage ( $V_{DS} = 26\text{ Vdc}$ , $I_D = 25\text{ mAdc}$ )	$V_{GS(Q)}$	3	—	5	Vdc
Drain–Source On–Voltage ( $V_{GS} = 10\text{ Vdc}$ , $I_D = 0.1\text{ Adc}$ )	$V_{DS(on)}$	—	0.3	—	Vdc

**FUNCTIONAL TESTS** (Per Transistor in Motorola Test Fixture, 50 ohm system)

Common–Source Amplifier Power Gain @ P1dB ( $V_{DD} = 26\text{ Vdc}$ , $I_{DQ} = 25\text{ mA}$ , $f = 960.0\text{ MHz}$ )	$G_{ps}$	15	18	—	dB
Drain Efficiency @ P1dB ( $V_{DD} = 26\text{ Vdc}$ , $I_{DQ} = 25\text{ mA}$ , $f = 960.0\text{ MHz}$ )	$\eta$	35	50	—	%
Input Return Loss @ P1dB ( $V_{DD} = 26\text{ Vdc}$ , $I_{DQ} = 25\text{ mA}$ , $f = 960.0\text{ MHz}$ )	IRL	—	–15	–9	dB
Power Output, 1 dB Compression Point ( $V_{DD} = 26\text{ Vdc}$ , $I_{DQ} = 25\text{ mA}$ , $f = 960.0\text{ MHz}$ )	$P_{1dB}$	34	37	—	dBm
Output Mismatch Stress ( $V_{DD} = 26\text{ Vdc}$ , $P_{out} = 2\text{ W CW}$ , $I_{DQ} = 25\text{ mA}$ , $f = 960.0\text{ MHz}$ , $VSWR = 10:1$ , All Phase Angles at Frequency of Tests)	$\Psi$	No Degradation In Output Power			

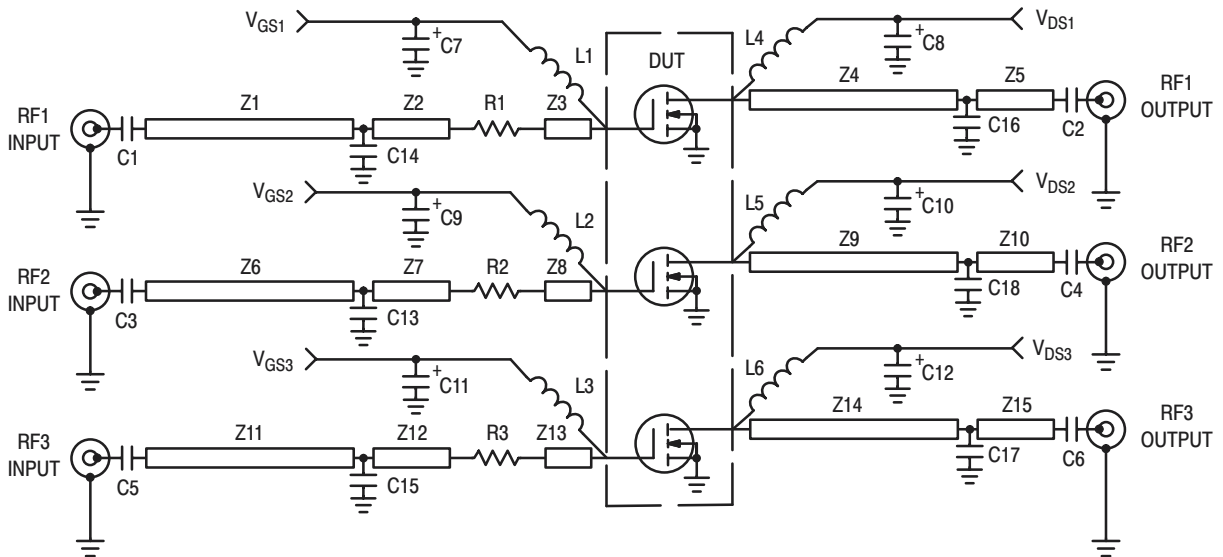

Figure 1. MRF9002R2 Broadband Test Circuit Schematic

Table 1. MRF9002R2 Broadband Test Circuit Component Designations and Values

Designators	Description
C1–C6	33 pF Chip Capacitors (0805)
C7–C12	1.0 $\mu$ F, 35 V Tantalum Capacitors, B Case, Kemet
C13	8.2 pF Chip Capacitor (0805)
C14, C15	10 pF Chip Capacitors (0805)
C16, C17	2.7 pF Chip Capacitors (0805)
C18	3.3 pF Chip Capacitor (0805)
L1–L6	12 nH Chip Inductors (0805)
R1–R3	0 $\Omega$ Chip Resistors (0805)
Z1, Z11	1.16 x 28.5 mm Microstrip
Z2, Z7, Z12	0.65 x 5.6 mm Microstrip
Z3, Z8, Z13	0.65 x 2.6 mm Microstrip
Z4, Z14	1.16 x 19.5 mm Microstrip
Z5, Z15	1.16 x 17.5 mm Microstrip
Z6	1.16 x 12.9 mm Microstrip
Z9	1.16 x 27.2 mm Microstrip
Z10	1.16 x 4.3 mm Microstrip
PCB	Etched Circuit Board
Raw PCB Material	Rogers RO4350, 0.020", 2.5", x 2.5", $\epsilon_r = 3.5$
Bedstead	Copper Heatsink

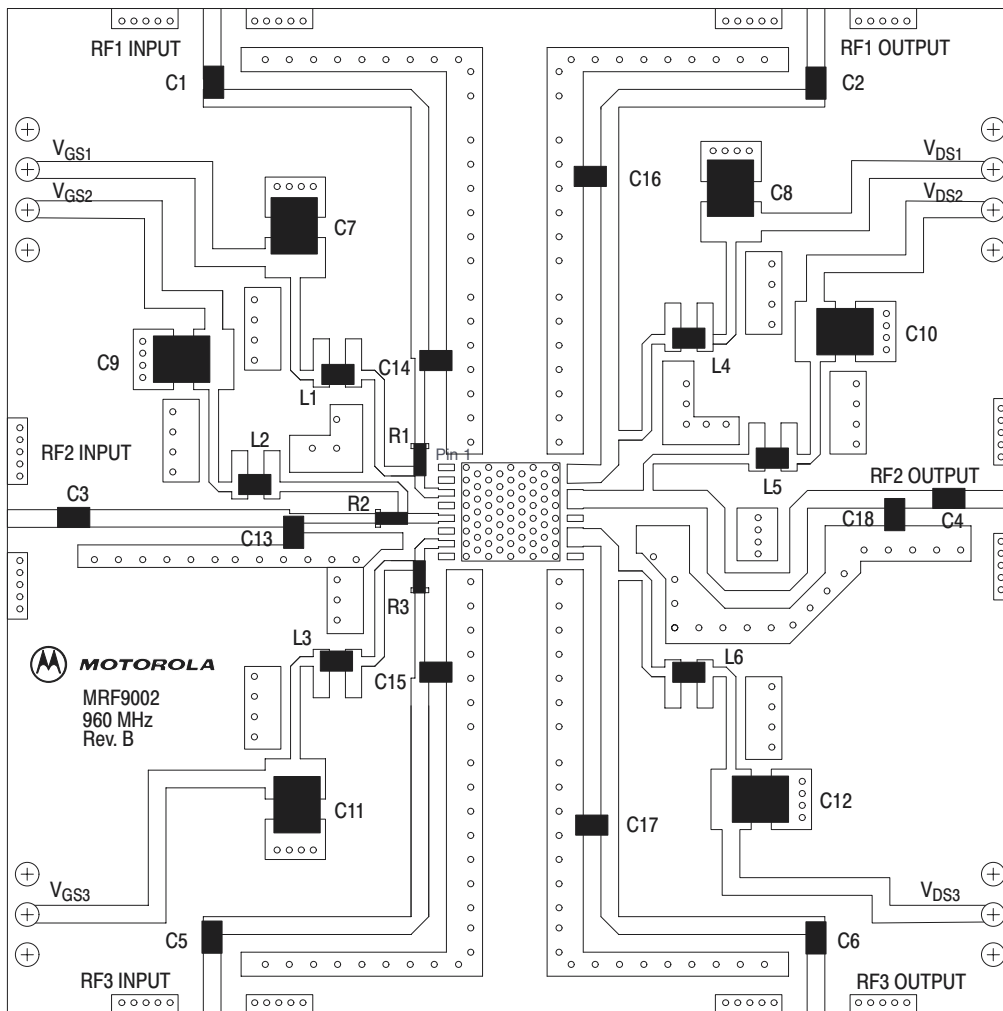
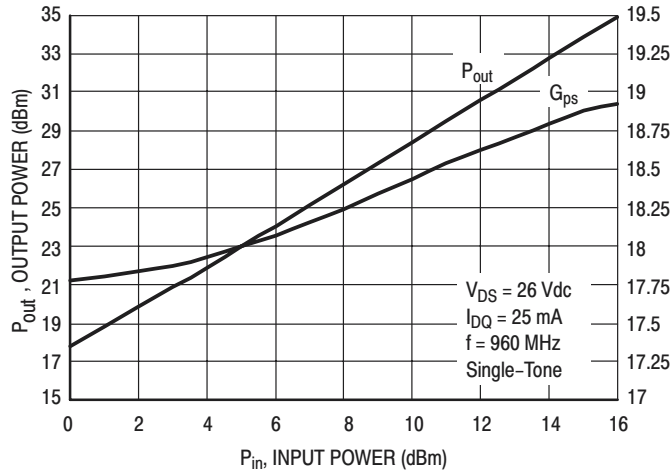
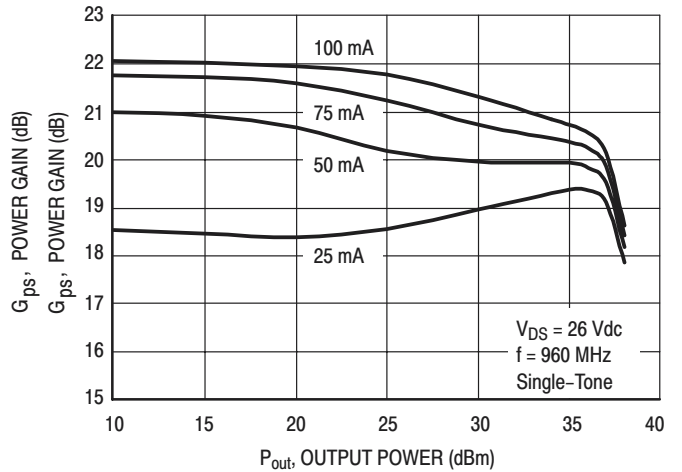

Figure 2. MRF9002R2 Broadband Test Circuit Component Layout

## TYPICAL CHARACTERISTICS



**Figure 3. Output Power and Power Gain versus Input Power**



**Figure 4. Power Gain versus Output Power**

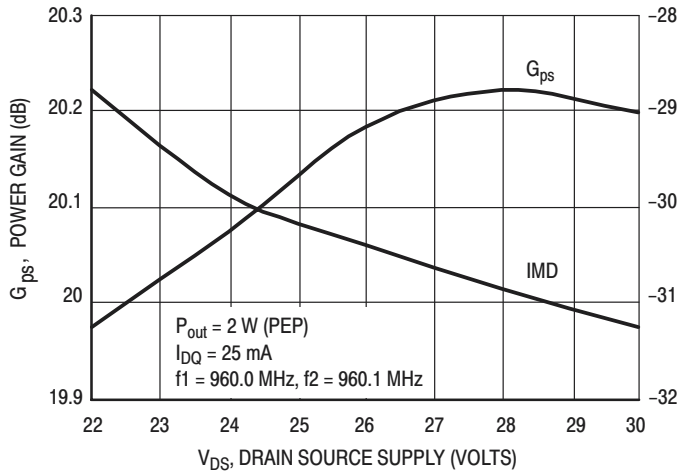

**Figure 5. Power Gain and Intermodulation Distortion versus Supply Voltage**

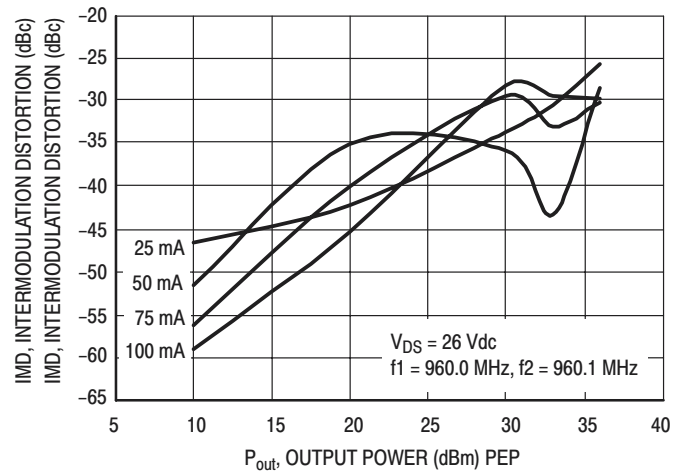

**Figure 6. Intermodulation Distortion versus Output Power**

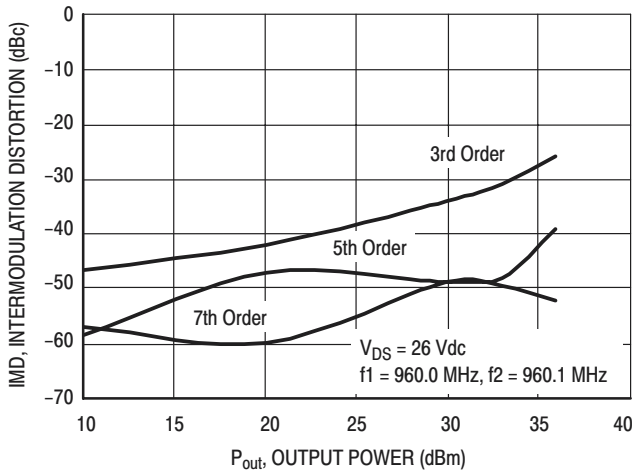

**Figure 7. Intermodulation Distortion Products versus Output Power**

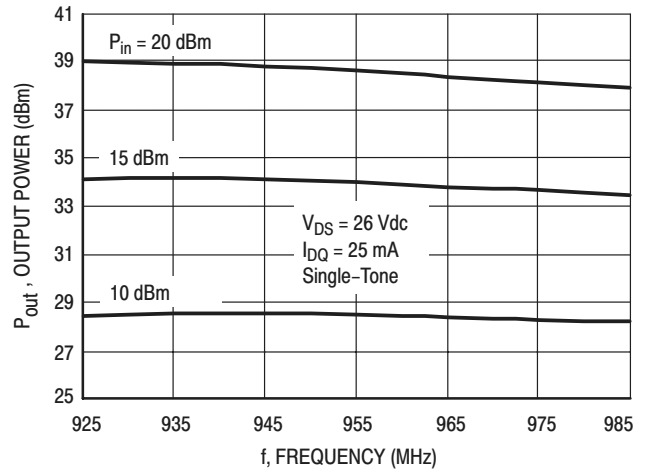

**Figure 8. Output Power versus Frequency**

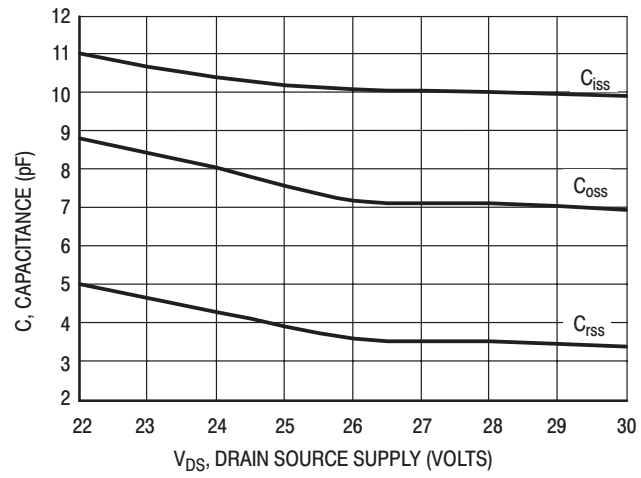

**Figure 9. Capacitance versus Drain Source Voltage**

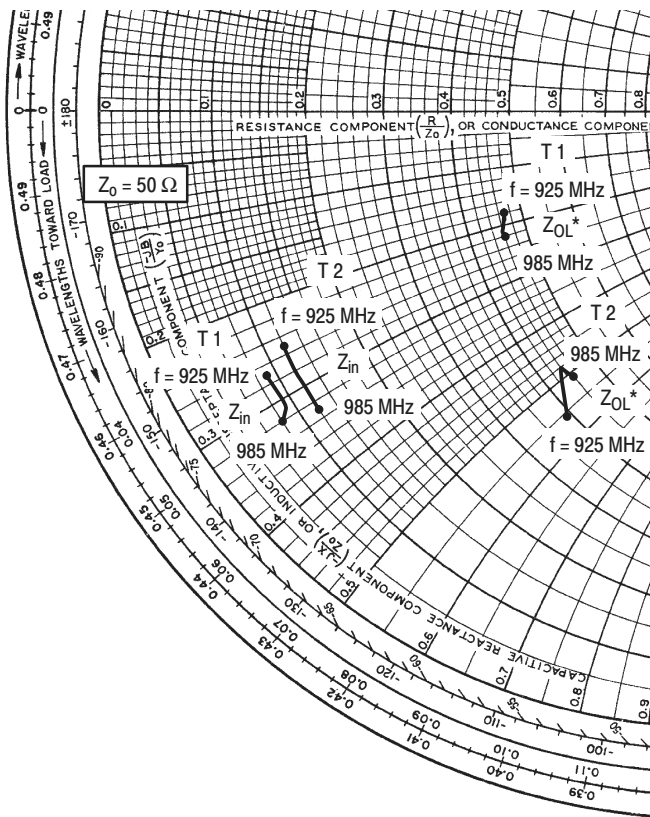

TRANSISTORS 1 and 2

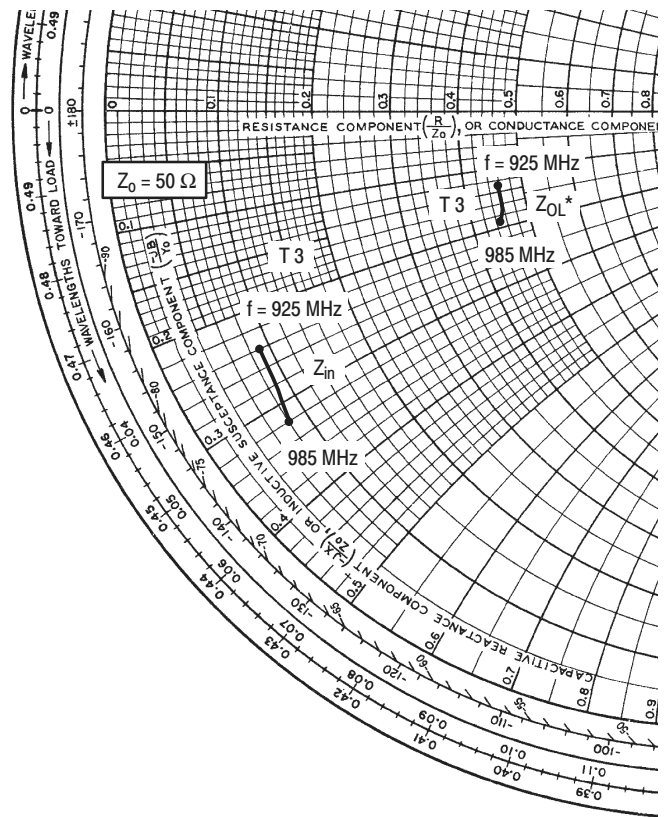

TRANSISTOR 3

$V_{DD} = 26\text{ V}$ ,  $I_{DQ} = 25\text{ mA}$ ,  $P_{out} = 2\text{ W PEP}$

f MHz	$Z_{in}$ $\Omega$	$Z_{OL}^*$ $\Omega$
925	$4.5 - j13.3$	$23.4 - j9.2$
960	$4.3 - j15.3$	$23.2 - j10.4$
985	$4.1 - j15.8$	$23.0 - j11.1$

Transistor 1

$V_{DD} = 26\text{ V}$ ,  $I_{DQ} = 25\text{ mA}$ ,  $P_{out} = 2\text{ W PEP}$

f MHz	$Z_{in}$ $\Omega$	$Z_{OL}^*$ $\Omega$
925	$6.0 - j12.3$	$19.7 - j27.8$
960	$5.9 - j14.3$	$22.0 - j23.9$
985	$5.8 - j16.5$	$22.5 - j25.4$

Transistor 2

$V_{DD} = 26\text{ V}$ ,  $I_{DQ} = 25\text{ mA}$ ,  $P_{out} = 2\text{ W PEP}$

f MHz	$Z_{in}$ $\Omega$	$Z_{OL}^*$ $\Omega$
925	$4.3 - j12.2$	$23.1 - j6.5$
960	$4.3 - j14.0$	$22.8 - j8.4$
985	$3.9 - j15.9$	$22.6 - j9.3$

Transistor 3

$Z_{in}$  = Complex conjugate of source impedance.

$Z_{OL}^*$  = Complex conjugate of the optimum load impedance at a given output power, voltage, IMD, bias current and frequency.

Note:  $Z_{OL}^*$  was chosen based on tradeoffs between gain, output power, drain efficiency and intermodulation distortion.

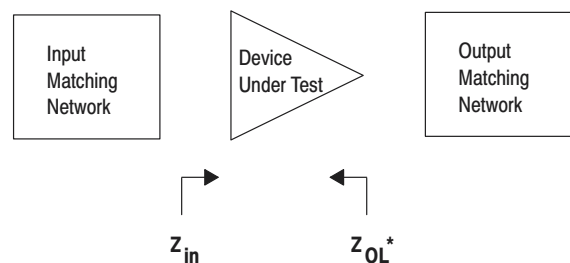

Figure 10. Series Equivalent Input and Output Impedance

# NOTES



# NOTES

# NOTES

# PACKAGE DIMENSIONS

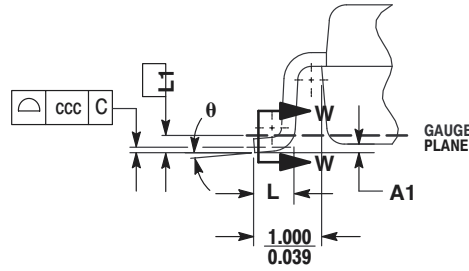
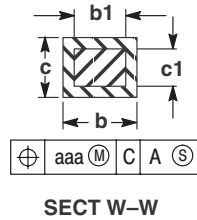
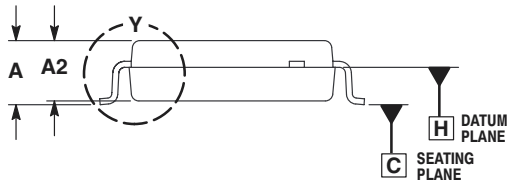
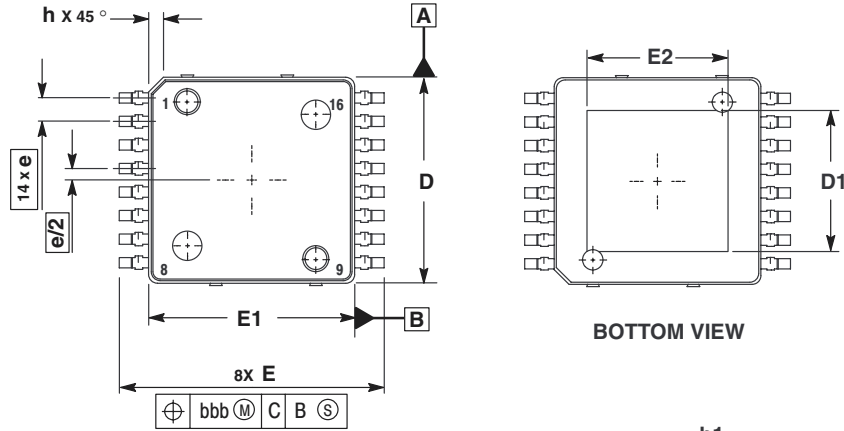

- NOTES:
1. CONTROLLING DIMENSION: MILLIMETER.
  2. DIMENSIONS AND TOLERANCES PER ASME Y14.5M, 1994.
  3. DATUM PLANE -H- IS LOCATED AT BOTTOM OF LEAD AND IS COINCIDENT WITH THE LEAD WHERE THE LEAD EXITS THE PLASTIC BODY AT THE BOTTOM OF THE PARTING LINE.
  4. DIMENSIONS D AND E1 DO NOT INCLUDE MOLD PROTRUSION. ALLOWABLE PROTRUSION IS 0.250 PER SIDE. DIMENSIONS D AND E1 DO INCLUDE MOLD MISMATCH AND ARE DETERMINED AT DATUM PLANE -H-.
  5. DIMENSION b DOES NOT INCLUDE DAMBAR PROTRUSION. ALLOWABLE DAMBAR PROTRUSION IS 0.127 TOTAL IN EXCESS OF THE b DIMENSION AT MAXIMUM MATERIAL CONDITION.
  6. DATUMS -A- AND -B- TO BE DETERMINED AT DATUM PLANE -H-.

DIM	MILLIMETERS	
	MIN	MAX
A	2.000	2.300
A1	0.025	0.100
A2	1.950	2.100
D	6.950	7.100
D1	4.372	5.180
E	8.850	9.150
E1	6.950	7.100
E2	4.372	5.180
L	0.466	0.720
L1	0.250 BSC	
b	0.300	0.432
b1	0.300	0.375
c	0.180	0.279
c1	0.180	0.230
e	0.800 BSC	
h	---	0.600
theta	0°	7°
aaa	0.200	
bbb	0.200	
ccc	0.100	

CASE 978-03  
 ISSUE B  
 PLASTIC  
 PFP-16

Motorola reserves the right to make changes without further notice to any products herein. Motorola makes no warranty, representation or guarantee regarding the suitability of its products for any particular purpose, nor does Motorola assume any liability arising out of the application or use of any product or circuit, and specifically disclaims any and all liability, including without limitation consequential or incidental damages. "Typical" parameters which may be provided in Motorola data sheets and/or specifications can and do vary in different applications and actual performance may vary over time. All operating parameters, including "Typicals" must be validated for each customer application by customer's technical experts. Motorola does not convey any license under its patent rights nor the rights of others. Motorola products are not designed, intended, or authorized for use as components in systems intended for surgical implant into the body, or other applications intended to support or sustain life, or for any other application in which the failure of the Motorola product could create a situation where personal injury or death may occur. Should Buyer purchase or use Motorola products for any such unintended or unauthorized application, Buyer shall indemnify and hold Motorola and its officers, employees, subsidiaries, affiliates, and distributors harmless against all claims, costs, damages, and expenses, and reasonable attorney fees arising out of, directly or indirectly, any claim of personal injury or death associated with such unintended or unauthorized use, even if such claim alleges that Motorola was negligent regarding the design or manufacture of the part. Motorola, Inc. Motorola, Inc. is an Equal Opportunity/Affirmative Action Employer. MOTOROLA and the  logo are registered in the US Patent & Trademark Office. All other product or service names are the property of their respective owners.

© Motorola, Inc. 2002.

**How to reach us:**

**USA/EUROPE/Locations Not Listed:** Motorola Literature Distribution; P.O. Box 5405, Denver, Colorado 80217. 1-303-675-2140 or 1-800-441-2447

**JAPAN:** Motorola Japan Ltd.; SPS, Technical Information Center, 3-20-1, Minami-Azabu. Minato-ku, Tokyo 106-8573 Japan. 81-3-3440-3569

**ASIA/PACIFIC:** Motorola Semiconductors H.K. Ltd.; Silicon Harbour Centre, 2 Dai King Street, Tai Po Industrial Estate, Tai Po, N.T., Hong Kong. 852-26668334

**Technical Information Center: 1-800-521-6274**

**HOME PAGE:** <http://www.motorola.com/semiconductors/>

