

## The MRFIC Line 1.8 GHz PA Driver/Ramp

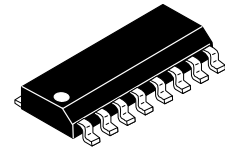
Designed primarily for use in DECT, Japan Personal Handy System (PHS), and other wireless Personal Communication Systems (PCS) applications. The MRFIC1806 includes a two stage driver amplifier and transmit waveform shaping circuitry in a low-cost SOIC-16 package. The amplifier portion employs depletion mode power GaAs MESFETs to produce +21 dBm output with 0 dBm input. The ramping circuit controls the burst-mode transmit rise and fall time and is adjustable through external components. This circuitry also places the amplifier in standby during TDMA receive mode. The MRFIC1806 is sized to drive the MRFIC1807 PA/Switch.

Together with the rest of the MRFIC1800 GaAs ICs, this family offers the complete transmit and receive functions, less LO and filters, needed for a typical 1.8 GHz cordless telephone.

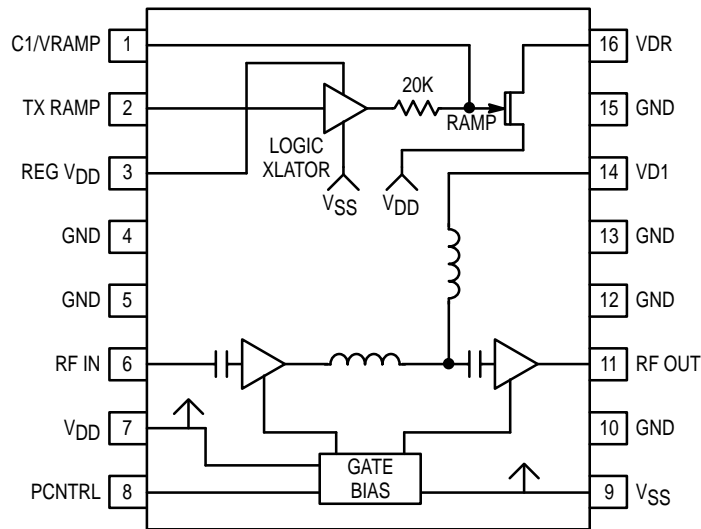
- Usable 1500–2500 MHz
- 23 dB Typical Gain
- +21 dBm Typical 1.0 dB Compression
- Simple Off-Chip Matching for Maximum Flexibility
- 3.0 to 5.0 Volt Supply
- Low Cost Surface Mount Plastic Package
- Order MRFIC1806R2 for Tape and Reel.  
R2 Suffix = 2,500 Units per 16 mm, 13 inch Reel.
- Device Marking = M1806

# MRFIC1806

**1.8 GHz DRIVER AMPLIFIER  
AND RAMP CIRCUIT  
GaAs MONOLITHIC  
INTEGRATED CIRCUIT**



**CASE 751B-05  
(SO-16)**



**Figure 1. Pin Connections and Functional Block Diagram**

**ABSOLUTE MAXIMUM RATINGS** ( $T_A = 25^\circ\text{C}$  unless otherwise noted)

Rating	Symbol	Limit	Unit
Supply Voltage	$V_{DD}$	6.0	Vdc
Supply Voltage	$V_{SS}$	-4.0	Vdc
Supply Voltage	REG $V_{DD}$	4.5	Vdc
Bias Control Voltage	PCNTRL	3.0	Vdc
RF Input Power	$P_{IN}$	10	dBm
Ramp Circuit Input Voltage (High)	TX RAMP	6.0	Vdc
Storage Temperature Range	$T_{stg}$	-65 to +150	$^\circ\text{C}$
Ambient Operating Temperature	$T_A$	-10 to +70	$^\circ\text{C}$
Thermal Resistance, Junction to Case	$\theta_{JC}$	100	$^\circ\text{C/W}$

**RECOMMENDED OPERATING RANGES**

Parameter	Symbol	Value	Unit
RF Input Frequency	$f_{RF}$	1.5–2.5	GHz
Supply Voltage	$V_{DD}$	3.0 to 5.0	Vdc
Supply Voltage	$V_{SS}$	-2.75 to -2.25	Vdc
Supply Voltage	REG $V_{DD}$	2.9 to 3.1	Vdc
Bias Control Voltage	PCNTRL	0.5 to 1.5	Vdc
RF Input Power	$P_{IN}$	-20 to +5	dBm
Transmit Burst Enable Voltage (High)	TX RAMP	2.8 to 3.5	Vdc
Transmit Burst Enable Voltage (Low)	TX RAMP	-0.2 to +0.2	Vdc

## ELECTRICAL CHARACTERISTICS

**DECT Application with Internal Logic Translator** (See Figure 2.  $V_{DD} = 3.5\text{ V}$ ,  $REG\ V_{DD} = 3.0\text{ V}$ ,  $T_A = 25^\circ\text{C}$ ,  $V_{SS} = -2.5\text{ V}$ ,  $TX\ RAMP = 3.0\text{ V}$ ,  $PCNTRL$  set for Quiescent  $I_{DD} = 120\text{ mA}$ ,  $P_{IN} = -3.0\text{ dBm}$  @  $1.9\text{ GHz}$  unless otherwise stated.)

Characteristic	Min	Typ	Max	Unit
Small Signal Gain ( $P_{IN} = -7.0\text{ dBm}$ )	21	23	—	dB
Input Return Loss	—	12	—	dB
Reverse Isolation	—	36	—	dB
Output Power	18	19.5	—	dBm
Harmonic Output	—	-36	—	dBc
Output Third Order Intercept	—	33	—	dBm
Supply Current, $I_{SS}$ (Pin 9)	—	0.35	0.6	mA
Supply Current, $I_{DD}$ (Pin 7)	—	115	135	mA
Supply Current, $REG\ I_{DD}$ (Pin 3)	—	0.6	0.9	mA
Ramp Circuit Dynamic Range	40	44	—	dB

## STANDBY MODE ( $TX\ RAMP = 0\text{ V}$ )

Characteristic	Min	Typ	Max	Unit
Output Power	—	-25	—	dBm
Supply Current, $I_{SS}$ (Pin 9)	—	0.4	0.6	mA
Supply Current, $REG\ I_{DD}$ (Pin 3)	—	0.25	0.4	mA

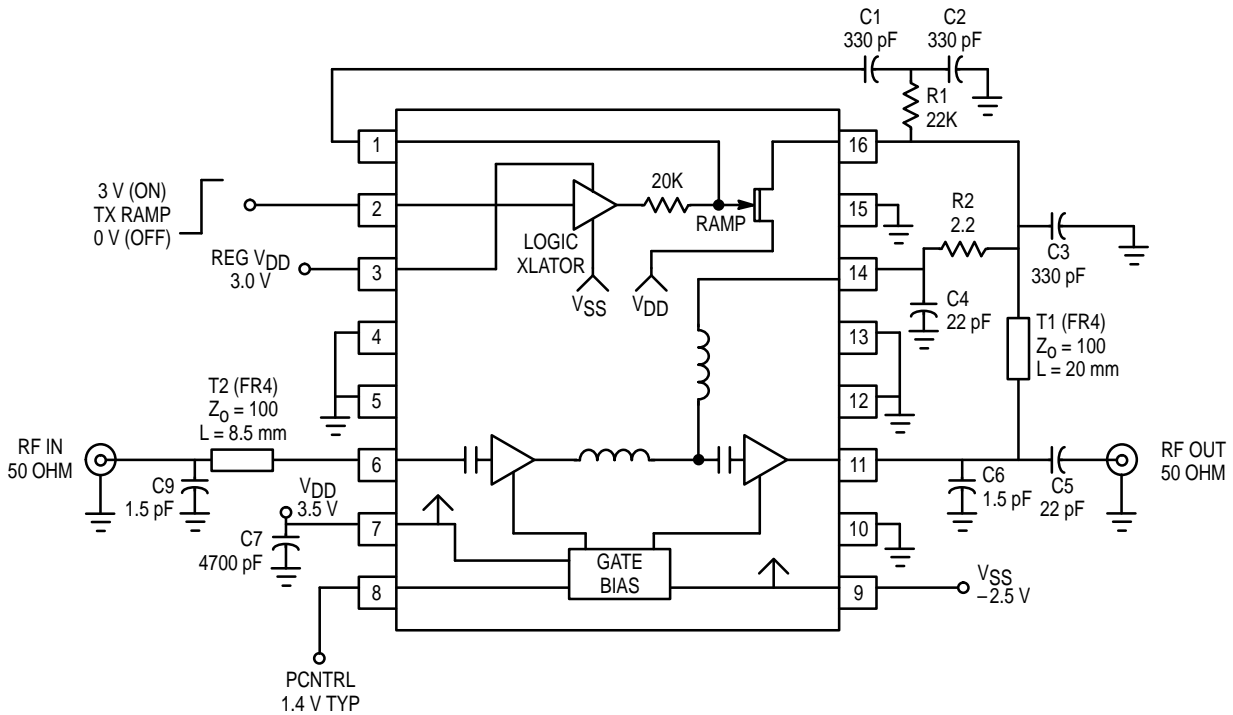


Figure 2. Applications Circuit Details for DECT using Internal Logic Translator

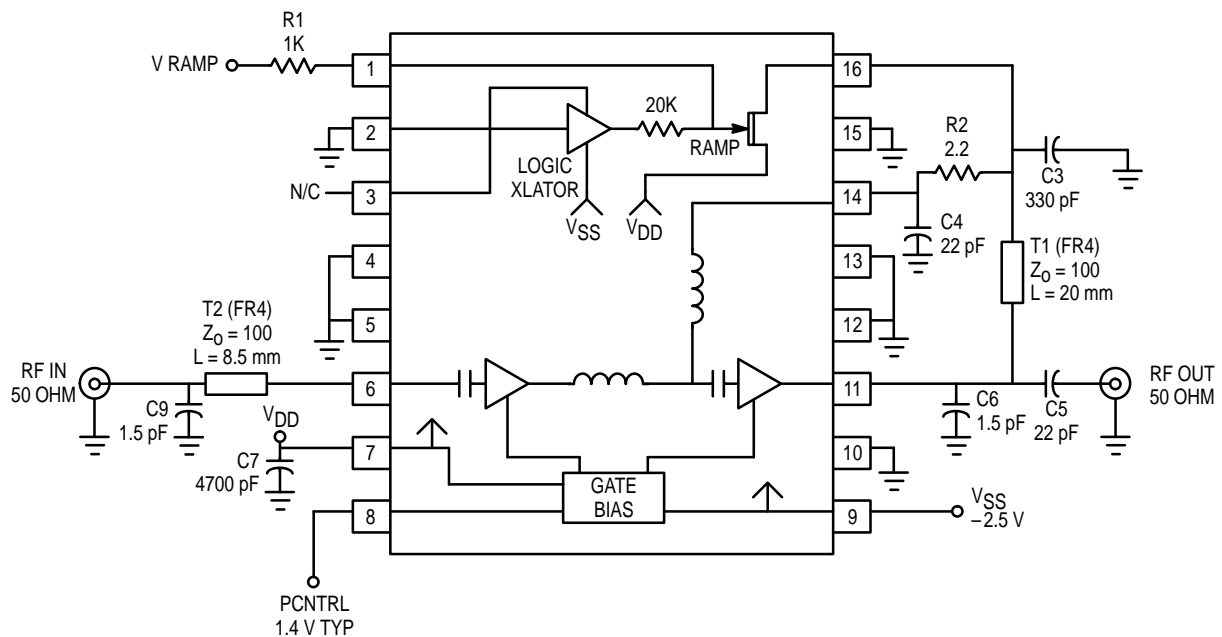
## ELECTRICAL CHARACTERISTICS

**General Application without Internal Logic Translator** (See Figure 3.  $V_{DD} = 3.5\text{ V}$ , REG  $V_{DD}$  (Pin 2) open,  $V_{SS} = -2.5\text{ V}$ , TX RAMP (Pin 2) grounded,  $V_{RAMP} = 3.0\text{ V}$ , PCNTRL set for Quiescent  $I_{DD} = 120\text{ mA}$ ,  $P_{IN} = 0\text{ dBm}$  @  $1.9\text{ GHz}$ ,  $T_A = 25^\circ\text{C}$  unless otherwise stated.)

Characteristic	Min	Typ	Max	Unit
Small Signal Gain ( $P_{IN} = -7.0\text{ dBm}$ )	21	23	—	dB
Output Power ( $P_{IN} = 0\text{ dBm}$ )	20	22	—	dBm
Output Power ( $P_{IN} = +4.0\text{ dBm}$ )	—	23	—	dBm
Supply Current, $I_{SS}$ (Pin 9)	—	0.3	0.5	mA
Supply Current, $I_{DD}$ (Pin 7)	—	130	145	mA

## STANDBY MODE ( $V_{RAMP} = -2.4\text{ V}$ )

Characteristic	Min	Typ	Max	Unit
Output Power	—	-25	—	dBm
Supply Current, $I_{SS}$ (Pin 9)	—	0.4	0.6	mA



**Figure 3. 1.9 GHz General Application Circuit Details (Internal Translator Disabled)**

**Table 1. Small Signal S-Parameters**

( $V_{DD} = 3.5\text{ V}$ ,  $I_{DQ} = 120\text{ mA}$ ,  $T_A = 25^\circ\text{C}$ , no matching circuit, reference plane at pins 6 and 11.)

Freq (GHz)	S <sub>11</sub>		S <sub>21</sub>		S <sub>12</sub>		S <sub>22</sub>	
	Mag	Angle	Mag	Angle	Mag	Angle	Mag	Angle
1.5	0.734	-76.8	13.11	-87.9	0.009	-176	0.278	-98.9
1.6	0.654	-82.4	13.01	-109.4	0.012	178	0.326	-116.4
1.7	0.620	-72.6	11.17	-117.4	0.011	152	0.344	-109.8
1.8	0.636	-79.8	12.25	-137.0	0.014	170	0.423	-134.1
1.9	0.607	-80.6	10.77	-151.3	0.017	169	0.421	-147.7
2.0	0.592	-79.4	10.88	-165.1	0.019	163	0.427	-161.8
2.1	0.581	-79.4	9.64	-174.9	0.024	163	0.432	-172.3
2.2	0.571	-78.9	9.30	174.1	0.026	158	0.429	178.8
2.3	0.560	-79.1	7.95	166.9	0.029	157	0.432	171.1
2.4	0.541	-79.8	7.80	155.7	0.033	153	0.442	164.6
2.5	0.521	-80.1	6.90	147.2	0.042	154	0.445	161.7

## DESIGN AND APPLICATIONS INFORMATION

### DESIGN PHILOSOPHY

The MRFIC1806 is designed to drive the MRFIC1807 Power Amplifier and Transmit/Receive Switch IC in Personal Communications System (PCS) applications such as Europe's DECT and Japan's Personal Handy System (PHS). The design incorporates not only a two-stage GaAs MESFET driver/exciter amplifier, but also externally controllable bias and ramping circuitry. The IC is designed to drive the MRFIC1807 with about +19 dBm which will, in turn, produce +26 dBm output, suitable for DECT. To reduce chip size (and cost) and to allow for flexibility of application, the amplifier has limited on-chip matching. The ramp circuitry is used to shape the drain voltage to the FETs for Time Domain Multiple Access (TDMA) applications and is comprised of a depletion mode pass device driven by a logic translator. Attack and release times are controllable through the use of external components. The IC is configured such that all, part or none of the ramping circuitry can be used, depending on the application.

### AMPLIFIER CIRCUIT APPLICATION

As can be seen in Figures 2 and 3, the off-chip matching is straight forward. At frequencies near 1.9 GHz, the input requires 4.7 nH in series and 1.5 pF in shunt. The 4.7 nH series inductance may be implemented with a high-impedance transmission line as shown. The output, being close to 25  $\Omega$ , requires only a shunt 1.5 pF capacitor. Drain voltage for stage 1 is supplied through pin 14 and for stage 2 through pin 11, the RF output. Pin 8, PCNTRL is used to set the quiescent bias point for both stages. While nominal  $I_{DDQ}$  is 120 mA, it can be set as high as 180 mA for better linearity or lower for better efficiency. 120 mA is a good compromise for DECT and PHS. DECT, which employs GMSK constant envelope modulation can use RF amplifiers close to or in saturation without experiencing spectral regrowth of the signal. PHS, on the other hand, employs  $\pi/4$  DQPSK modulation which has some residual AM associated with the encoding. With AM present, RF amplifiers must be backed off from saturation so as not to regrow the filtered sidebands. The MRFIC1806 has plenty of backoff capability for PHS where the MRFIC1807 PA/switch must only produce about +21 dBm. With the 8.0 dB gain of the MRFIC1807, the MRFIC1806 need only produce +13 dBm output so the bias point can be reduced below the 120 mA suggested for DECT.

As with all RF circuits, board layout and grounding are important. All RF signal paths must be controlled impedance structures. RF chip components must be high quality. Bypassing capacitors must be close to the IC and to ground vias. Pins which are designated as ground connections must be as close as possible to ground vias.

### RAMPING CIRCUIT OPTIONS

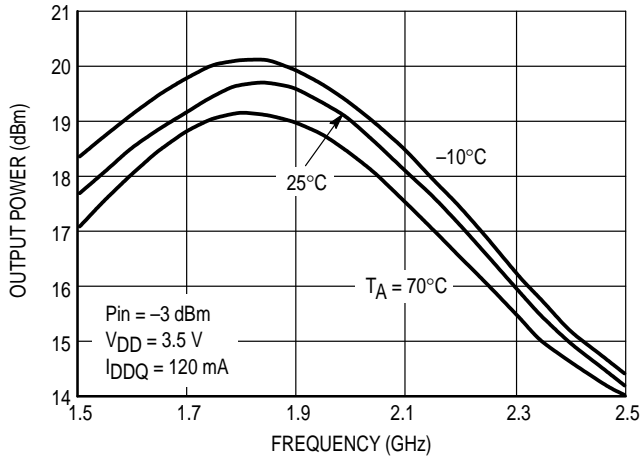
The on-chip ramp circuit can be used to control the amplifier attack and release time for DECT applications through the use of a few external components as shown in Figure 2. This ramping is required to control the burst signal rise and fall time to avoid adjacent channel interference. At the same time, system specifications require the transmitter to reach full power in a minimum time. For DECT, it has been shown that a rise time of not greater than 2 microseconds will produce acceptable adjacent channel performance. The system requires full power in not greater than 10 microseconds. A good compromise, and the timing implemented in Figure 2, is 7 microseconds.

The on-chip logic translator can be bypassed as shown in Figure 3 by applying a ramp voltage to Pin 1 through a 1.0 k $\Omega$  resistor. This configuration allows flexibility in ramping the amplifier. The regulated  $V_{DD}$  voltage is not required so current consumption can be reduced. -2.3 V at Pin 1 turns the pass transistor, and the amplifier, off while a positive voltage will turn the pass transistor on. For full on state it is recommended that  $V_{RAMP}$  be close to  $V_{DD}$ .  $V_{RAMP}$  can also be used to on-off key the amplifier for simple telemetry applications or as transmit/receive control.

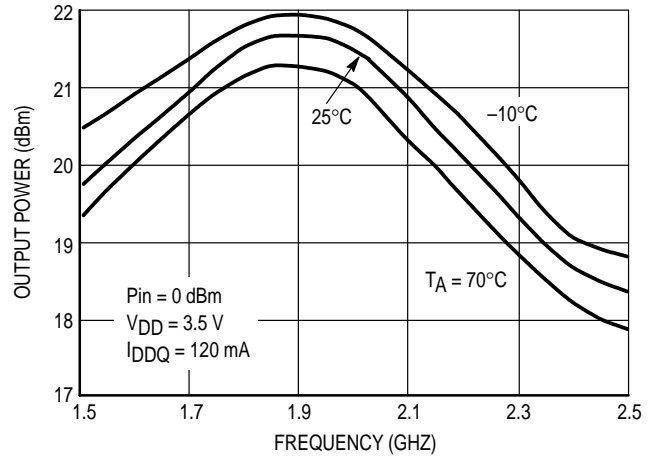
For more complex modulation schemes such as  $\pi/4$  DQPSK used in PHS, burst ramping can be implemented with the burst mode logic. Referring to Figure 3, the  $V_{RAMP}$  voltage should be set to  $V_{DD}$  to leave the pass transistor on. The on-chip pass transistor can also be bypassed and  $V_{DD}$  applied to Pins 11 and 14.

### EVALUATION BOARDS

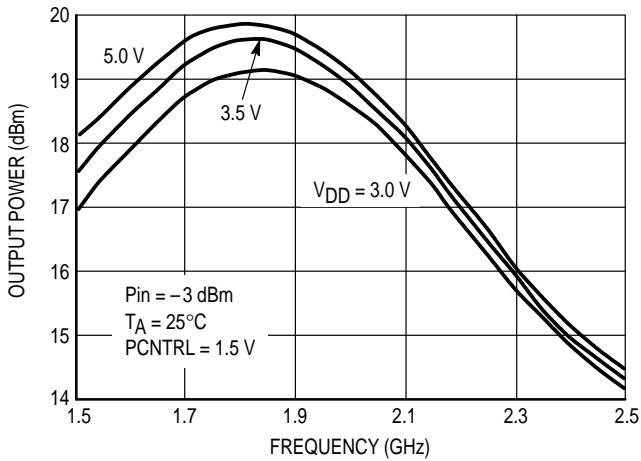
Evaluation boards are available for RF Monolithic Integrated Circuits by adding a "TF" suffix to the device type. For a complete list of currently available boards and ones in development for newly introduced product, please contact your local Motorola Distributor or Sales Office.



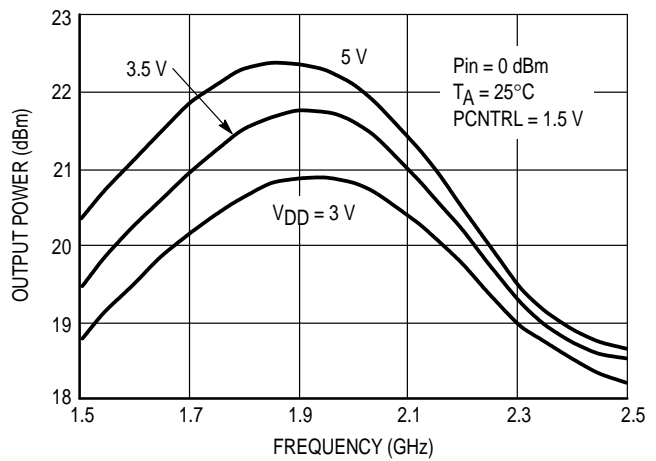
**Figure 4. Output Power versus Frequency With Internal Logic Translator**



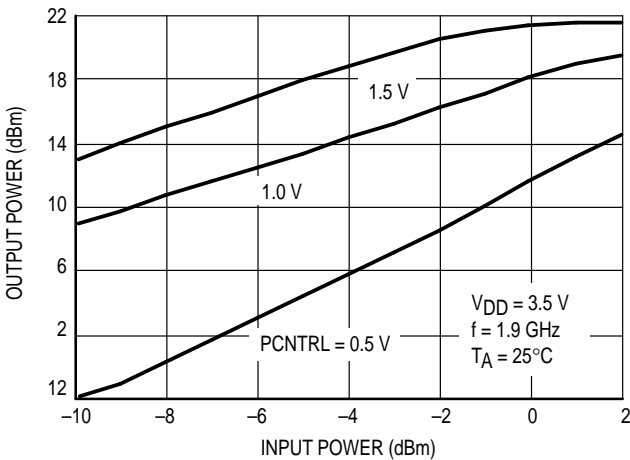
**Figure 5. Output Power versus Frequency Without Internal Logic Translator**



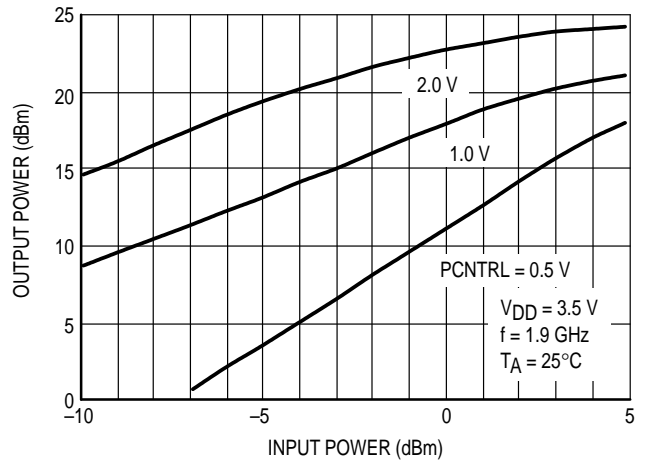
**Figure 6. Output Power versus Frequency With Internal Logic Translator**



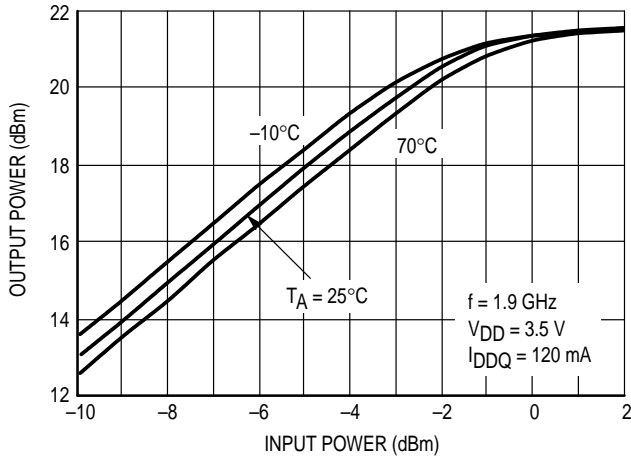
**Figure 7. Output Power versus Frequency Without Internal Logic Translator**



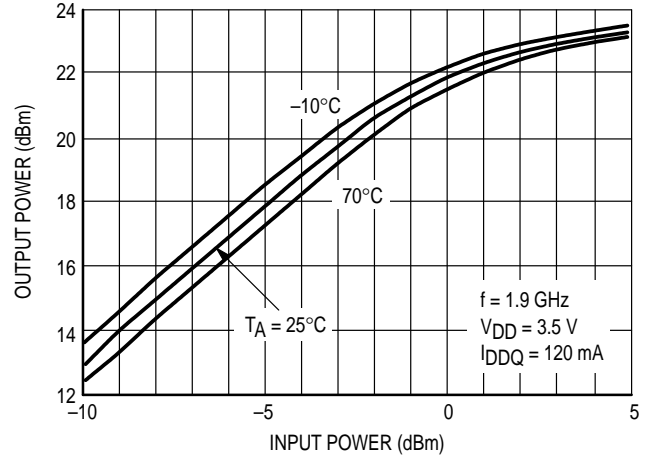
**Figure 8. Output Power versus Input Power With Internal Logic Translator**



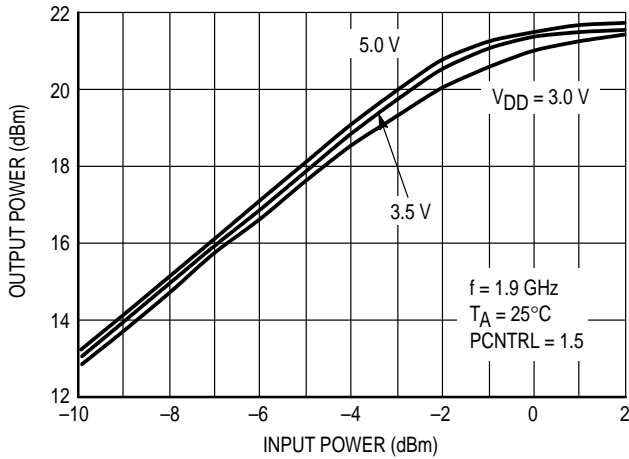
**Figure 9. Output Power versus Input Power Without Internal Logic Translator**



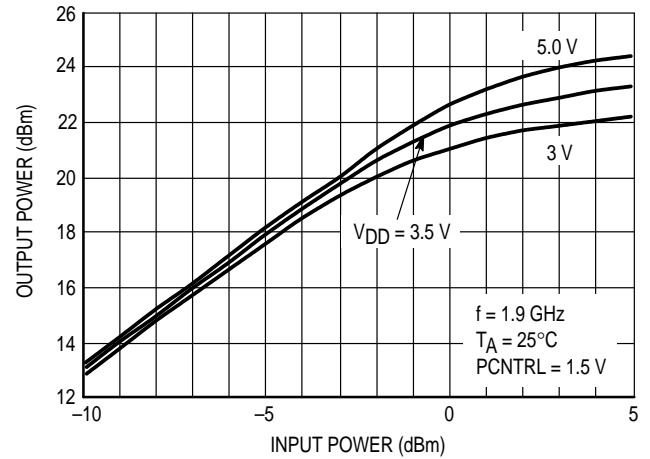
**Figure 10. Output Power versus Input Power With Internal Logic Translator**



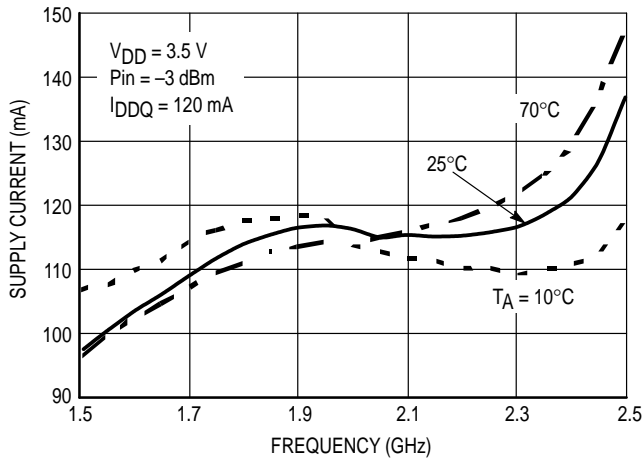
**Figure 11. Output Power versus Input Power Without Internal Logic Translator**



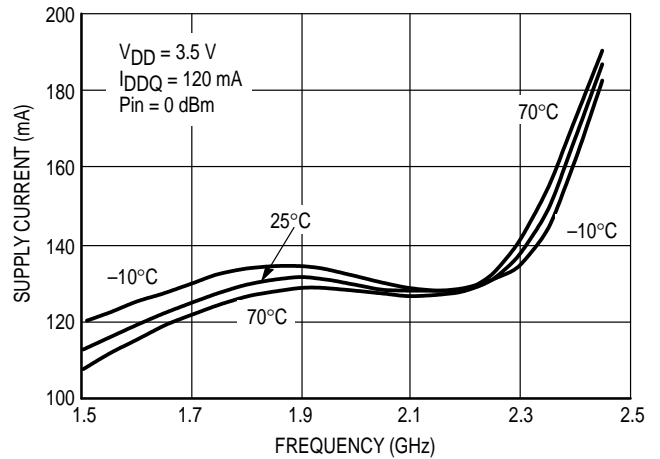
**Figure 12. Output Power versus Input Power With Internal Logic Translator**



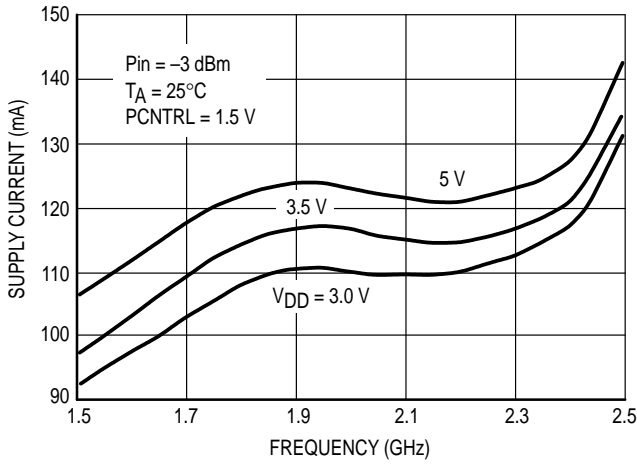
**Figure 13. Output Power versus Input Power Without Internal Logic Translator**



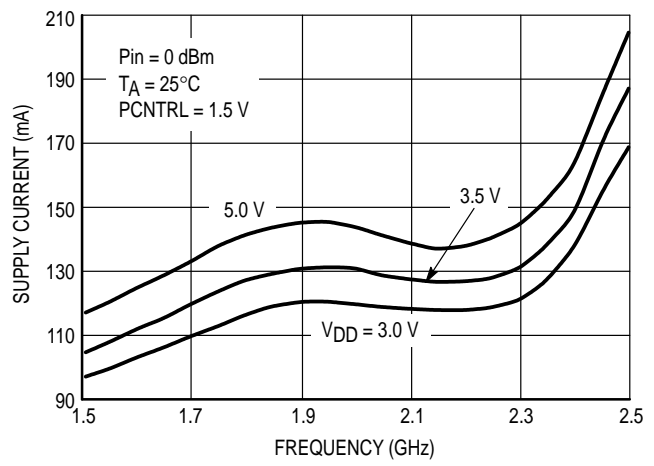
**Figure 14. Supply Current versus Frequency With Internal Logic Translator**



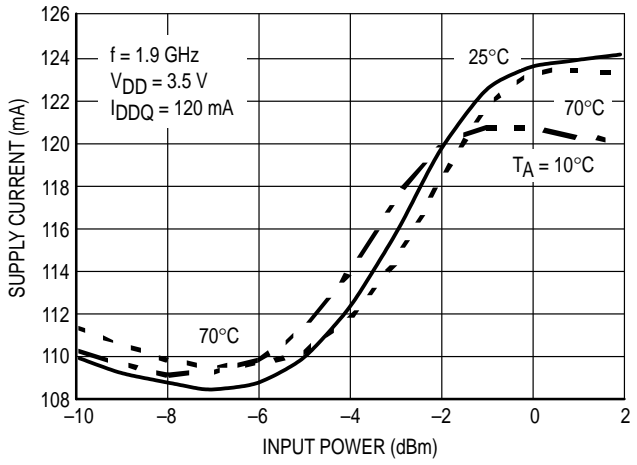
**Figure 15. Supply Current versus Frequency Without Internal Logic Translator**



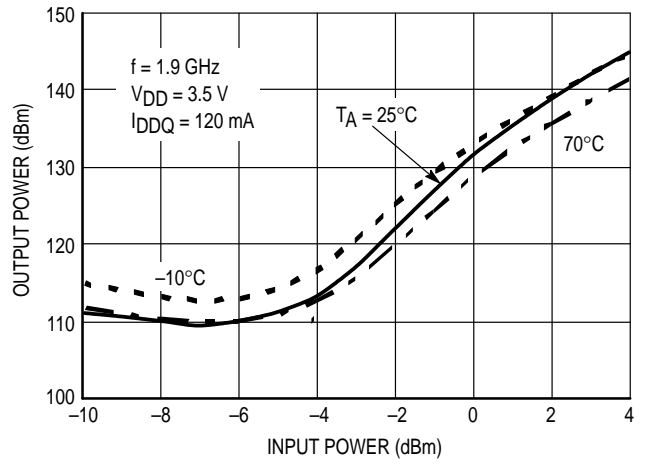
**Figure 16. Supply Current versus Frequency With Internal Logic Translator**



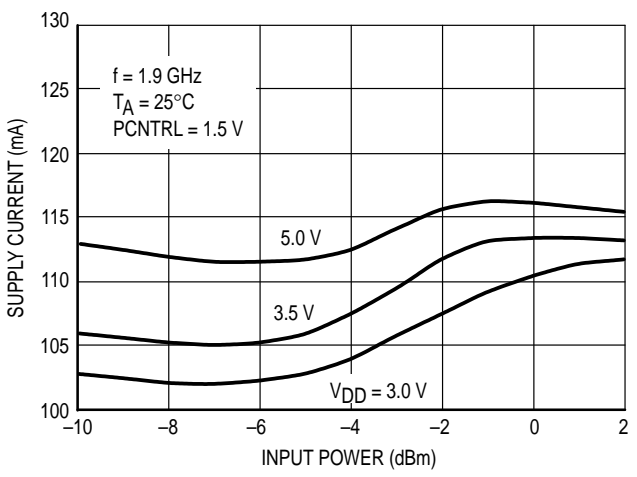
**Figure 17. Supply Current versus Frequency Without Internal Logic Translator**



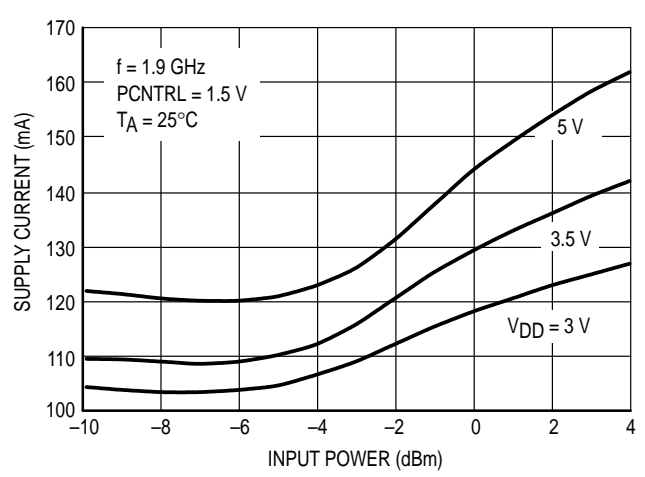
**Figure 18. Supply Current versus Input Power With Internal Translator**



**Figure 19. Supply Current versus Input Power Without Internal Translator**

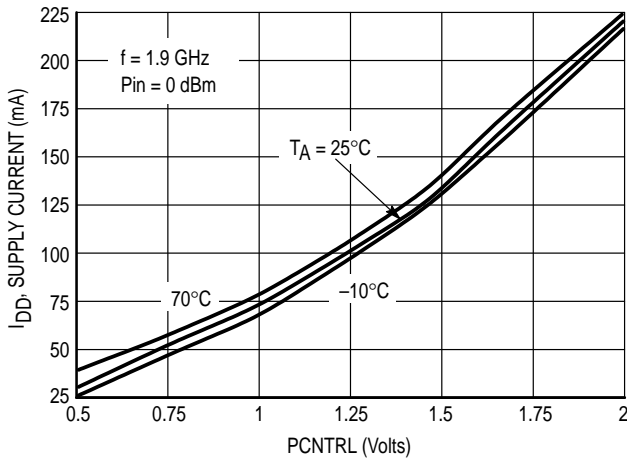


**Figure 20. Supply Current versus Input Power With Internal Translator**

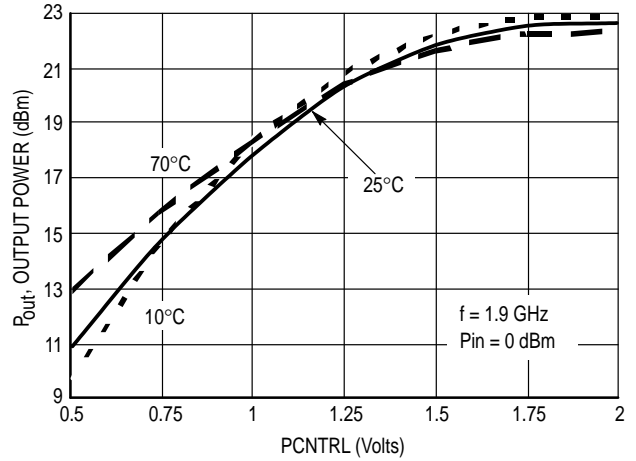


**Figure 21. Supply Current versus Input Power Without Internal Logic Translator**

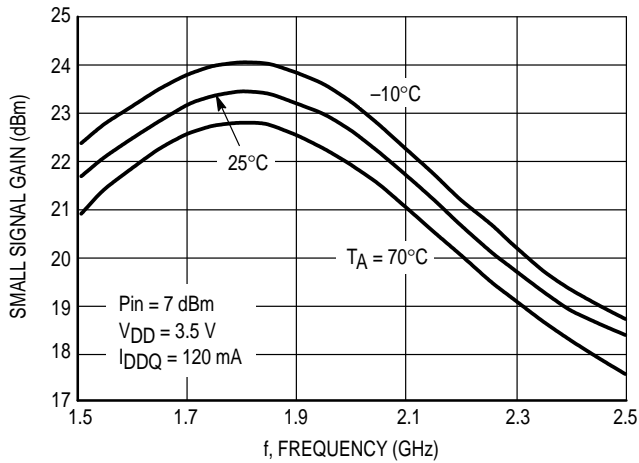




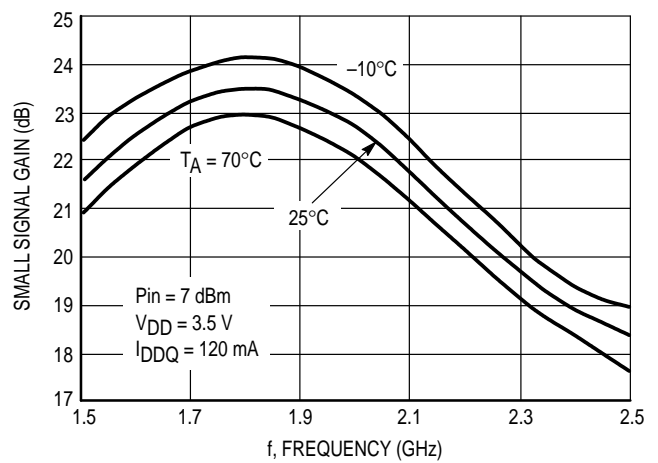
**Figure 22. Supply Current versus PCNTRL Without Internal Logic Translator**



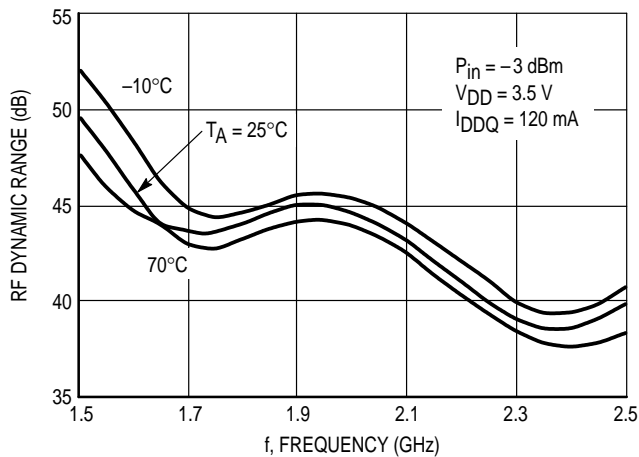
**Figure 23. P<sub>out</sub> versus PCNTRL Without Internal Logic Translator**



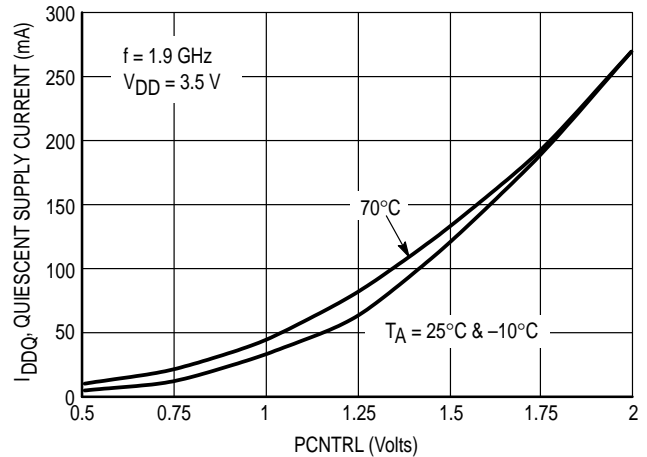
**Figure 24. Small Signal Gain versus Frequency With Internal Logic Translator**



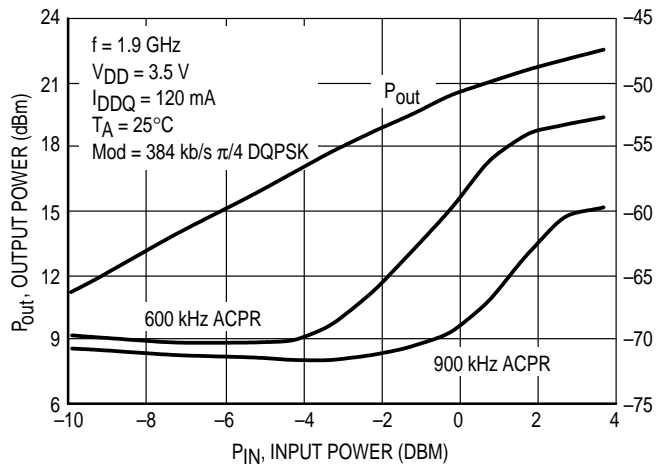
**Figure 25. Small signal Gain versus Frequency Without Internal Logic Translator**



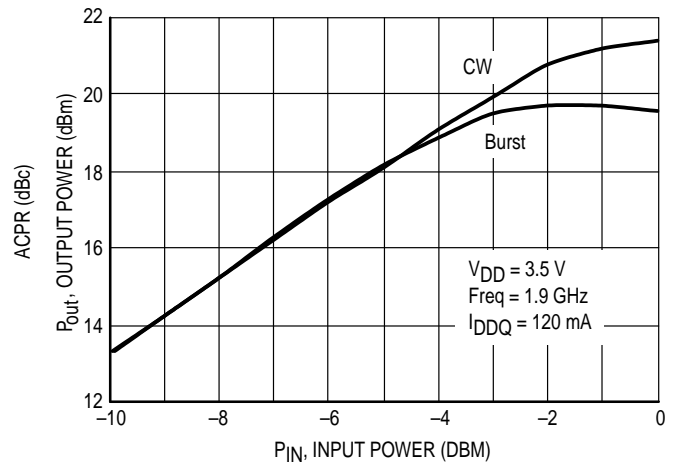
**Figure 26. Dynamic Range versus Frequency With Internal Logic Translator**



**Figure 27. Quiescent Supply Current versus PCNTRL With Internal Logic Translator**

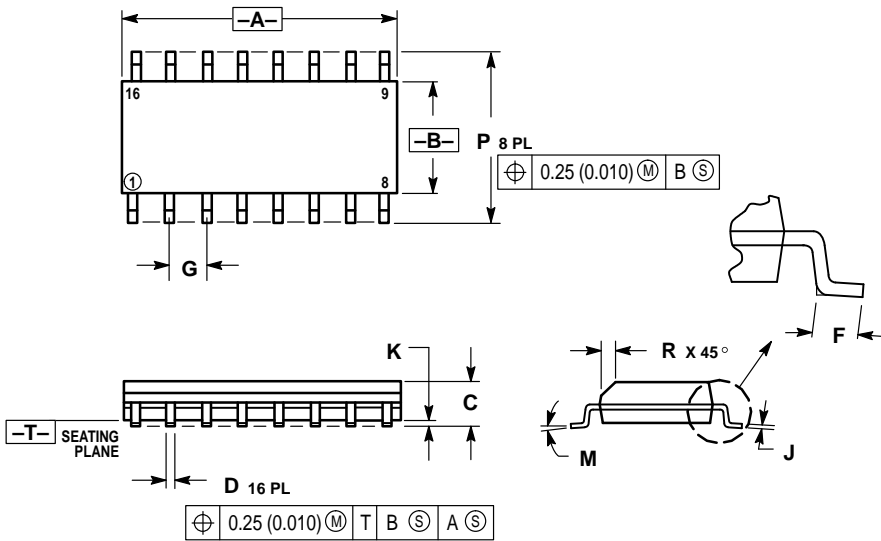


**Figure 28. Output Power and Adjacent Channel Power Ratio versus Input Power Without Internal Logic Translator**



**Figure 29. Continuous and Burst Mode Output Power versus Input Power With Internal Logic Translator**


# PACKAGE DIMENSIONS



- NOTES:
1. DIMENSIONING AND TOLERANCING PER ANSI Y14.5M, 1982.
  2. CONTROLLING DIMENSION: MILLIMETER.
  3. DIMENSIONS A AND B DO NOT INCLUDE MOLD PROTRUSION.
  4. MAXIMUM MOLD PROTRUSION 0.15 (0.006) PER SIDE.
  5. DIMENSION D DOES NOT INCLUDE DAMBAR PROTRUSION. ALLOWABLE DAMBAR PROTRUSION SHALL BE 0.127 (0.005) TOTAL IN EXCESS OF THE D DIMENSION AT MAXIMUM MATERIAL CONDITION.

DIM	MILLIMETERS		INCHES	
	MIN	MAX	MIN	MAX
A	9.80	10.00	0.386	0.393
B	3.80	4.00	0.150	0.157
C	1.35	1.75	0.054	0.068
D	0.35	0.49	0.014	0.019
F	0.40	1.25	0.016	0.049
G	1.27 BSC		0.050 BSC	
J	0.19	0.25	0.008	0.009
K	0.10	0.25	0.004	0.009
M	0°	7°	0°	7°
P	5.80	6.20	0.229	0.244
R	0.25	0.50	0.010	0.019

CASE 751B-05  
ISSUE J

Motorola reserves the right to make changes without further notice to any products herein. Motorola makes no warranty, representation or guarantee regarding the suitability of its products for any particular purpose, nor does Motorola assume any liability arising out of the application or use of any product or circuit, and specifically disclaims any and all liability, including without limitation consequential or incidental damages. "Typical" parameters which may be provided in Motorola data sheets and/or specifications can and do vary in different applications and actual performance may vary over time. All operating parameters, including "Typicals" must be validated for each customer application by customer's technical experts. Motorola does not convey any license under its patent rights nor the rights of others. Motorola products are not designed, intended, or authorized for use as components in systems intended for surgical implant into the body, or other applications intended to support or sustain life, or for any other application in which the failure of the Motorola product could create a situation where personal injury or death may occur. Should Buyer purchase or use Motorola products for any such unintended or unauthorized application, Buyer shall indemnify and hold Motorola and its officers, employees, subsidiaries, affiliates, and distributors harmless against all claims, costs, damages, and expenses, and reasonable attorney fees arising out of, directly or indirectly, any claim of personal injury or death associated with such unintended or unauthorized use, even if such claim alleges that Motorola was negligent regarding the design or manufacture of the part. Motorola and  are registered trademarks of Motorola, Inc. Motorola, Inc. is an Equal Opportunity/Affirmative Action Employer.

Mfax is a trademark of Motorola, Inc.

**How to reach us:**

**USA/EUROPE/Locations Not Listed:** Motorola Literature Distribution;  
P.O. Box 5405, Denver, Colorado 80217. 303-675-2140 or 1-800-441-2447

**JAPAN:** Nippon Motorola Ltd.: SPD, Strategic Planning Office, 4-32-1,  
Nishi-Gotanda, Shinagawa-ku, Tokyo 141, Japan. 81-3-5487-8488

**Mfax™:** RMFAX0@email.sps.mot.com – TOUCHTONE 602-244-6609  
– US & Canada ONLY 1-800-774-1848

**ASIA/PACIFIC:** Motorola Semiconductors H.K. Ltd.; 8B Tai Ping Industrial Park,  
51 Ting Kok Road, Tai Po, N.T., Hong Kong. 852-26629298

**INTERNET:** <http://motorola.com/sps>



**MRFIC1806/D**