

The RF Line Microwave Power Transistors

Designed primarily for large-signal output and driver amplifier stages in the 1.0 to 2.3 GHz frequency range.

- Designed for Class B or C, Common Base Power Amplifiers
- Specified 28 Volt, 2.0 GHz Characteristics:
 - Output Power — 1.0 to 20 Watts
 - Power Gain — 5.2 to 9.0 dB, Min
 - Collector Efficiency — 40%, Min
- Gold Metallization for Improved Reliability
- Diffused Ballast Resistors
- Circuit board photomaster available upon request by contacting RF Tactical Marketing in Phoenix, AZ.

MRW2001
MRW2003

5.2–9.0 dB
1.0–2.3 GHz
1.0 – 20 W
MICROWAVE
POWER TRANSISTORS

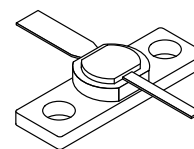

CASE 328A-03, STYLE 1
(GP-13)

MAXIMUM RATINGS

Rating	Symbol	Value	Unit
Collector–Base Voltage	V_{CES}	50	Vdc
Emitter–Base Voltage	V_{EBO}	3.5	Vdc
Collector Current — Continuous	I_C	0.25 0.5	Adc
		MRW2001 MRW2003	
Operating Junction Temperature	T_J	200	°C
Storage Temperature Range	T_{stg}	–65 to +200	°C

THERMAL CHARACTERISTICS

Characteristic	Symbol	Max	Unit
Thermal Resistance, RF, Junction to Case	$R_{\theta JC}$	25 15	°C/W
		MRW2001 MRW2003	

ELECTRICAL CHARACTERISTICS ($T_C = 25^\circ\text{C}$ unless otherwise noted)

Characteristic	Symbol	Min	Typ	Max	Unit
----------------	--------	-----	-----	-----	------

OFF CHARACTERISTICS

Collector–Emitter Breakdown Voltage	$V_{(BR)CES}$	50	—	—	Vdc
($I_C = 10\text{ mA}$, $V_{BE} = 0$)		MRW2001			
($I_C = 20\text{ mA}$, $V_{BE} = 0$)		MRW2003			

(continued)

ELECTRICAL CHARACTERISTICS — continued ($T_C = 25^\circ\text{C}$ unless otherwise noted)

Characteristic		Symbol	Min	Typ	Max	Unit
OFF CHARACTERISTICS (continued)						
Emitter–Base Breakdown Voltage ($I_E = 0.2\text{ mA}$, $I_C = 0$) ($I_E = 0.25\text{ mA}$, $I_C = 0$)	MRW2001	$V_{(BR)EBO}$	3.5	—	—	Vdc
	MRW2003		3.5	—	—	
Collector Cutoff Current ($V_{CB} = 28\text{ V}$, $I_E = 0$)	MRW2001 MRW2003	I_{CBO}	— —	— —	0.5 0.5	mAdc
ON CHARACTERISTICS						
DC Current Gain ($I_C = 100\text{ mA}$, $V_{CE} = 5.0\text{ V}$) ($I_C = 100\text{ mA}$, $V_{CE} = 5.0\text{ V}$)	MRW2001	h_{FE}	10	—	120	—
	MRW2003		10	—	100	
DYNAMIC CHARACTERISTICS						
Output Capacitance ($V_{CB} = 28\text{ V}$, $I_E = 0$, $f = 1.0\text{ MHz}$)	MRW2001 MRW2003	C_{ob}	— —	— —	4.0 5.0	pF
FUNCTIONAL TESTS						
Common–Base Amplifier Power Gain ($V_{CE} = 28\text{ V}$, $P_{out} = 1.0\text{ W}$, $f = 2.0\text{ GHz}$)	MRW2001	G_{PB}	9.0	—	—	dB
Common–Base Amplifier Power Gain ($V_{CE} = 28\text{ V}$, $P_{out} = 3.0\text{ W}$, $f = 2.0\text{ GHz}$)	MRW2003	G_{PB}	8.0	—	—	dB
Collector Efficiency ($V_{CE} = 28\text{ V}$, $P_{out} = 1.0\text{ W}$, $f = 2.0\text{ GHz}$) ($V_{CE} = 28\text{ V}$, $P_{out} = 3.0\text{ W}$, $f = 2.0\text{ GHz}$)	MRW2001	η	40	—	—	%
	MRW2003					
Load Mismatch ($V_{CE} = 28\text{ V}$, $f = 2.0\text{ GHz}$, Load $V_{SWR} = \infty:1$, All Phase Angles) $P_{out} = 1.0\text{ W}$ $P_{out} = 3.0\text{ W}$	MRW2001 MRW2003	ψ	No Degradation in Output Power			
Saturated Output Power ($V_{CE} = 28\text{ V}$, $f = 2.3\text{ GHz}$) ($V_{CE} = 28\text{ V}$, $f = 1.5\text{ GHz}$) ($V_{CE} = 28\text{ V}$, $f = 1.0\text{ GHz}$) ($V_{CE} = 28\text{ V}$, $f = 2.3\text{ GHz}$) ($V_{CE} = 28\text{ V}$, $f = 1.5\text{ GHz}$) ($V_{CE} = 28\text{ V}$, $f = 1.0\text{ GHz}$)	MRW2001	P_{sat1}	—	1.0	—	W
		P_{sat2}	—	1.2	—	
		P_{sat3}	—	1.3	—	
	MRW2003		—	3.0	—	
			—	3.7	—	
			—	4.0	—	

TYPICAL CHARACTERISTICS

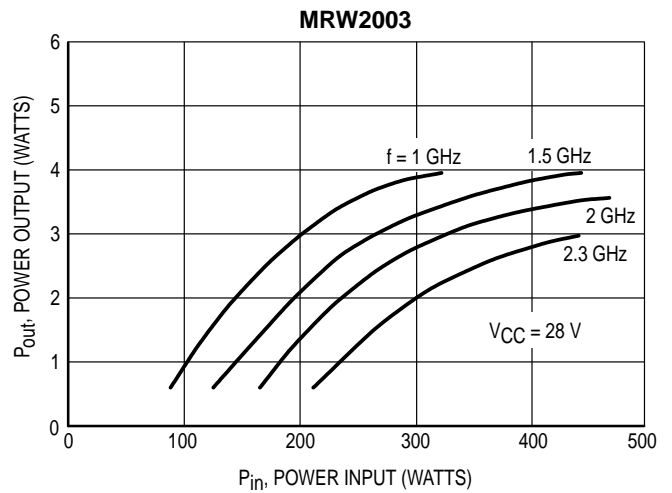
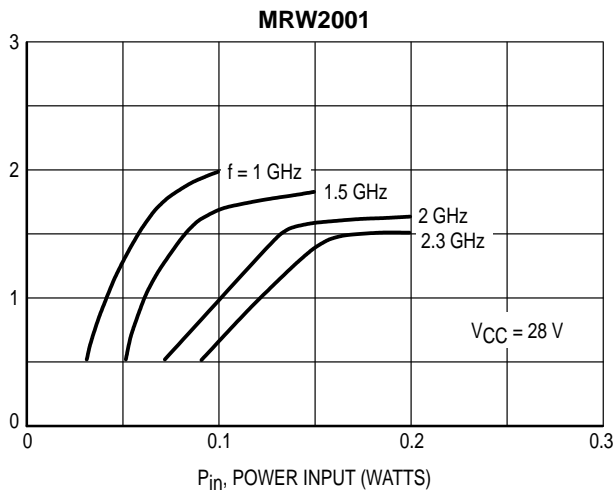

Figure 1. Output Power versus Input Power

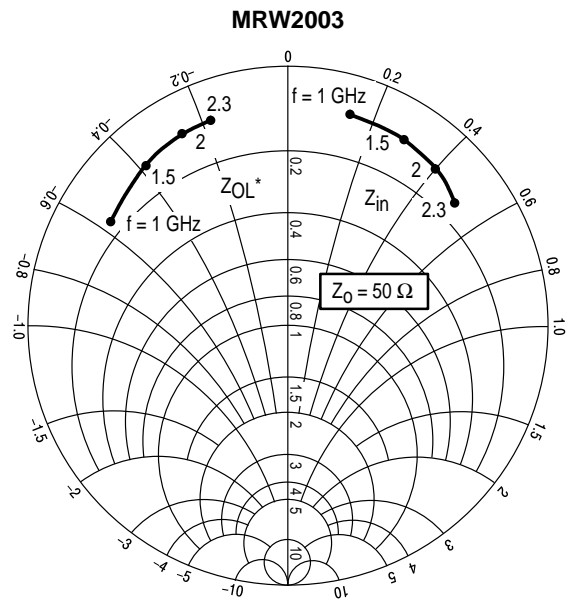
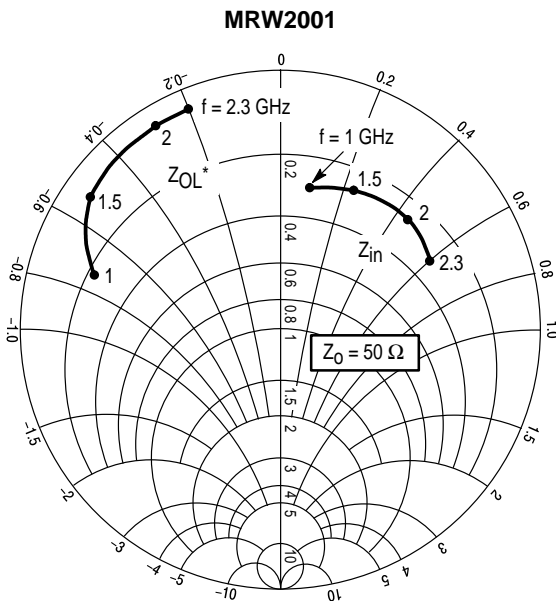

Figure 2. Series Equivalent Input/Output Impedance
 $V_{CC} = 28$ V

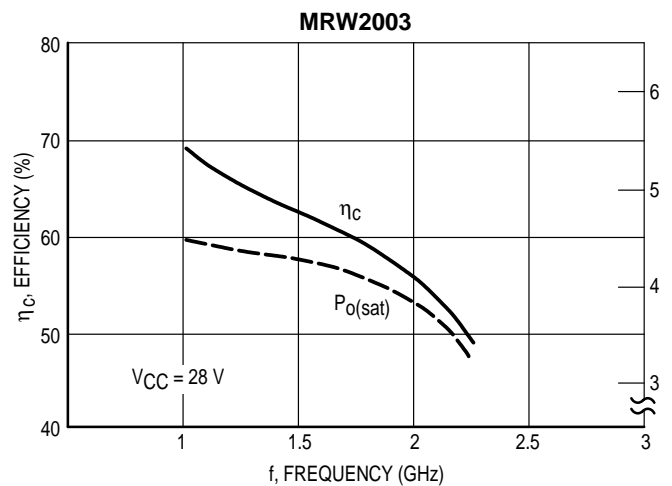
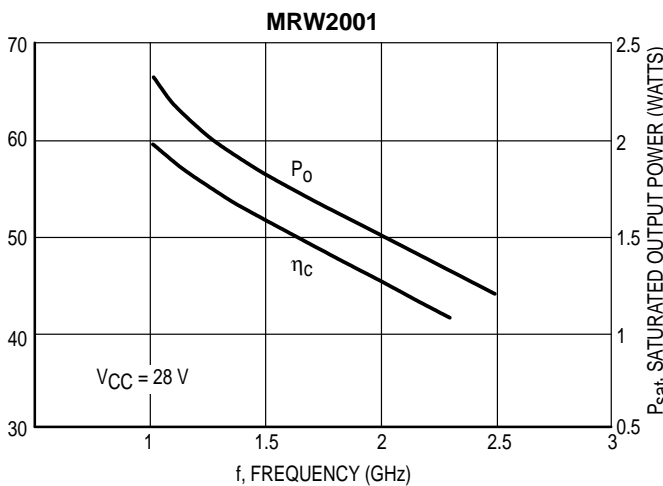

Figure 3. Power Output and Efficiency versus Frequency

The graph shown below displays MTTF in hours x ampere² emitter current for each of the "Super 2.0 GHz" devices. Life tests at elevated temperatures have correlated to better than $\pm 10\%$ to the theoretical prediction for metal failure. Sample MTTF calculations based on operating conditions are included on the graph.

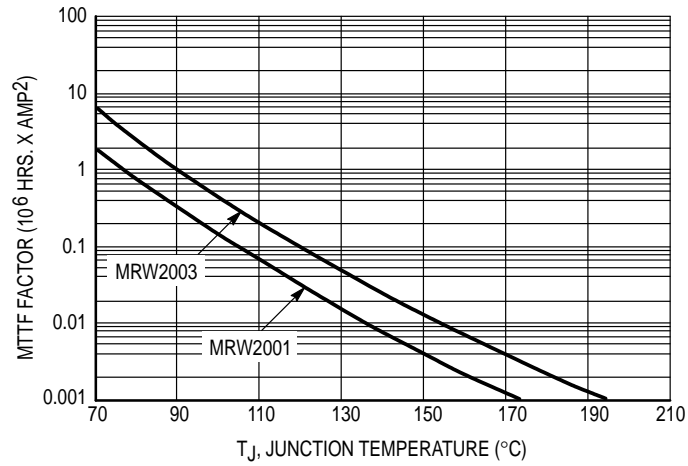

Figure 4. MTTF Factor

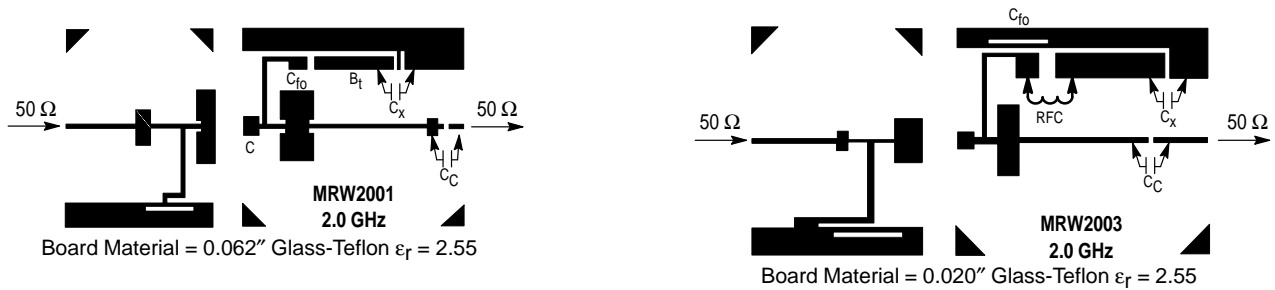
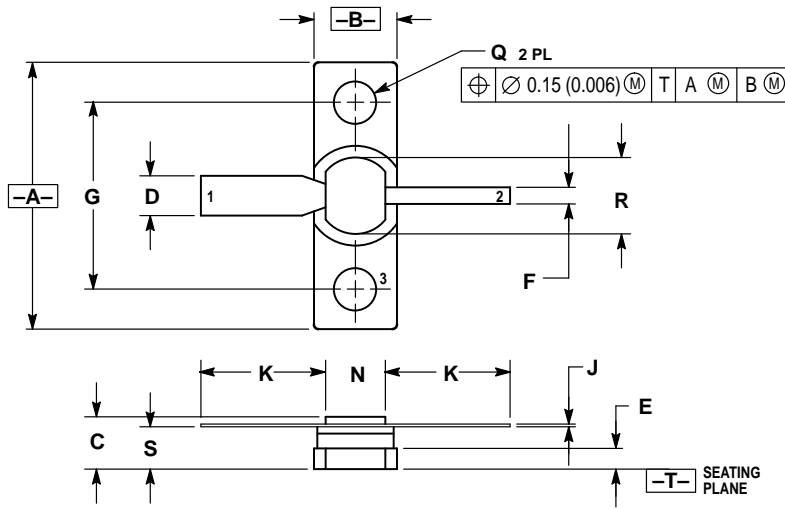

Figure 5. PC Board Layouts

PACKAGE DIMENSIONS



- NOTES:
 1. DIMENSIONING AND TOLERANCING PER ANSI Y14.5M, 1982.
 2. CONTROLLING DIMENSION: INCH.

DIM	INCHES		MILLIMETERS	
	MIN	MAX	MIN	MAX
A	0.795	0.805	20.20	20.45
B	0.245	0.255	6.23	6.47
C	0.145	0.170	3.69	4.31
D	0.115	0.125	2.93	3.17
E	0.055	0.065	1.40	1.65
F	0.045	0.055	1.15	1.39
G	0.562 BSC		14.27 BSC	
J	0.003	0.006	0.08	0.15
K	0.260	0.375	6.60	9.52
N	0.175	0.185	4.45	4.69
Q	0.120	0.135	3.05	3.42
R	0.225	0.235	5.72	5.97
S	0.120	0.130	3.05	3.30

- STYLE 1:
 1. EMITTER
 2. COLLECTOR
 3. BASE

**CASE 328A-03
 ISSUE E**

Motorola reserves the right to make changes without further notice to any products herein. Motorola makes no warranty, representation or guarantee regarding the suitability of its products for any particular purpose, nor does Motorola assume any liability arising out of the application or use of any product or circuit, and specifically disclaims any and all liability, including without limitation consequential or incidental damages. "Typical" parameters which may be provided in Motorola data sheets and/or specifications can and do vary in different applications and actual performance may vary over time. All operating parameters, including "Typicals" must be validated for each customer application by customer's technical experts. Motorola does not convey any license under its patent rights nor the rights of others. Motorola products are not designed, intended, or authorized for use as components in systems intended for surgical implant into the body, or other applications intended to support or sustain life, or for any other application in which the failure of the Motorola product could create a situation where personal injury or death may occur. Should Buyer purchase or use Motorola products for any such unintended or unauthorized application, Buyer shall indemnify and hold Motorola and its officers, employees, subsidiaries, affiliates, and distributors harmless against all claims, costs, damages, and expenses, and reasonable attorney fees arising out of, directly or indirectly, any claim of personal injury or death associated with such unintended or unauthorized use, even if such claim alleges that Motorola was negligent regarding the design or manufacture of the part. Motorola and  are registered trademarks of Motorola, Inc. Motorola, Inc. is an Equal Opportunity/Affirmative Action Employer.

Mfax is a trademark of Motorola, Inc.

How to reach us:

USA/EUROPE/Locations Not Listed: Motorola Literature Distribution;
P.O. Box 5405, Denver, Colorado 80217. 303-675-2140 or 1-800-441-2447

JAPAN: Nippon Motorola Ltd.: SPD, Strategic Planning Office, 4-32-1,
Nishi-Gotanda, Shinagawa-ku, Tokyo 141, Japan. 81-3-5487-8488

Mfax™: RMFAX0@email.sps.mot.com – TOUCHTONE 602-244-6609
– US & Canada ONLY 1-800-774-1848

ASIA/PACIFIC: Motorola Semiconductors H.K. Ltd.; 8B Tai Ping Industrial Park,
51 Ting Kok Road, Tai Po, N.T., Hong Kong. 852-26629298

INTERNET: <http://motorola.com/sps>



MOTOROLA



MRW2001/D