

RF & MICROWAVE TRANSISTORS GENERAL PURPOSE AMPLIFIER APPLICATIONS

PRELIMINARY DATA

- REFRACTORY/GOLD METALLIZATION
- VSWR CAPABILITY 20:1 @ RATED CONDITIONS
- HERMETIC STRIPAC® PACKAGE
- P_{OUT} = 3.8 W MIN. WITH 10.0 dB GAIN

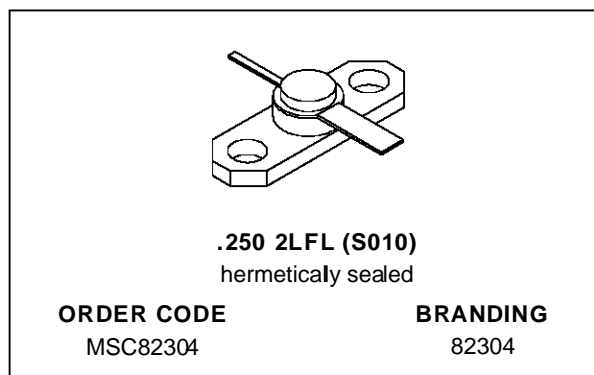

DESCRIPTION

The MSC82304 is a common base hermetically sealed silicon NPN microwave power transistor utilizing a rugged overlay die geometry. This device is capable of withstanding 20:1 load VSWR at any phase angle under rated conditions.

The MSC82304 was designed for Class C Amplifier/Oscillator applications in the 1.5 - 2.3 GHz frequency range.

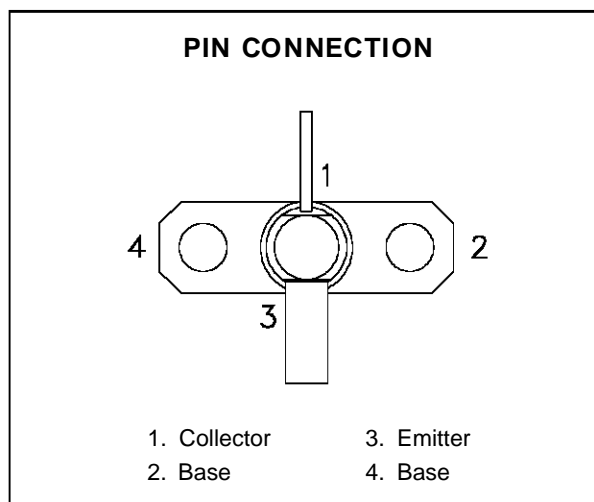

ABSOLUTE MAXIMUM RATINGS (T_{case} = 25°C)

Symbol	Parameter	Value	Unit
P _{DISS}	Power Dissipation* (T _c ≤ 50°C)	11.5	W
I _c	Device Current*	600	mA
V _{CC}	Collector-Supply Voltage*	26	V
T _J	Junction Temperature	200	°C
T _{STG}	Storage Temperature	- 65 to +200	°C

THERMAL DATA

R _{TH(j-c)}	Junction-Case Thermal Resistance*	13	°C/W
----------------------	-----------------------------------	----	------

*Applies only to rated RF amplifier operation

MSC82304

ELECTRICAL SPECIFICATIONS ($T_{\text{case}} = 25^{\circ}\text{C}$)

STATIC

Symbol	Test Conditions			Value			Unit
				Min.	Typ.	Max.	
BV_{CBO}	$I_{\text{C}} = 1\text{mA}$	$I_{\text{E}} = 0\text{mA}$	44	—	—	V	
BV_{EBO}	$I_{\text{E}} = 1\text{mA}$	$I_{\text{C}} = 0\text{mA}$	3.5	—	—	V	
BV_{CER}	$I_{\text{C}} = 5\text{mA}$	$R_{\text{BE}} = 10\Omega$	44	—	—	V	
I_{CBO}	$V_{\text{CB}} = 22\text{V}$		—	—	0.5	mA	
h_{FE}	$V_{\text{CE}} = 5\text{V}$	$I_{\text{C}} = 250\text{mA}$	30	—	300	—	

DYNAMIC

Symbol	Test Conditions			Value			Unit
				Min.	Typ.	Max.	
P_{OUT}	$f = 2.3\text{ GHz}$	$P_{\text{IN}} = 0.38\text{ W}$	$V_{\text{CC}} = 22\text{ V}$	3.8	—	—	W
η_{C}	$f = 2.3\text{ GHz}$	$P_{\text{IN}} = 0.38\text{ W}$	$V_{\text{CC}} = 22\text{ V}$	40	—	—	%
G_{P}	$f = 2.3\text{ GHz}$	$P_{\text{IN}} = 0.38\text{ W}$	$V_{\text{CC}} = 22\text{ V}$	10.0	—	—	dB
C_{OB}	$f = 1\text{ MHz}$	$V_{\text{CB}} = 22\text{ V}$		—	—	5.0	pF

IMPEDANCE DATA

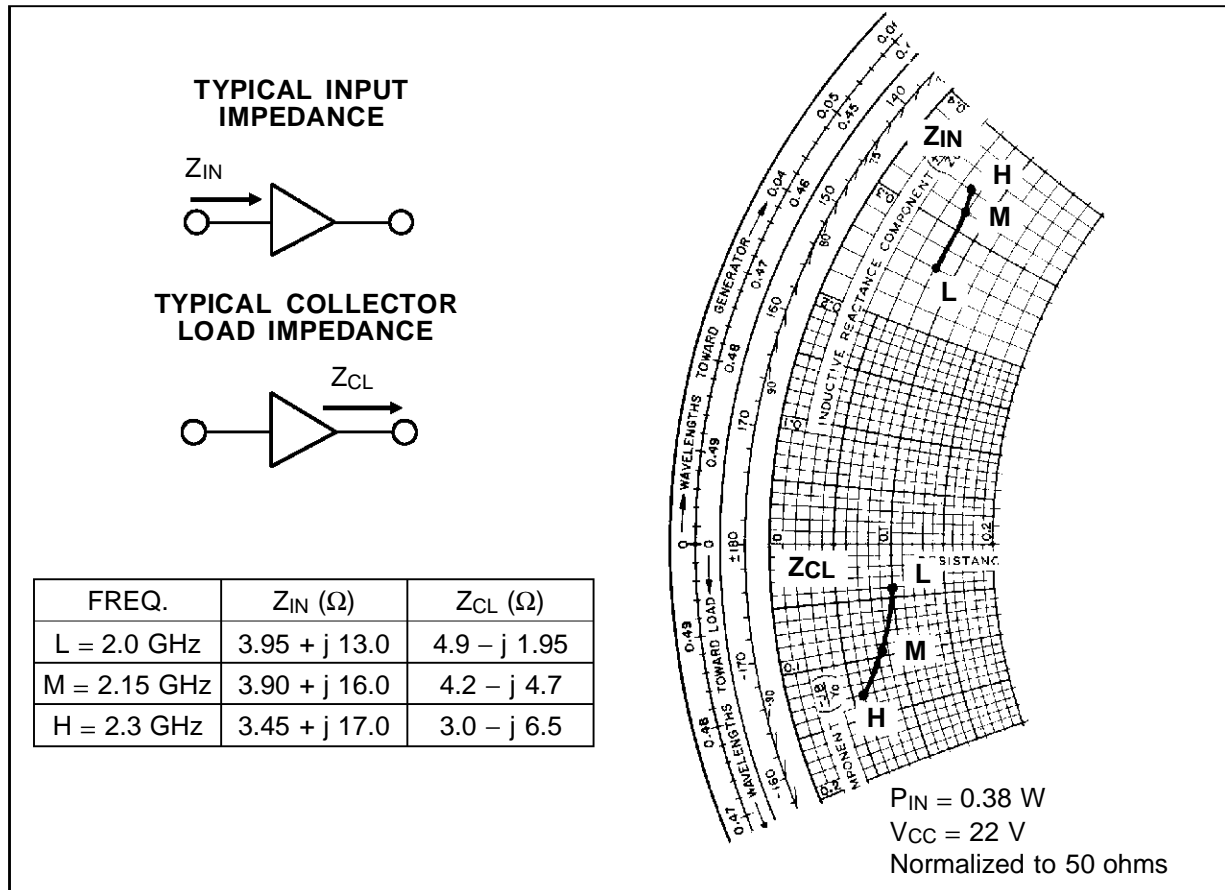

TEST CIRCUIT

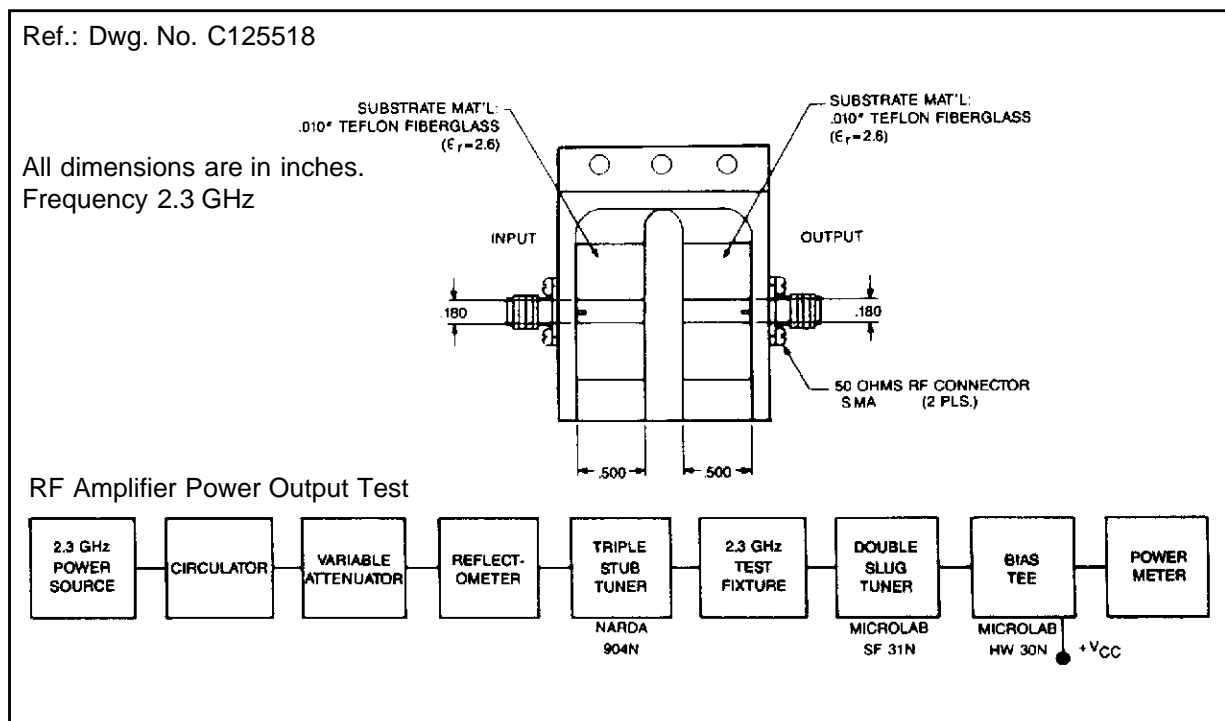

PACKAGE MECHANICAL DATA

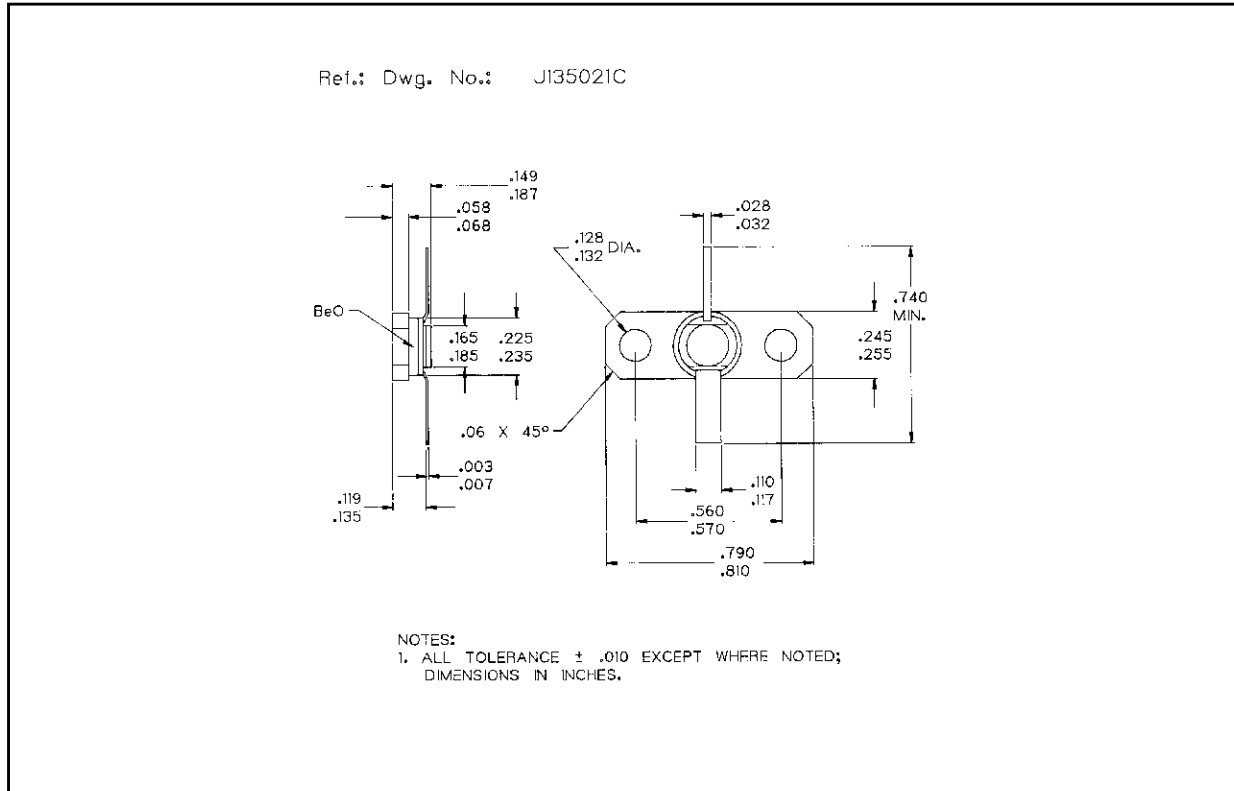

Information furnished is believed to be accurate and reliable. However, SGS-THOMSON Microelectronics assumes no responsibility for the consequences of use of such information nor for any infringement of patents or other rights of third parties which may results from its use. No license is granted by implication or otherwise under any patent or patent rights of SGS-THOMSON Microelectronics. Specifications mentioned in this publication are subject to change without notice. This publication supersedes and replaces all information previously supplied. SGS-THOMSON Microelectronics products are not authorized for use as critical components in life support devices or systems without express written approval of SGS-THOMSON Microelectronics.

© 1994 SGS-THOMSON Microelectronics - All Rights Reserved

SGS-THOMSON Microelectronics GROUP OF COMPANIES
Australia - Brazil - France - Germany - Hong Kong - Italy - Japan - Korea - Malaysia - Malta - Morocco - The Netherlands -
Singapore - Spain - Sweden - Switzerland - Taiwan - Thailand - United Kingdom - U.S.A