



M.S.KENNEDY CORP.

**DUAL POSITIVE/NEGATIVE,  
3 AMP, LOW DROPOUT  
FIXED VOLTAGE REGULATORS**

**5000  
SERIES**

4707 Dey Road Liverpool, N.Y. 13088

(315) 701-6751

**FEATURES:**

- Dual Low Dropout Voltage
- Internal Short Circuit Current Limit
- Output Voltages Are Internally Set To  $\pm 1\%$  Max
- Electrically Isolated Case
- Internal Thermal Overload Protection
- Many Output Voltage Combinations
- Available Fully Qualified to Mil-PRF-38534
- Alternate Package and Lead Form Configurations Available

**MIL-PRF-38534 CERTIFIED**

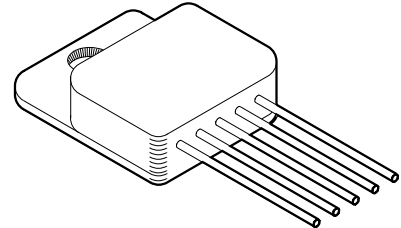

**DESCRIPTION:**

The MSK 5000 Series offers low dropout voltages on both the positive and negative regulators. This, combined with the low  $\theta_{JC}$ , allows increased output current while providing exceptional device efficiency. Because of the increased efficiency, a small hermetic 5 pin package can be used providing maximum performance while occupying minimal board space. Output voltages are internally trimmed to  $\pm 1\%$  maximum resulting in consistent and accurate operation. Additionally, both regulators offer internal short circuit current and thermal limiting, which allows circuit protection and eliminates the need for external components and excessive derating.

**EQUIVALENT SCHEMATIC**

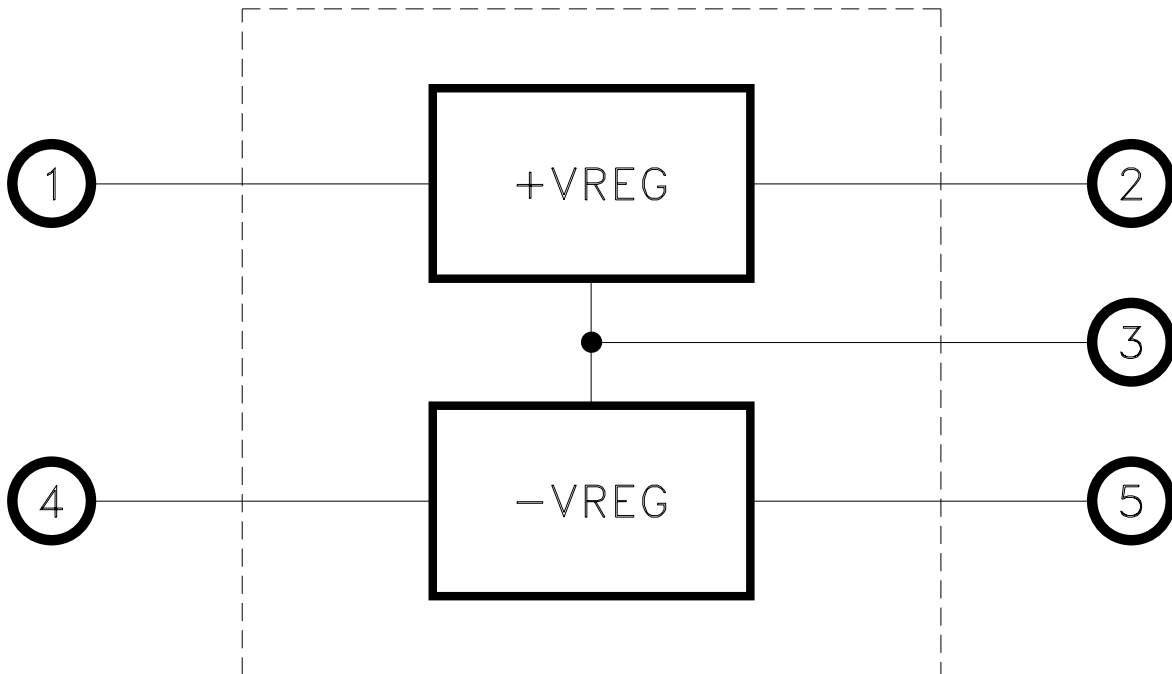

**TYPICAL APPLICATIONS**

- High Efficiency Linear Regulators
- Constant Voltage/Current Regulators
- System Power Supplies
- Switching Power Supply Post Regulators

**PIN-OUT INFORMATION**

- 1 +Vin
- 2 +Vout
- 3 GND
- 4 -Vin
- 5 -Vout

## ABSOLUTE MAXIMUM RATINGS

$\pm V_{IN}$	Input Voltage (WRT $V_{OUT}$ ) . . . . . $\pm 30V$	$T_{ST}$	Storage Temperature Range	-65°C to +150°C
$P_D$	Power Dissipation . . . . . Internally Limited	$T_{LD}$	Lead Temperature Range . . . . .	300°C
$I_{OUT}$	Output Current . . . . . $\pm 3A$		(10 Seconds)	
$T_J$	Junction Temperature . . . . . +175°C	$T_C$	Case Operating Temperature	
			MSK 5000-5009 . . . . .	-40°C to +85°C
			MSK 5000B-5009B . . . . .	-55°C to +125°C

## ELECTRICAL SPECIFICATIONS

Parameter	Test Conditions ③	Group A Subgroup	MSK 5000(B) SERIES			MSK 5000 SERIES			Units
			Min.	Typ.	Max.	Min.	Typ.	Max.	
<b>POSITIVE OUTPUT REGULATORS:</b>									
Output Voltage Tolerance	$I_{OUT} = 0A$ ; $V_{IN} = V_{OUT} + 3V$	1	-	0.1	1.0	-	0.1	2.0	%
		2,3	-	0.1	2.0	-	-	-	%
Dropout Voltage ②	$0A \leq I_{OUT} \leq 3A$ ; $\Delta V_{OUT} = 50mV$	1	-	1.3	1.5	-	1.3	1.6	V
Load Regulation	$100mA \leq I_{OUT} \leq 3A$ $V_{IN} = V_{OUT} + 3V$	1	-	0.2	1	-	0.2	2	%
		2,3	-	0.3	2	-	-	-	%
Line Regulation	$I_{OUT} = 0A$ $(V_{OUT} + 3V) \leq V_{IN} \leq (V_{OUT} + 15V)$	1	-	0.1	0.5	-	0.1	0.6	%
		2,3	-	0.2	.75	-	-	-	%
Quiescent Current	$V_{IN} = V_{OUT} + 3V$ ; $I_{OUT} = 0A$	1,2,3	-	10	15	-	10	15	mA
Short Circuit Current ②	$V_{IN} = V_{OUT} + 5V$	-	3.2	4	-	3.0	4	-	A
Ripple Rejection ②	$I_{OUT} = 3A$ ; $C_{OUT} = 25\mu F$ ; $f = 120Hz$	-	60	75	-	60	75	-	dB
Thermal Resistance ②	JUNCTION TO CASE	-	-	2.5	2.7	-	2.5	2.7	°C/W
<b>NEGATIVE OUTPUT REGULATORS: ⑧</b>									
Output Voltage Tolerance	$I_{OUT} = 0A$ ; $V_{IN} = V_{OUT} + 3V$	1	-	0.1	1.0	-	0.1	2.0	%
		2,3	-	0.1	2.0	-	-	-	%
Dropout Voltage	$0A \leq I_{OUT} \leq 3A$ ; $\Delta V_{OUT} = 50mV$	1	-	0.8	1.2	-	0.8	1.3	V
Load Regulation	$V_{IN} = V_{OUT} + 3V$ $100mA \leq I_{OUT} \leq 3A$	1	-	0.2	1	-	0.2	2	%
		2,3	-	0.3	2	-	-	-	%
Line Regulation	$I_{OUT} = 0A$ $(V_{OUT} + 3V) \leq V_{IN} \leq (V_{OUT} + 15V)$	1	-	.1	.5	-	.1	.6	%
		2,3	-	.2	.75	-	-	-	%
Quiescent Current	$V_{IN} = V_{OUT} + 3V$ ; $I_{OUT} = 0A$	1,2,3	-	4.5	10	-	4.5	10	mA
Short Circuit Current ②	$V_{IN} = V_{OUT} + 5V$	-	3.3	3.6	-	3.0	3.6	-	A
Ripple Rejection ②	$I_{OUT} = 3A$ ; $C_{OUT} = 25\mu F$ ; $f = 120Hz$	-	60	75	-	60	75	-	dB
Thermal Resistance ②	JUNCTION TO CASE	-	-	2.0	2.2	-	2.0	2.2	°C/W

PART ⑦ NUMBER	OUTPUT VOLTAGES	
	POSITIVE	NEGATIVE
MSK5000(B)	+ 3.3V	-5.2V
MSK5001(B)	+ 5.0V	-5.0V
MSK5002(B)	+ 5.0V	-5.2V
MSK5003(B)	+ 12.0V	-5.0V
MSK5004(B)	+ 12.0V	-12.0V
MSK5005(B)	+ 15.0V	-15.0V
MSK5006(B)	+ 15.0V	-5.0V
MSK5007(B)	+ 5.0V	-12.0V
MSK5008(B)	+ 5.0V	-15.0V
MSK5009(B)	+ 10.0V	-10.0V

- ① Outputs are decoupled to ground using 10 $\mu F$  minimum low ESR capacitors unless otherwise specified.
- ② This parameter is guaranteed by design but need not be tested. Typical parameters are representative of actual device performance but are for reference only.
- ③ All output parameters are tested using a low duty cycle pulse to maintain  $T_J = T_C$ .
- ④ Industrial grade devices shall be tested to subgroup 1 unless otherwise specified.
- ⑤ Military grade devices ('B' suffix) shall be 100% tested to subgroups 1,2 and 3.
- ⑥ Subgroup 1  $T_A = T_C = +25^\circ C$   
Subgroup 2  $T_A = T_C = +125^\circ C$   
Subgroup 3  $T_A = T_C = -55^\circ C$
- ⑦ Please consult the factory if alternate output voltages are required.
- ⑧ Input voltage ( $V_{IN} = V_{OUT} +$  a specified voltage) is implied to be more negative than  $V_{OUT}$ .

## APPLICATION NOTES

### BYPASS CAPACITORS

For most applications a 10uF minimum, low ESR (0.5-2 ohm) tantalum capacitor should be attached as close to the regulator's output as possible. This will effectively lower the regulator's output impedance, increase transient response and eliminate any oscillations that are normally associated with low dropout regulators. Additional bypass capacitors can be used at the remote load locations to further improve regulation. These can be either of the tantalum or the electrolytic variety. Unless the regulator is located very close to the power supply filter capacitor(s), a 4.7uF minimum low ESR (0.5-2 ohm) tantalum capacitor should also be added to the regulator's input. An electrolytic may also be substituted if desired. When substituting electrolytic in place of tantalum capacitors, a good rule of thumb to follow is to increase the size of the electrolytic by a factor of 10 over the tantalum value.

### LOAD REGULATION

For best results the ground pin should be connected directly to the load as shown below, this effectively reduces the ground loop effect and eliminates excessive voltage drop in the sense leg. It is also important to keep the output connection between the regulator and the load as short as possible since this directly affects the load regulation. For example, if 20 gauge wire were used which has a resistance of about .008 ohms per foot, this would result in a drop of 8mV/ft at 1Amp of load current. It is also important to follow the capacitor selection guidelines to achieve best performance. Refer to Figure 2 for connection diagram.

### MSK 5002 TYPICAL APPLICATION:

#### Low Dropout Positive and Negative Power Supply

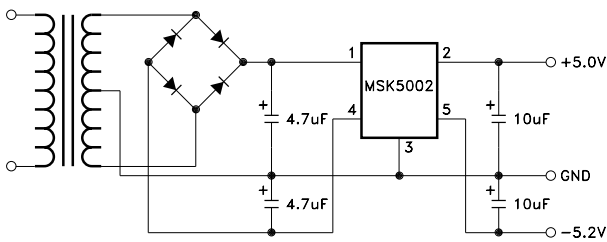

FIGURE 1

#### Avoiding Ground Loops

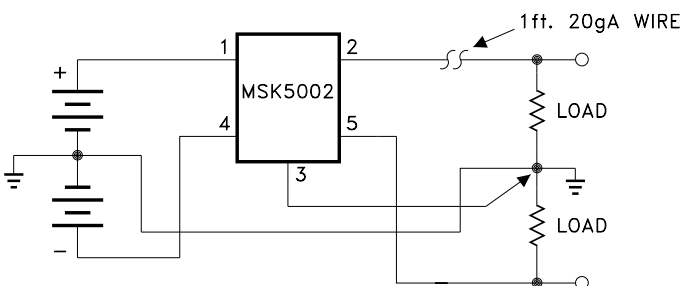

FIGURE 2

### OVERLOAD SHUTDOWN

The regulators feature both power and thermal overload protection. When the maximum power dissipation is not exceeded, the regulators will current limit slightly above their 3 amp rating. As the  $V_{in}-V_{out}$  voltage increases, however, shutdown occurs in relation to the maximum power dissipation curve. If the device heats enough to exceed its rated die junction temperature due to excessive ambient temperature, improper heat sinking etc., the regulators also shutdown until an appropriate junction temperature is maintained. It should also be noted that in the case of an extreme overload, such as a sustained direct short, the device may not be able to recover. In these instances, the device must be shut off and power reapplied to eliminate the shutdown condition.

### HEAT SINKING

To determine if a heat sink is required for your application and if so, what type, refer to the thermal model and governing equation below.

Governing Equation:  $T_j = P_d \times (R_{\theta jc} + R_{\theta cs} + R_{\theta sa}) + T_a$

#### WHERE

$T_j$  = Junction Temperature  
 $P_d$  = Total Power Dissipation  
 $R_{\theta jc}$  = Junction to Case Thermal Resistance  
 $R_{\theta cs}$  = Case to Heat Sink Thermal Resistance  
 $R_{\theta sa}$  = Heat Sink to Ambient Thermal Resistance  
 $T_c$  = Case Temperature  
 $T_a$  = Ambient Temperature  
 $T_s$  = Heat Sink Temperature

#### EXAMPLE:

This example demonstrates an analysis where each regulator is at one-half of its maximum rated power dissipation, which occurs when the output currents are at 1.5 amps each.

Conditions for MSK 5002:

$V_{in} = \pm 7.0V$ ;  $I_{out} = \pm 1.5A$

- 1.) Assume 45° heat spreading model.
- 2.) Find positive regulator power dissipation:

$$\begin{aligned} P_d &= (V_{in} - V_{out})(I_{out}) \\ P_d &= (7-5)(1.5) \\ &= 3.0W \end{aligned}$$

- 3.) For conservative design, set  $T_j = +125^\circ C$  Max.
- 4.) For this example, worst case  $T_a = +90^\circ C$ .
- 5.)  $R_{\theta jc} = 2.5^\circ C/W$  from the Electrical Specification Table.
- 6.)  $R_{\theta cs} = 0.15^\circ C/W$  for most thermal greases.
- 7.) Rearrange governing equation to solve for  $R_{\theta sa}$ :

$$\begin{aligned} R_{\theta sa} &= ((T_j - T_a)/P_d) - (R_{\theta jc}) - (R_{\theta cs}) \\ &= (125^\circ C - 90^\circ C)/3.0W - (2.5^\circ C/W - 0.15^\circ C/W) \\ &= 9.32^\circ C/W \end{aligned}$$

The same exercise must be performed for the negative regulator. In this case the result is  $9.32^\circ C/W$ . Therefore, a heat sink with a thermal resistance of no more than  $9.3^\circ C/W$  must be used in this application to maintain both regulator circuit junction temperatures under  $125^\circ C$ .

# TYPICAL PERFORMANCE CURVES

## POSITIVE REGULATORS

DROPOUT VOLTAGE vs. OUTPUT CURRENT

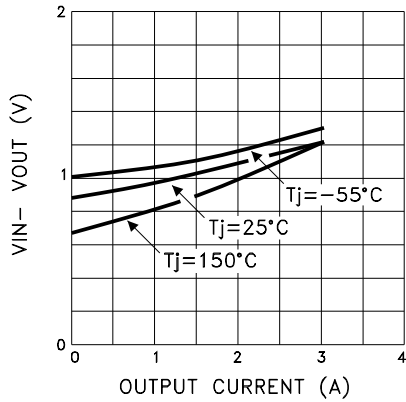

INTERNAL CURRENT LIMIT vs. VIN-VOUT

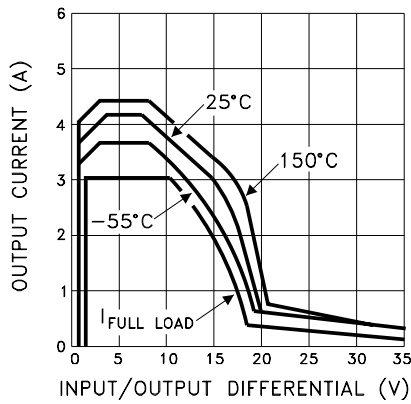

RIPPLE REJECTION vs. FREQUENCY

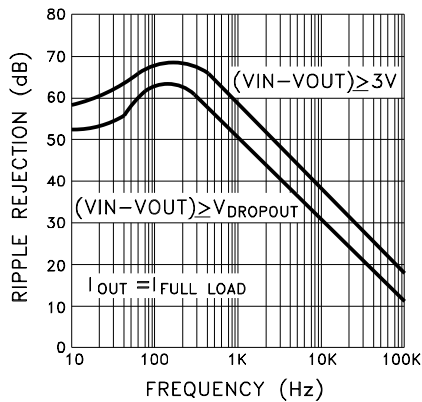

POWER DISSIPATION vs. TEMPERATURE

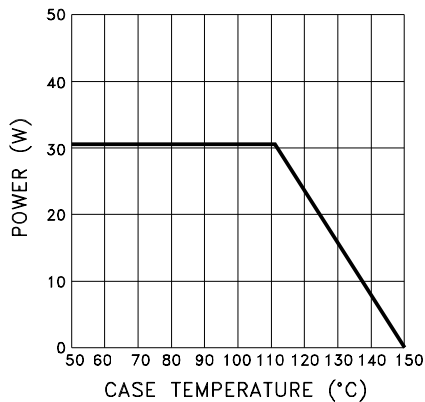

## NEGATIVE REGULATORS

DROPOUT VOLTAGE vs. OUTPUT CURRENT

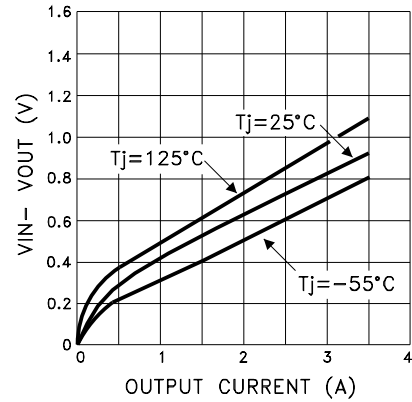

INTERNAL CURRENT LIMIT vs. VIN-VOUT

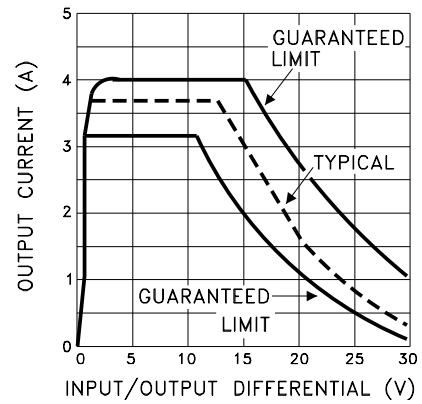

RIPPLE REJECTION vs. FREQUENCY

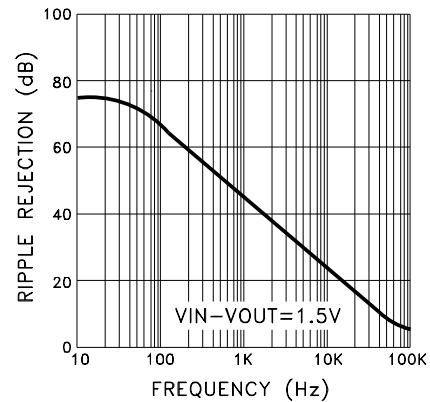

POWER DISSIPATION vs. TEMPERATURE

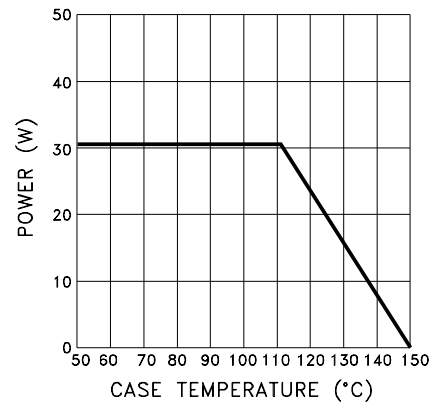

# MECHANICAL SPECIFICATIONS

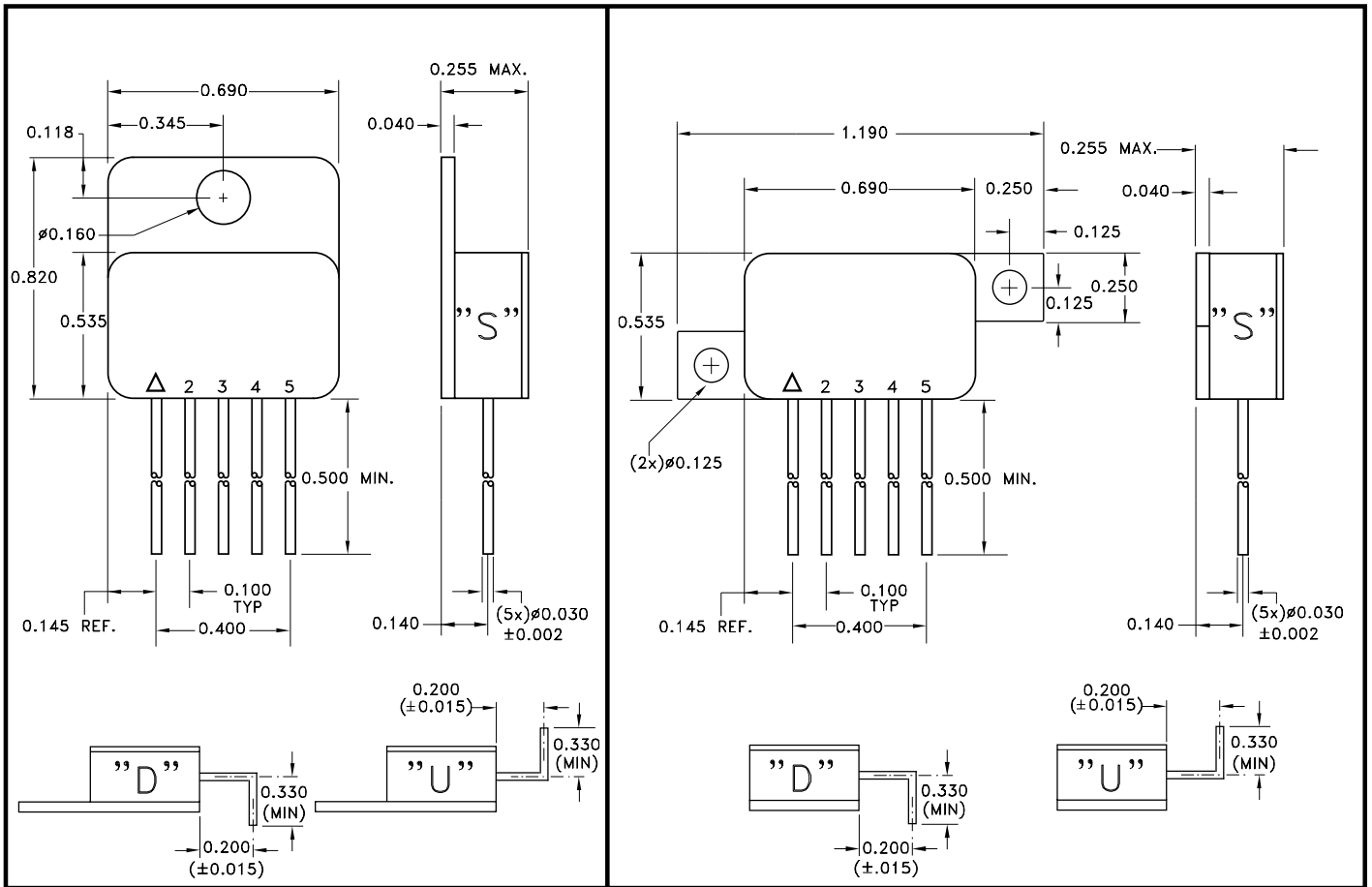

NOTE: ESD Triangle indicates Pin 1.

ALL DIMENSIONS ARE  $\pm 0.010$  INCHES UNLESS OTHERWISE LABELED

## ORDERING INFORMATION

MSK5000 B T U

### LEAD CONFIGURATIONS

S = STRAIGHT; U = BENT UP; D = BENT DOWN

### PACKAGE STYLE

T = TOP TAB; Z = Z PACK

### SCREENING

BLANK = INDUSTRIAL; B = MIL-PRF-38534

### GENERAL PART NUMBER

(VOLTAGE)

THE ABOVE EXAMPLE IS A: + 3.3V, -5.2V MILITARY REGULATOR USING THE TOP TAB PACKAGE WITH LEADS BENT UP.

M.S. Kennedy Corp.

4707 Dey Road, Liverpool, New York 13088

Phone (315) 701-6751

FAX (315) 701-6752

www.mskennedy.com

The information contained herein is believed to be accurate at the time of printing. MSK reserves the right to make changes to its products or specifications without notice, however, and assumes no liability for the use of its products.