



M.S.KENNEDY CORP.

HIGH EFFICIENCY, 4 AMP 1% ACCURATE SURFACE MOUNT SWITCHING REGULATORS

5040 SERIES

4707 Dey Road Liverpool, N.Y. 13088

(315) 701-6751

FEATURES:

- Up To 95% Efficiency For 5V Version
- 4 Amp Output Current
- 4.5V to 30V Input Range
- Preset 1.9V, 2.5V, 3.3V or 5.0V Output Versions
- 300KHz Switching Frequency @ 1 Amp
- User Programmable Soft-Start
- Quiescent Current < 2.5mA
- User Programmable Current Limit

MIL-PRF-38534 QUALIFIED

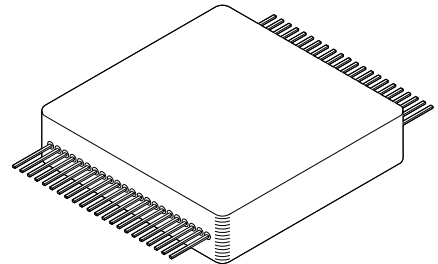

DESCRIPTION:

The MSK 5040 series are high efficiency, 4 amp, surface mount switching regulators. The output voltage is configured for 1.9V, 2.5V, 3.3V or 5.0V internally with a tolerance of 1% at 1.5 amps. The operating frequency of the MSK 5040 is 300KHz and is internally set. An external "soft start" capacitor allows the user to control how quickly the output comes up to regulation voltage after the application of an input. An extremely low quiescent current of typically less than 2.5mA and nearly 95% operating efficiency keep the total internal power dissipation of the MSK 5040 down to an absolute minimum.

EQUIVALENT SCHEMATIC

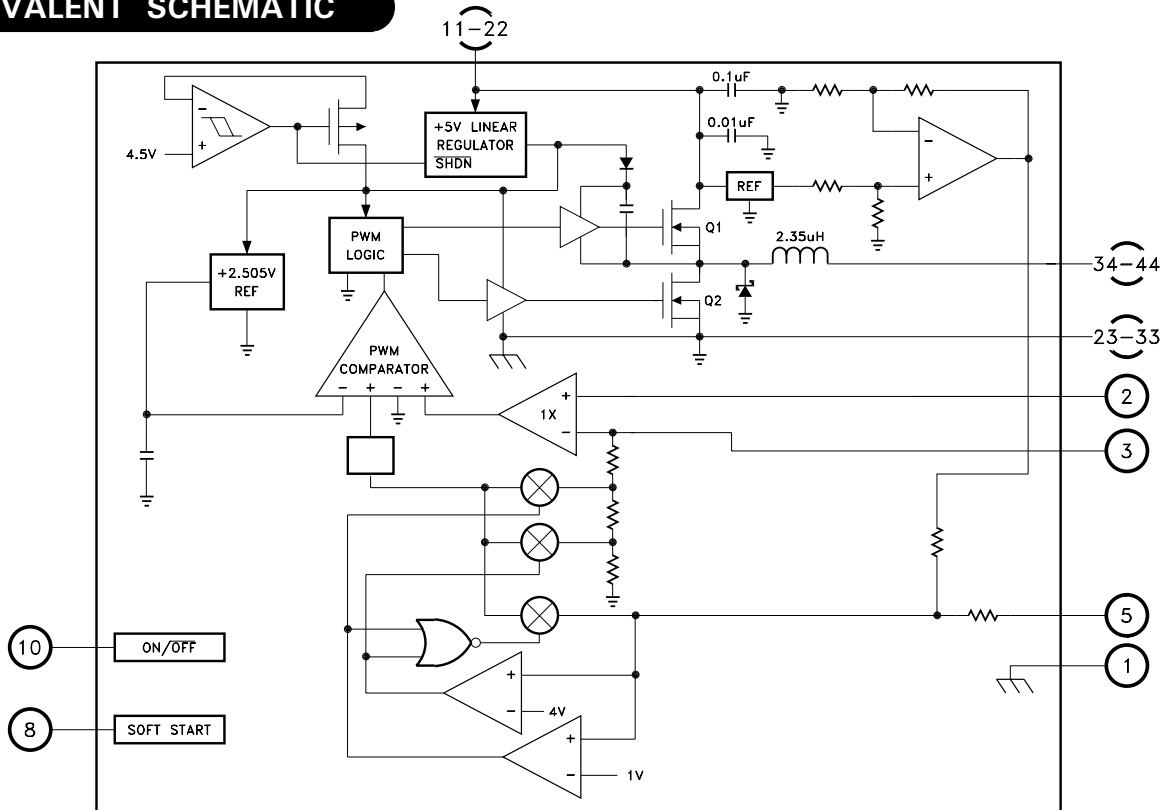

TYPICAL APPLICATIONS

- Step-down Switching Regulator
- Microprocessor Power Source
- High Efficiency Low Voltage Subsystem Power Supply

PIN-OUT INFORMATION

1	Case	34-44	Vout
2	Sense High	23-33	Ground
3	Sense Low	11-22	Vin
4	N/C	10	Enable
5	RF High	9	N/C
6	N/C	8	Cton
7	N/C		

ABSOLUTE MAXIMUM RATINGS

Input Voltage -0.3V, +36V
 Enable Voltage -0.3V, +36V
 Output Current 5.0 Amps
 Sense Pin Voltage -0.3V, +7V
 Thermal Resistance
 (Each MOSFET). 17°C/W

T_{ST} Storage Temperature Range . . . -65°C to +150°C
 T_{LD} Lead Temperature Range 300°C
 (10 Seconds)
 T_C Case Operating Temperature
 MSK5040 Series -40°C to +85°C
 MSK5040H/E Series -55°C to +125°C
 T_J Junction Temperature +150°C

ELECTRICAL SPECIFICATIONS

Parameter	Test Conditions ①	Group A Subgroup	MSK 5040 H/E SERIES			MSK 5040 SERIES			Units	
			Min.	Typ.	Max.	Min.	Typ.	Max.		
Input Supply Range ②		1,2,3	4.75	-	30	4.75	-	30	V	
Output Voltage 5040-1.9 ⑧	I _{OUT} = 1.5A V _{IN} = 5.0V	1	1.88	1.9	1.92	1.86	1.9	1.94	V	
		2,3	1.8	1.9	2.0	-	-	-	V	
Output Voltage 5040-2.5 ⑧	I _{OUT} = 1.5A V _{IN} = 5.0V	1	2.47	2.5	2.53	2.45	2.5	2.55	V	
		2,3	2.38	2.5	2.63	-	-	-	V	
Output Voltage 5040-3.3 ⑧	I _{OUT} = 1.5A V _{IN} = 5.0V	1	3.27	3.3	3.33	3.23	3.3	3.37	V	
		2,3	3.14	3.3	3.47	-	-	-	V	
Output Voltage 5040-5.0 ⑧	I _{OUT} = 1.5A V _{IN} = 6V	1	4.95	5.0	5.05	4.9	5.0	5.1	V	
		2,3	4.75	5.0	5.25	-	-	-	V	
Output Current ②	Within SOA	1	4.0	4.5	-	4.0	4.5	-	A	
Load Regulation	0.75A ≤ I _{OUT} ≤ 2.5A	-	-	1.5	-	-	1.5	-	%	
Line Regulation	I _{OUT} = 1A 6V ≤ V _{IN} ≤ 20V	1,2,3	-	0.06	0.10	-	0.06	0.15	%/V	
Oscillator Frequency ② ⑦	Internal I _{OUT} ≥ 1.5A	-	270	300	330	270	300	330	KHz	
Enable Input Voltage ②	High	1,2,3	2.0	-	-	2.0	-	-	V	
	Low	1,2,3	-	-	0.5	-	-	0.5	V	
Enable Input Current ②	V _{EN} = V _{IN}	1	-	0.5	2.0	-	0.5	2.0	μA	
	V _{EN} = 0V	1	-	0.2	2.0	-	0.2	2.0	μA	
Disabled Quiescent Current ②	V _{EN} = 0V V _{IN} = 30V	1	-	2.0	2.5	-	2.0	2.5	mA	
Current Limit Threshold ②	Positive	1	80	100	120	75	100	125	mV	
	Negative	1	-50	-100	-160	-45	-100	-165	mV	
C _{ton} Current ②	Source	1	2.5	4.0	6.5	2.5	4.0	6.5	μA	
	Fault Sink	1	2.0	-	-	2.0	-	-	mA	
Efficiency	5040-1.9	V _{IN} = 5.0V I _{OUT} = 1.5A	1	-	70	-	-	70	-	%
	5040-2.5	V _{IN} = 5.0V I _{OUT} = 1.5A	1	-	80	-	-	80	-	%
	5040-3.3	V _{IN} = 5.0V I _{OUT} = 1.5A	1	-	90	-	-	90	-	%
	5040-5.0	V _{IN} = 6V I _{OUT} = 1A	1	-	95	-	-	95	-	%

NOTES:

- ① V_{IN} = Enable, 5mV ≤ (sense high-sense low) ≤ 75mV, I_L = 0A, C_{OUT} = 6x330μF, C_{IN} = 6x220μF, C_{TON} = 0.01μF unless otherwise specified.
- ② This parameter is guaranteed by design but need not be tested. Typical parameters are representative of actual device performance but are for reference only.
- ③ All output parameters are tested using a low duty cycle pulse to maintain T_J = T_C.
- ④ Industrial grade and 'E' suffix devices shall be tested to subgroup 1 unless otherwise specified.
- ⑤ Military grade devices ('H' suffix) shall be 100% tested to subgroups 1,2 and 3.
- ⑥ Subgroup 1 T_A = T_C = +25°C
 Subgroup 2 T_A = T_C = +125°C
 Subgroup 3 T_A = T_C = -55°C
- ⑦ Actual switching frequency can be load dependent if output current is low. Refer to typical performance curves.
- ⑧ Alternate output voltages are available. Please contact the factory.

APPLICATION NOTES

CURRENT LIMITING:

The MSK 5040 is equipped with a pair of sense pins that are used to sense the load current using an external resistor (Rs). The current-limit circuit resets the main PWM latch and turns off the internal high-side MOSFET switch whenever the voltage difference between Sense High and Sense Low exceeds 100mV. This limiting occurs in both current flow directions, putting the threshold limit at $\pm 100\text{mV}$. The tolerance on the positive current limit is $\pm 20\%$. The external low-value sense resistor must be sized for $80\text{mV}/R_s$ to guarantee enough load capacity. Load components must be designed to withstand continuous current stresses of $120\text{mV}/R_s$.

For very high-current applications, it may be useful to wire the sense inputs with a twisted pair instead of PCB traces. This twisted pair needn't be anything unique, perhaps two pieces of wire-wrap wire twisted together. Low inductance current sense resistors, such as metal film surface mount styles are best.

SOFT START/Cton:

The internal soft-start circuitry allows a gradual increase of the internal current-limit level at start-up for the purpose of reducing input surge currents, and possibly for power-supply sequencing. In Disable mode, the soft-start circuit holds the Cton capacitor discharged to ground. When Enable goes high, a $4\mu\text{A}$ current source charges the Cton capacitor up to 3.2V. The resulting linear ramp causes the internal current-limit threshold to increase proportionally from 20mV to 100mV. The output capacitors charge up relatively slowly, depending on the Cton capacitor value. The exact time of the output rise depends on output capacitance and load current and is typically 1mS per nanofarad of soft-start capacitance. With no capacitor connected, maximum current limit is reached typically within $10\mu\text{S}$.

ENABLE FUNCTION:

The MSK 5040 is enabled by applying a logic level high to the Enable pin. A logic level low will disable the device and quiescent input current will reduce to approximately 2mA. The Enable threshold voltage is 1V. If automatic start up is required, simply connect the pin to VIN. Maximum Enable voltage is +36V.

POWER DISSIPATION:

In high current applications, it is very important to ensure that both MOSFETS are within their maximum junction temperature at high ambient temperatures. Temperature rise can be calculated based on package thermal resistance and worst case dissipation for each MOSFET. These worst case dissipations occur at minimum voltage for the high side MOSFET and at maximum voltage for the low side MOSFET.

Calculate power dissipation using the following formulas:

$$P_d (\text{upper FET}) = I_{\text{LOAD}}^2 \times 0.035\Omega \times \text{DUTY} + V_{\text{IN}} \times I_{\text{LOAD}} \times f \times \left[\frac{V_{\text{IN}} \times C_{\text{RSS}}}{I_{\text{GATE}}} + 20\text{ns} \right]$$

$$P_d (\text{lower FET}) = I_{\text{LOAD}}^2 \times 0.035\Omega \times (1 - \text{DUTY})$$

$$\text{DUTY} = \left[\frac{(V_{\text{OUT}} + V_{\text{Q2}})}{(V_{\text{IN}} - V_{\text{Q1}})} \right]$$

$$\text{Where: } V_{\text{Q1}} \text{ or } V_{\text{Q2}} (\text{on state voltage drop}) = I_{\text{LOAD}} \times 0.035\Omega$$

$$C_{\text{RSS}} = 94\text{pF}$$

$$I_{\text{GATE}} = 1\text{A}$$

During output short circuit, Q2, the synchronous-rectifier MOSFET, will have an increased duty factor and will see additional stress. This can be calculated by:

$$Q2 \text{ DUTY} = 1 - \left[\frac{V_{\text{Q2}}}{V_{\text{IN(MAX)}} - V_{\text{Q1}}} \right]$$

$$\text{Where: } V_{\text{Q1}} \text{ or } V_{\text{Q2}} = (120\text{mV}/R_{\text{SENSE}}) \times 0.035$$

INPUT CAPACITOR SELECTION:

The MSK 5040 has an internal high frequency ceramic capacitor (0.1uF) between VIN and GND. Connect a low-ESR bulk capacitor directly to the input pin of the MSK 5040. Select the bulk input filter capacitor according to input ripple-current requirements and voltage rating, rather than capacitor value. Electrolytic capacitors that have low enough ESR to meet the ripple-current requirement invariably have more than adequate capacitance values. Aluminum-electrolytic capacitors are preferred over tantalum types, which could cause power-up surge-current failure when connecting to robust AC adapters or low-impedance batteries. RMS input ripple current is determined by the input voltage and load current, with the worst possible case occurring at $V_{\text{IN}} = 2 \times V_{\text{OUT}}$:

$$I_{\text{RMS}} = I_{\text{LOAD}} \times \frac{\sqrt{V_{\text{OUT}}(V_{\text{IN}} - V_{\text{OUT}})}}{V_{\text{IN}}}$$

OUTPUT CAPACITOR SELECTION:

The output capacitor values are generally determined by the ESR and voltage rating requirements rather than capacitance requirements for stability. Low ESR capacitors that meet the ESR requirement usually have more output capacitance than required for stability. Only specialized low-ESR capacitors intended for switching-regulator applications, such as AVX TPS, Sprague 595D, Sanyo OS-CON, Nichicon PL series or Kemet T510 series should be used. The capacitor must meet minimum capacitance and maximum ESR values as given in the following equations:

$$C_f > \frac{2.5V(1 + V_{\text{OUT}}/V_{\text{IN(MIN)}})}{V_{\text{OUT}} \times R_{\text{SENSE}} \times f}$$

$$R_{\text{ESR}} < \frac{R_{\text{SENSE}} \times V_{\text{OUT}}}{2.5V}$$

These equations provide 45 degrees of phase margin to ensure jitter-free fixed-frequency operation and provide a damped output response for zero to full-load step changes. Lower quality capacitors can be used if the load lacks large step changes. Bench testing over temperature is recommended to verify acceptable noise and transient response. As phase margin is reduced, the first symptom is timing jitter, which shows up in the switching waveforms. Technically speaking, this typically harmless jitter is unstable operation, since the switching frequency is non-constant. As the capacitor ESR is increased, the jitter becomes worse. Eventually, the load-transient waveform has enough ringing on it that the peak noise levels exceed the output voltage tolerance. With zero phase margin and instability present, the output voltage noise never gets much worse than $I_{\text{PEAK}} \times R_{\text{ESR}}$ (under constant loads). Designers of industrial temperature range digital systems can usually multiply the calculated ESR value by a factor of 1.5 without hurting stability or transient response.

The output ripple is usually dominated by the ESR of the filter capacitors and can be approximated as $I_{\text{RIPPLE}} \times R_{\text{ESR}}$. Including the capacitive term, the full equation for ripple in the continuous mode is $V_{\text{NOISE(p-p)}} = I_{\text{RIPPLE}} \times (R_{\text{ESR}} + 1/(2\pi f C))$. In idle mode, the inductor current becomes discontinuous with high peaks and widely spaced pulses, so the noise can actually be higher at light load compared to full load. In idle mode, the output ripple can be calculated as follows:

$$V_{\text{NOISE(p-p)}} = \frac{0.02 \times R_{\text{ESR}}}{R_{\text{SENSE}}} + \frac{0.0003 \times 2.35\mu\text{H} \times [1/V_{\text{OUT}} + 1/(V_{\text{IN}} - V_{\text{OUT}})]}{(R_{\text{SENSE}})^2 \times C}$$

TYPICAL PERFORMANCE CURVES

EFFICIENCY vs LOAD CURRENT
MSK5040-2.5

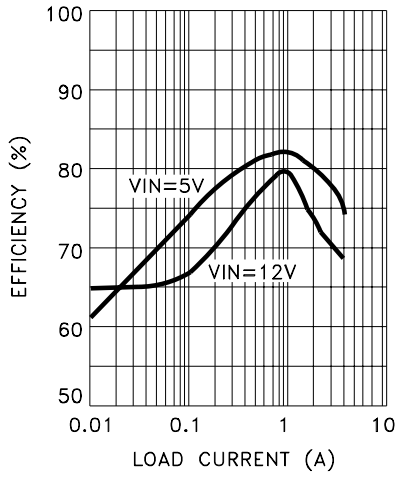

EFFICIENCY vs LOAD CURRENT
MSK5040-3.3

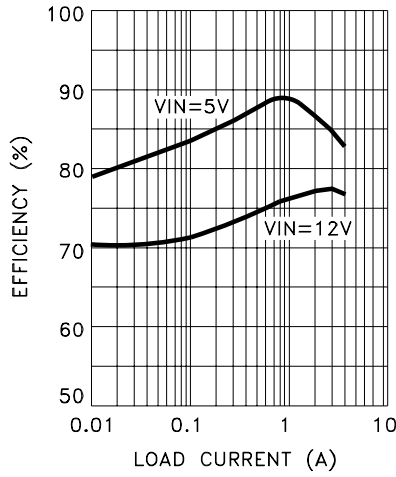

EFFICIENCY vs LOAD CURRENT
MSK5040-5.0

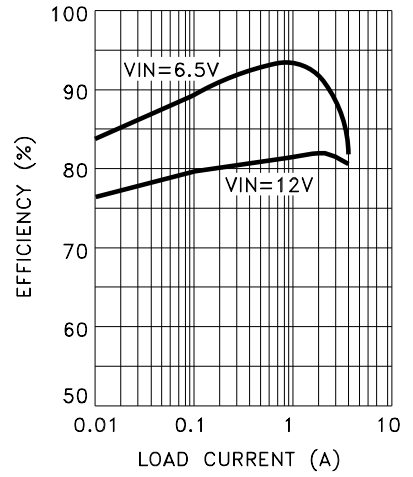

DROPOUT VOLTAGE vs LOAD CURRENT

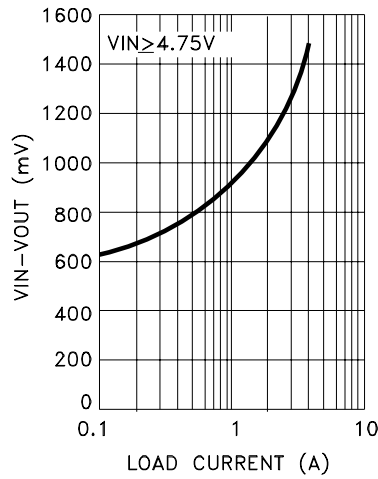

SWITCHING FREQUENCY vs LOAD CURRENT

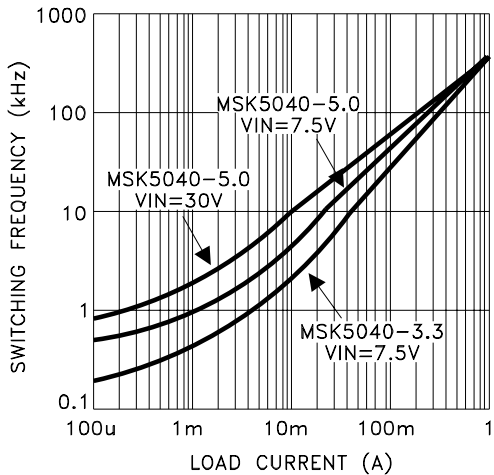

OUTPUT CURRENT vs TEMPERATURE

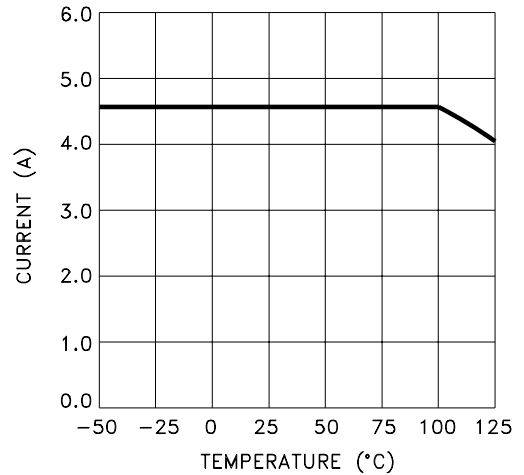

MECHANICAL SPECIFICATIONS

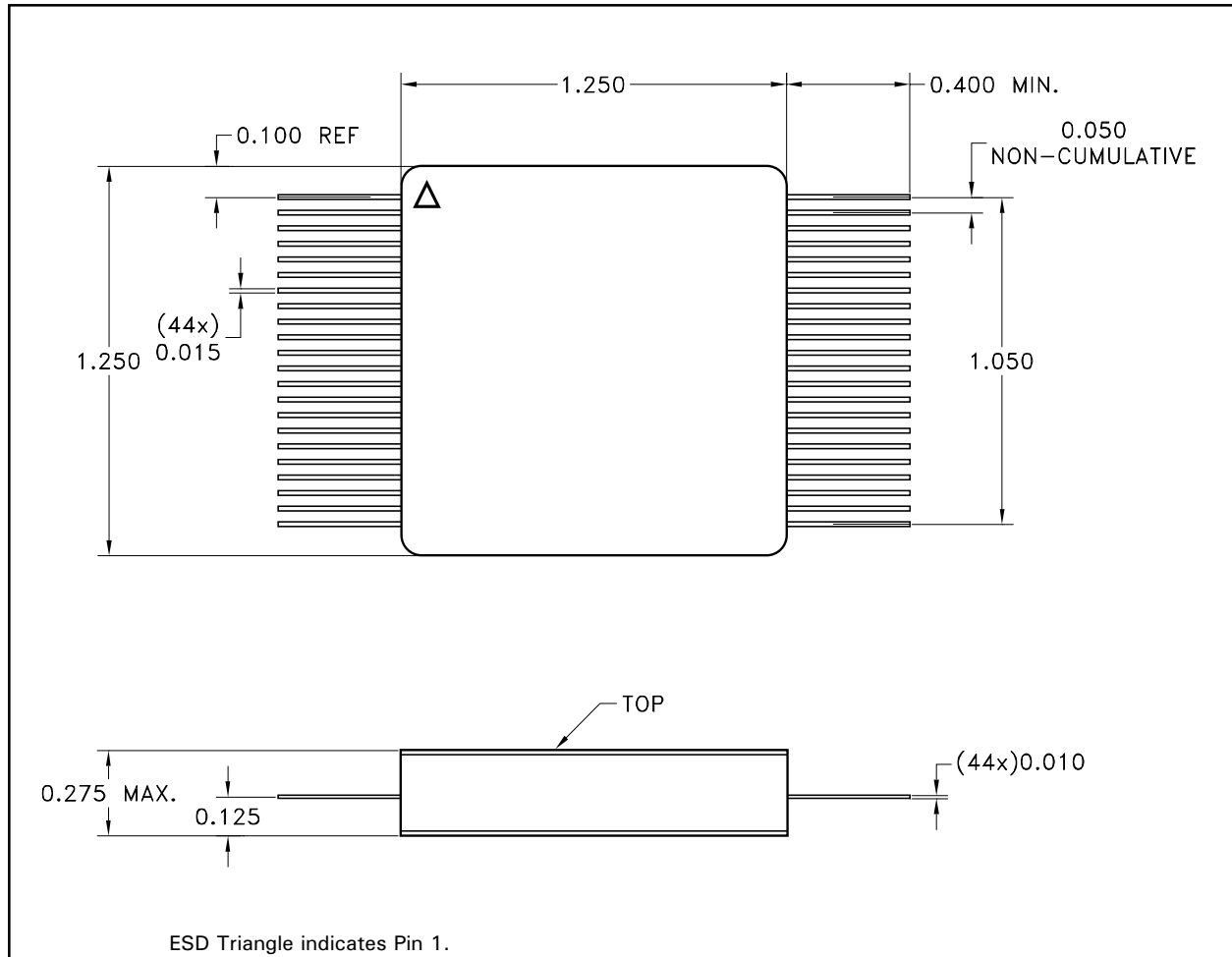

NOTE: ALL DIMENSIONS ARE ± 0.010 INCHES UNLESS OTHERWISE LABELED.
SPECIAL LEAD FORMING IS AVAILABLE. PLEASE CONTACT FACTORY IF REQUIRED.

ORDERING INFORMATION

MSK5040-3.3 H

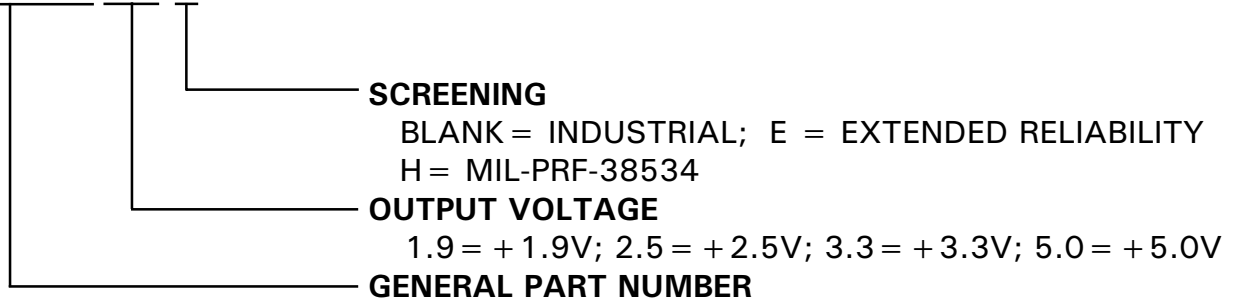

The above example is a + 3.3V, Military regulator.

M.S. Kennedy Corp.
4707 Dey Road, Liverpool, New York 13088
Phone (315) 701-6751
FAX (315) 701-6752
www.mskennedy.com

The information contained herein is believed to be accurate at the time of printing. MSK reserves the right to make changes to its products or specifications without notice, however, and assumes no liability for the use of its products. Please visit our website for the most recent revision of this datasheet.