

PHOTO IC COUPLER

MT6500, MT6510

T-41-83

APPLICATIONS

- DIGITAL LOGIC ISOLATION
- LINE RECEIVER FEEDBACK CONTROL
- POWER SUPPLY CONTROL
- SWITCHING POWER SUPPLY
- TRANSISTOR INVERTOR

Both the MT6500 and the MT6510 contain a high output emitting diode and a one chip photo diode transistor in an 8 lead dip package. The MT6500 has no internal base connection and is best suited for applications in noisy environmental conditions. The MT6510 contains an internal base connection and is used for analog applications or enable operation.

FEATURES

- Isolation Voltage : 5000V_{rms} Min.
- Switching Speed : t_{PHL}, t_{PLH}=0.5 μs (Typ.)
(R_L=1.9kΩ)
- TTL Compatible

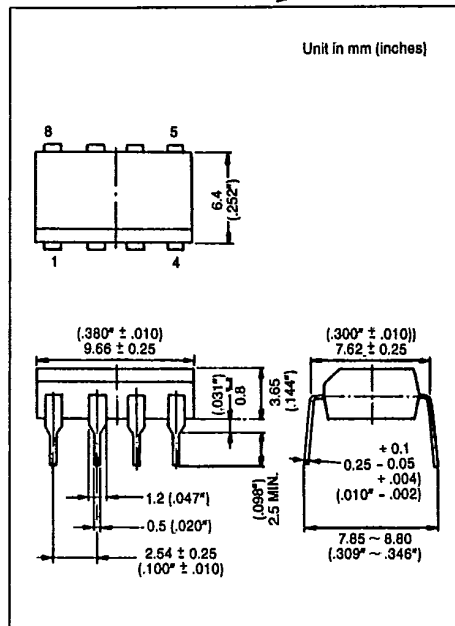

MT6500
PIN CONFIGURATIONS (TOP VIEW)

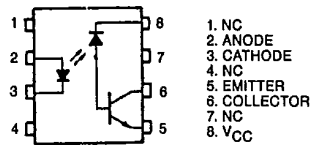

MT6510
PIN CONFIGURATIONS (TOP VIEW)

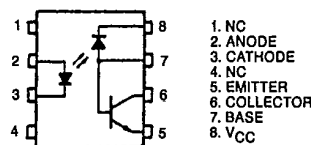

SCHEMATIC

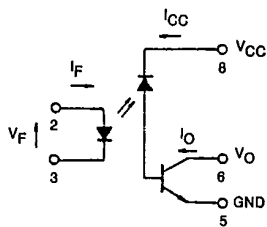

SCHEMATIC

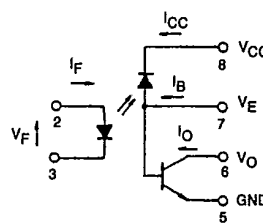

PHOTO IC COUPLER T-41-83

MAXIMUM RATINGS (Ta = 25°C)

CHARACTERISTIC		SYMBOL	RATING	UNIT
LED	Forward Current (Note 1)	I _F	25	mA
	Pulse Forward Current (Note 2)	I _{FP}	50	mA
	Total Pulse Forward Current (Note 3)	I _{FPT}	1	A
	Reverse Voltage	V _R	5	V
	Diode Power Dissipation (Note 4)	P _D	45	mW
DETECTOR	Output Current	I _O	8	mA
	Peak Output Current	I _{OP}	16	mA
	MT6500	—	—	—
	MT6510 Emitter-Base Reverse Voltage	V _{EB}	5	V
	Supply Voltage	V _{CC}	-0.5 ~ 15	V
	Output Voltage	V _O	-0.5 ~ 15	V
	MT6500	—	—	—
	MT6510 Base Current	I _B	5	mA
	Output Power Dissipation (Note 5)	P _O	100	mW
	Operating Temperature Range	T _{opr}	-55 ~ 100	°C
Storage Temperature Range	T _{stg}	-55 ~ 125	°C	
Isolation Voltage (Note 6)	BV _S	5000	V _{rms}	

Note 1: Derate 0.8mA above 70°C.

Note 2: 50% duty cycle, 1ms pulse width.
Derate 1.6mA/°C above 70°C.

Note 3: Pulse width 1µs, 300pps.

Note 4: Derate 0.9mW/°C above 70°C.

Note 5: Derate 2mW/°C above 70°C.

Note 6: R.H. = 40 ~ 60%, AC/1 min.

PHOTO IC COUPLER

T-41-83

ELECTRICAL CHARACTERISTICS (Ta=25°C)

CHARACTERISTIC		SYMBOL	TEST CONDITION	MIN.	TYP.	MAX.	UNIT
LED	Forward Voltage	V_F	$I_F=16mA$	1.45	1.65	1.85	V
	Forward Voltage Temperature Coefficient	$\Delta V_F/\Delta Ta$	$I_F=16mA$	—	-2	—	mV/°C
	Reverse Current	I_R	$V_R=5V$	—	—	10	μA
	Capacitance Between Terminal	C_T	$V_F=0, f=1MHz$	—	60	—	pF
DETECTOR	High Level Output Current	$I_{OH(1)}$	$I_F=0mA, V_{CC}=V_O=5.5V$	—	3	500	nA
		$I_{OH(2)}$	$I_F=0mA, V_{CC}=V_O=15V$	—	—	5	μA
		I_{OH}	$I_F=0mA, V_{CC}=V_O=15V, Ta=70^\circ C$	—	—	250	μA
	High Level Supply Voltage	I_{CCH}	$I_F=0mA, V_{CC}=15V$	—	0.01	1	μA
COUPLED	Current Transfer Ratio	I_O/I_F	$I_F=16mA$ $V_{CC}=4.5V$ $V_O=0.4V$ $Ta=25^\circ C$	10	30	—	%
			rank: 0	19	30	—	
			$Ta=0 \sim 70^\circ C$	5	—	—	
			rank: 0	15	—	—	
	Low Level Output Voltage	V_{OL}	$I_F=16mA, V_{CC}=4.5V$ $I_O=1.1mA$ (rank 0: $I_O=2.4mA$)	—	—	0.4	V
Isolation Resistance	R_S	R.H. = 40~60%, V=1kV DC (Note 9)	—	10^{12}	—	Ω	
Capacitance Between Input to Output	C_S	$V=0, f=1MHz$	—	0.8	—	pF	

SWITCHING CHARACTERISTICS (Ta=25°C, VCC=5V)

CHARACTERISTIC		SYMBOL	TEST CONDITION	MIN.	TYP.	MAX.	UNIT
Propagation Delay Time (H→L)		t_{pHL}	$I_F=0 \rightarrow 16mA, V_{CC}=5V, R_L=4.1k\Omega$ (Note 7)	—	0.3	0.8	μs
			rank 0: $R_L=1.9k\Omega$	—	0.5	0.8	
Propagation Delay Time (L→H)		t_{pLH}	$I_F=16 \rightarrow 0mA, V_{CC}=5V, R_L=4.1k\Omega$ (Note 7)	—	1.0	2.0	μs
			rank 0: $R_L=1.9k\Omega$	—	0.6	1.2	
Common Mode Transient Immunity at Logic High Output	MT6500	CM_H	$I_F=0mA, V_{CM}=200V_{p-p}$ $R_L=4.1k\Omega$, (Rank 0: $R_L=1.9k\Omega$) (Note 8)	—	1500	—	V/ μs
	MT6510			—	400	—	
Common Mode Transient Immunity at Logic Low Output	MT6500	CM_L	$I_F=16mA, V_{CM}=200V_{p-p}$ $R_L=4.1k\Omega$, (Rank 0: $R_L=1.9k\Omega$) (Note 8)	—	-1500	—	V/ μs
	MT6510			—	-1000	—	

PHOTO IC COUPLER *T-41-83*

MT6500

Note 7. Switching Time Test Circuit

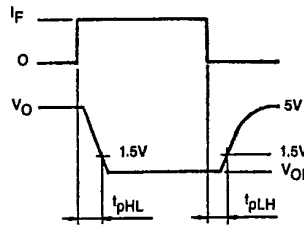
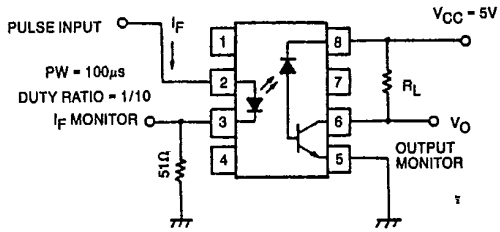

MT6510

Note 7. Switching Time Test Circuit

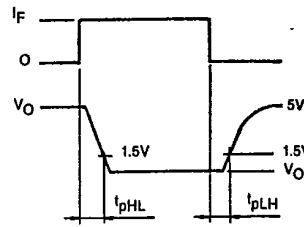
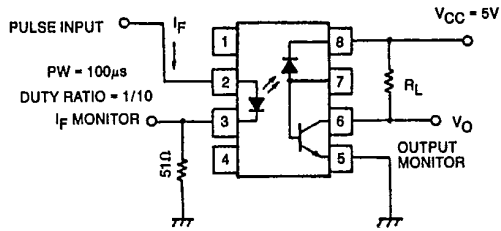
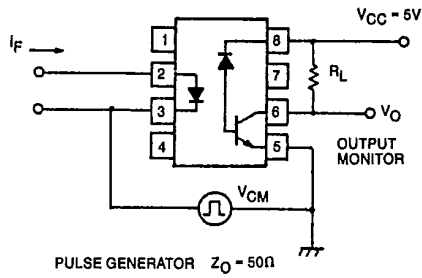

PHOTO IC COUPLER

T-41-83

MT6500

Note 8. Common Mode Noise Immunity Test Circuit



$$C_{MH} = \frac{160[V]}{t_r [\mu s]} \rightarrow C_{ML} = \frac{160[V]}{t_f [\mu s]}$$

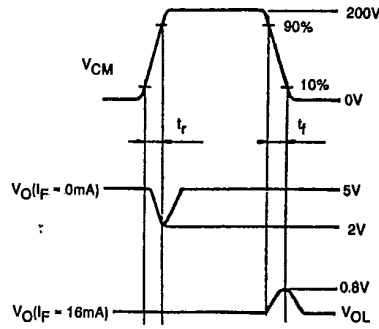

Note 9. Device considered a two-terminal device: Pins 1,2,3 and 4 shorted together and Pin 5,6,7 and 8 shorted together.

MT6510

Note 8. Common Mode Noise Immunity Test Circuit

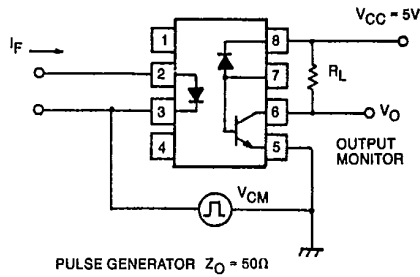

$$C_{MH} = \frac{160[V]}{t_r [\mu s]} \rightarrow C_{ML} = \frac{160[V]}{t_f [\mu s]}$$

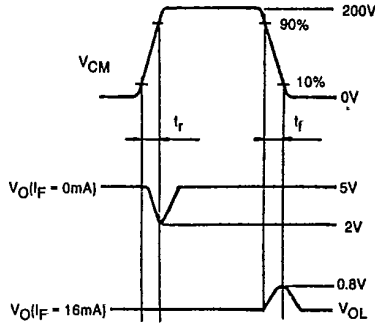

Note 9. Device considered a two-terminal device: Pins 1,2,3 and 4 shorted together and Pin 5,6,7 and 8 shorted together.

PHOTO IC COUPLER

T-41-83

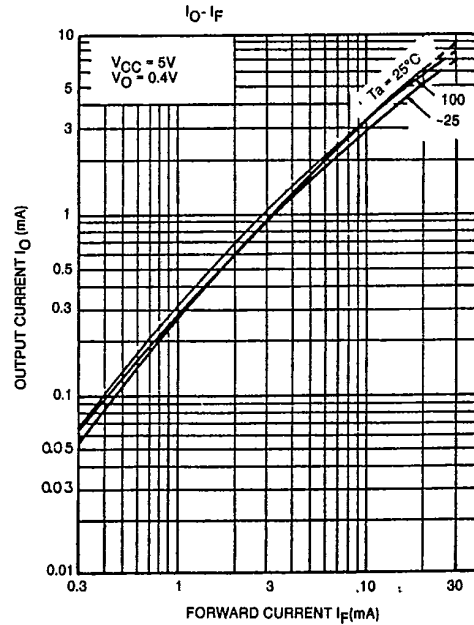
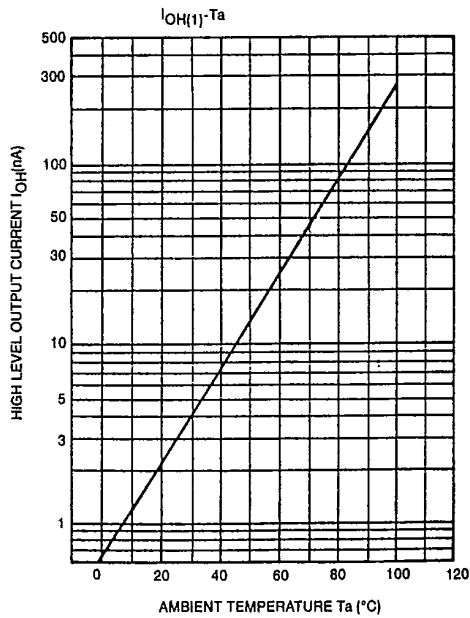
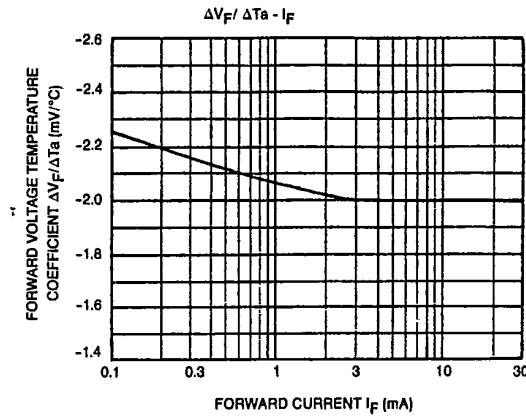
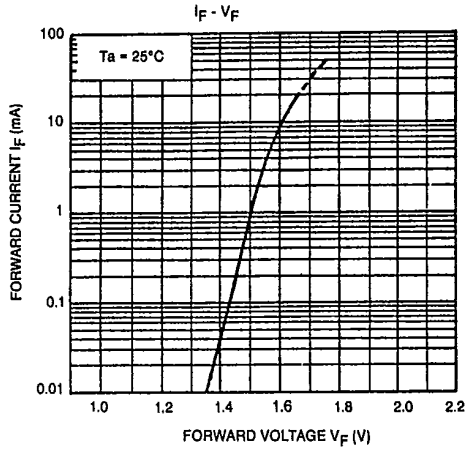

PHOTO IC COUPLER

T-41-83

