

# XGA Flat Panel Controller

## FEATURES

### General

- Auto configuration of sampling clock frequency, phase, H/V center, as well as white balance.
- Auto detection of present or non-present or over range sync signals and their polarities.
- Composite sync separation and odd/even field detection of interlaced video.
- On-chip output PLL provide clock frequency fine-tune (inverse, duty cycle and delay).
- Selection of serial 2-wire I<sup>2</sup>C or 8-bit direct host interface to 8-bit MCU.
- 3.3V supplier, 5V I/O tolerance in 256-pin PQFP or 272-pin BGA package.

### Input Processor

- Single RGB (24-bit) or Dual RGB (48-bit) input rates up to 100MHz.
- Support both non-interlaced and interlaced RGB graphic input signals.
- YUV 4:2:2 or YUV 4:1:1 (CCIR601) interlaced video input.
- Glue-less connection to Philips SAA711x digital video decoder.
- Built-in YUV to RGB color space converter.
- Compliant with digital LVDS/PanelLink TMDS input interface.
- PC input resolution up to XGA 1024x768 @85Hz.

### Video Processor

- Independent programmable Horizontal and Vertical scaling ratios from 1/32 to 32
- Flexible de-interlacing unit for digital YUV video input data.
- Zoom to full screen resolution of de-interlaced YUV video data stream.
- Built-in programmable gain control for white balance alignments.
- Built-in programmable 8-bit or 10-bit gamma correction table.
- Built-in programmable temporal color dithering.
- Built-in programmable interpolation look-up table.
- Support smooth panning under viewing window change.

### Output Processor

- Single pixel (18/24-bit) or Dual pixel (36/48-bit) per clock digital RGB output.
- Built-in output timing generator with programmable clock and H/V sync.
- Support VGA/SVGA/XGA display resolution.
- Overlay input interface with external OSD controller.
- Double scan capability for interlaced input.

### Memory Interface

- Support 48/32/24 bit bus width, SDRAM/SGRAM x2 or x3 configuration.
- Optional display through internal line buffer without external frame-buffer memory.
- Support power down mode.

## GENERAL DESCRIPTION

The MTL001 Flat Panel Display (FPD) Controller is an input format converter for TFT-LCD Monitor or LCD TV application which accepts 15-pin D-sub RGB graphic signals (through ADC), YUV signals from digital video decoder or digital RGB graphic signals from PanelLink TMDS receiver. It includes a RGB/YUV input processor, configurable frame-buffer memory interface, video scaling up/down processor, OSD input interface and output display processor in 256-pin PQFP or 272-pin BGA package.

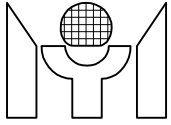

**BLOCK DIAGRAM**

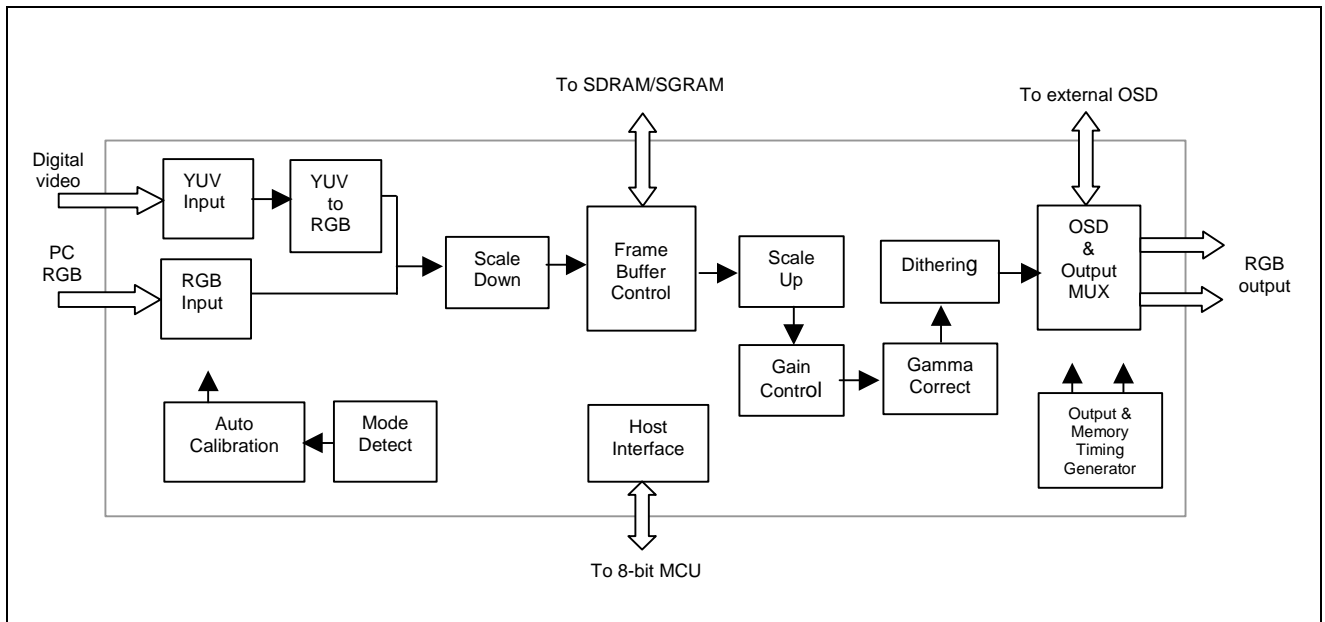

**APPLICATIONS**

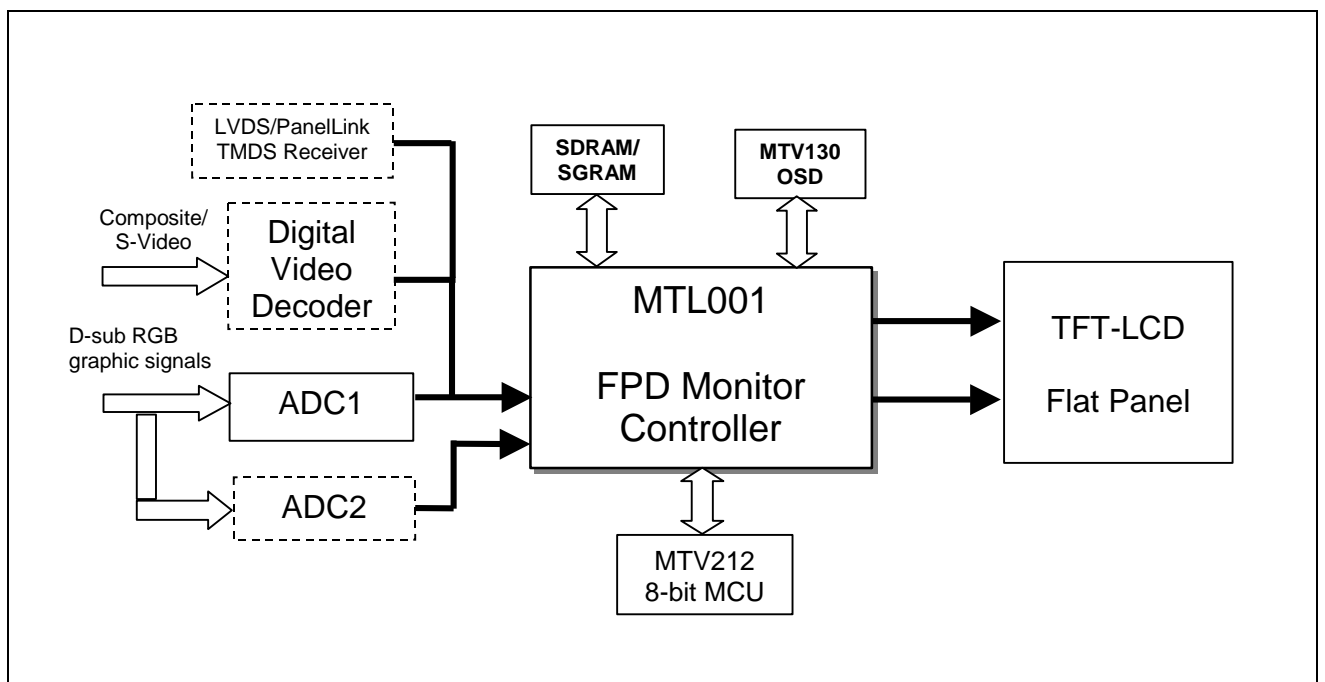

This datasheet contains new product information. Myson Technology reserves the rights to modify the product specification without notice. No liability is assumed as a result of the use of this product. No rights under any patent accompany the sale of the product.

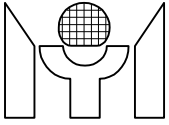

1. PIN CONNECTION

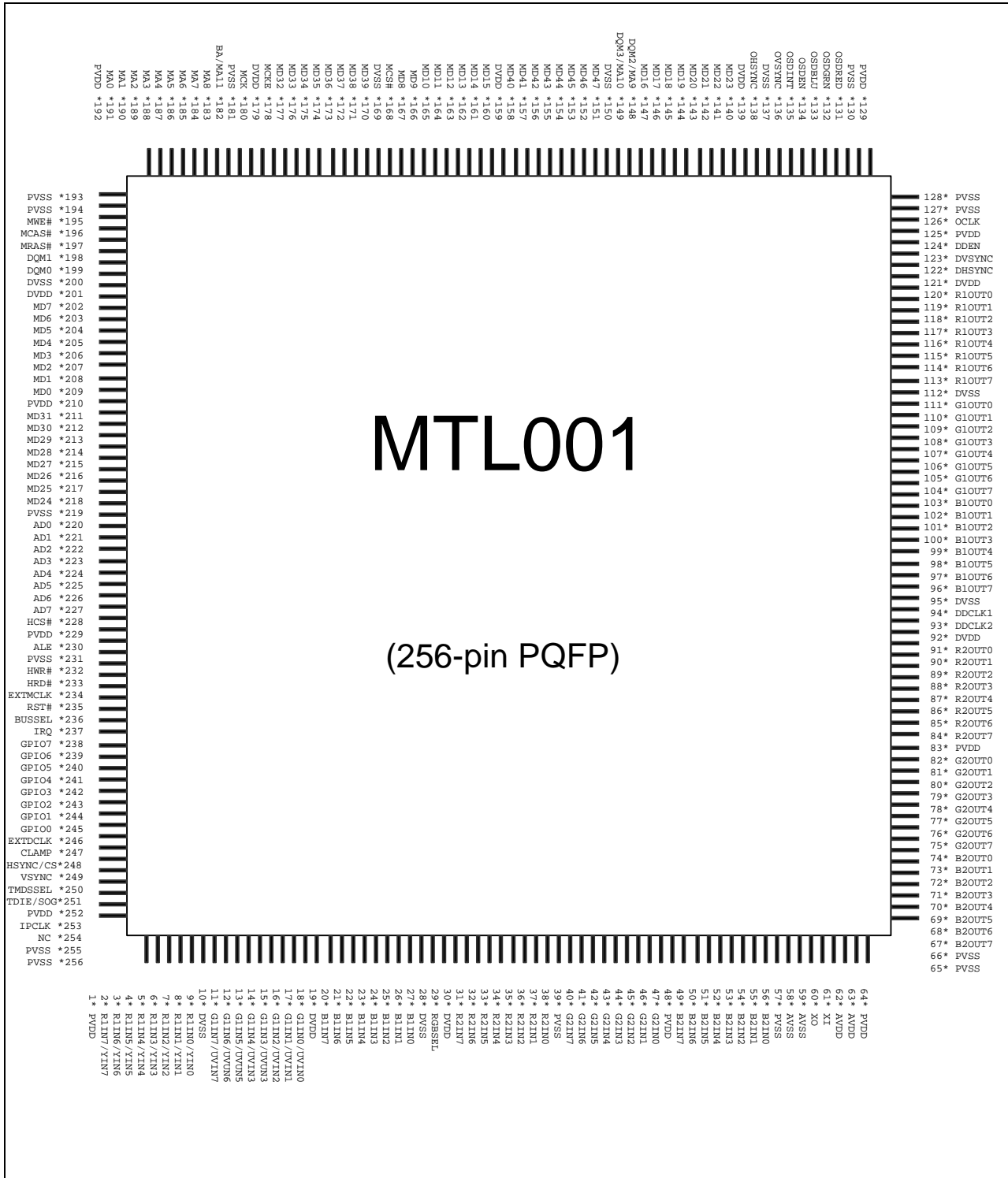

Note: Pin connection of 272-pin BGA to be defined later

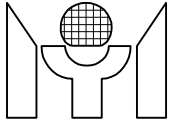

## 2. PIN DESCRIPTION

### ADC1 Input Interface (YUV or RGB or TMDS Input Data)

Name	Type	Pin#	Description
VSYNC	I	249	Vertical sync input
HSYNC/CS	I	248	Horizontal or Composite sync input
RGBSEL	O	29	Input select. 1:RGB input, 0:YUV input
TMDSSEL	O	250	TMDS input select, active high
CLAMP	O	247	Clamp pulse output for ADC
IPCLK	I	253	Input pixel clock
R1IN[7:0]/YIN[7:0]	I	2-9	Red or Y channel or TMDS input data (Single/Dual ADC)
G1IN[7:0]/UVIN[7:0]	I	11-18	Green or UV channel or TMDS input data (Single/Dual ADC)
B1IN[7:0]	I	20-27	Blue channel or TMDS input data (Single/Dual ADC)
TDIE	I	251	TMDS digital input enable

### ADC2 Input Interface (RGB Data)

Name	Type	Pin#	Description
R2IN[7:0]	I	31-38	Red channel input data (Dual ADC) or Control bit for YUV video input Bit 4: VPHREF, Video input Horizontal reference signal Bit 3: VPVS, Video input VSYNC signal Bit 2: VPODD, Video input ODD/EVEN field signal Bit 1: VPHS, Video input HSYNC signal Bit 0: VPCLK, Video input clock signal
G2IN[7:0]	I	40-47	Green channel input data (Dual ADC)
B2IN[7:0]	I	49-56	Blue channel input data (Dual ADC)

### Display Output Interface

Name	Type	Pin#	Description
DDEN	O	124	Display data output enable for LCD panel
DVSYNC	O	123	Display Vertical sync output
DHSYNC	O	122	Display Horizontal sync output
DDCLK1	O	94	Display output clock for odd data
DDCLK2	O	93	Display output clock for even data
R1OUT[7:0]	O	113-120	Red output even data , bit[7:2] for 6-bit panel
G1OUT[7:0]	O	104-111	Green output even data , bit[7:2] for 6-bit panel
B1OUT[7:0]	O	96-103	Blue output even data , bit[7:2] for 6-bit panel
R2OUT[7:0]	O	84-91	Red output odd data , bit[7:2] for 6-bit panel
G2OUT[7:0]	O	75-82	Green output odd data , bit[7:2] for 6-bit panel
B2OUT[7:0]	O	67-74	Blue output odd data , bit[7:2] for 6-bit panel

### Memory Interface

Name	Type	Pin#	Description
MCK	O	180	Memory output clock
MCKE	O	178	Memory clock enable
MCS#	O	168	Memory chip select, active low.
MRAS#	O	197	Memory row address strobe, active low
MCAS#	O	196	Memory column address strobe, active low
MWE#	O	195	Memory write enable, active low
DQM[1:0]	O	198-199	Memory data mask byte enable
BA/MA11	O	182	Memory bank address or Memory address line
DQM3/MA10	O	149	SGRAM data mask byte enable or SDRAM address line
DQM2/MA9	O	148	SGRAM data mask byte enable or SDRAM address line
MA[8:0]	O	183-191	Memory address line

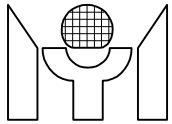

MD[47:40]	I/O	151-158	Memory Blue (B1) data
MD[39:32]	I/O	170-177	Memory Green (G1) data
MD[31:24]	I/O	211-218	Memory Red (R1) data
MD[23:16]	I/O	140-147	Memory Blue (B0) data
MD[15:8]	I/O	160-167	Memory Green (G0) data
MD[7:0]	I/O	202-209	Memory Red (R0) data

### Host Interface

Name	Type	Pin#	Description
RST#	I	235	System reset input, active low.
AD[7:0]	I/O	227-220	The address and data bus of 8-bit direct interface or 2-wire I <sup>2</sup> C series bus Bit 1: SDA, serial bus data Bit 0: SCK, serial bus clock
HWR#	I	232	Host write strobe, active low
HRD#	I	233	Host read strobe, active low
ALE	I	230	Host address latch enable for 8-bit direct bus
HCS#	I	228	Host chip select
BUSSEL	I	236	Bus mode selection. 0: I <sup>2</sup> C bus, 1: 8-bit direct bus
IRQ	O	237	Interrupt request output

### OSD Interface

Name	Type	Pin#	Description
OCLK	O	126	Clock for external OSD
OVSYNC	O	136	Vertical sync for external OSD
OHSYNC	O	138	Horizontal sync for external OSD
OSDRED	I	131	OSD red input
OSDGRN	I	132	OSD green input
OSDBLU	I	133	OSD blue input
OSDINT	I	135	OSD intensity input
OSDEN	I	134	OSD overlay enable

### Other Interface

Name	Type	Pin#	Description
XI	I	61	Oscillator frequency input
XO	O	60	Oscillator frequency output
EXTDCLK	I	246	External display clock input
EXTMCLK	I	234	External memory clock input
GPIO[7:0]	I/O	238-245	General purpose I/O or Bit 7: ADVS, Vertical sync for A/D converter Bit 6: ADHS, Horizontal sync for A/D converter Bit 2: MA9_SGRAM, Memory address 9 for SGRAM Bit 0: RAWHS/SOG, Input source HSYNC or Input Sync On Green Default: Bit[7:2]: Output direction Bit[1:0]: Input direction
NC	-	254	No connection

### 3.3V Power and Ground

Name	Pin#	Description
DVDD	19, 30, 92, 121, 139, 159, 179, 201	Digital power 3.3V
DVSS	10, 28, 95, 112, 137, 150, 169, 200	Digital ground
PVDD	1, 48, 64, 83, 125, 129, 192, 210, 229, 252	Pad power 3.3V
PVSS	39, 57, 65, 66, 127, 128, 130, 181, 193, 194,	Pad ground

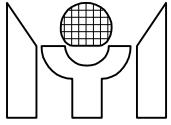

---

---

	219, 231, 255, 256	
AVDD	62, 63	Analog power 3.3V
AVSS	58, 59	Analog ground

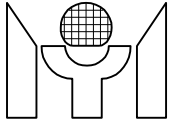

## 3. FUNCTIONAL DESCRIPTION

### 3.1 Input Processor

#### General Description

The function of Input Interface is to provide the interface between MTL001 and external input devices. It can process both non-interlaced and interlaced RGB graphic input, YUV video input, and digital RGB input compliant with digital LVDS/PanelLink TMDS interface. It also contains the Decimation circuit to scale down the input image with arbitrary ratios down to 1/32 and the built-in YUV to RGB color space converter.

#### 3.1.1 RGB Input Format

The RGB input port can work in two modes: Single Pixel mode (24 bits) and Double Pixel mode (48 bits). For Single Pixel mode, only the ports R1IN[7:0], G1IN[7:0], and B1IN[7:0] are internally sampled. For Double Pixel mode, besides the ports R1IN[7:0], G1IN[7:0], and B1IN[7:0], the ports R2IN[7:0], G2IN[7:0], and B2IN[7:0] are needed additionally. The R/G/B1IN ports are sampled at the rising edge of the RGB input clock, and the R/G/B2IN ports are sampled at the falling edge.

#### 3.1.2 TMDS Input Format

The Digital RGB input port works just in the same way as Sec 3.1.1 except that pin "Digital Input Enable DIEN" is needed.

With a flexible single or double pixel input interface, the supported format is up to true color, including the 18 bit/pixel or 24 bit/pixel in 1 or 2 pixels/clock mode.

#### 3.1.3 YUV Input Format

The YUV input port supports interlaced video data from the most common video decoder ICs like SAA711x. The 16 bit data bus is shared by ports R1IN[7:0] and G1IN[7:0]. The 5 bit control signals are shared with the port R2IN[4:0]. The 16 bit data is sampled at the rising edge of the shared video clock VPCLK when the shared data enable HREF is active. The supported formats are YUV4:1:1 and YUV4:2:2 with CCIR601 standard.

#### 3.1.4 YUV to RGB Converter

It is used to convert YCbCr format into RGB format. The basic equations are as follows:

$$\begin{aligned}R &= Y + 1.371(Cr - 128) \\G &= Y - 0.698(Cr - 128) - 0.336(Cb - 128) \\B &= Y + 1.732(Cb - 128)\end{aligned}$$

#### 3.1.5 De-interlace mode

For interlace input, MTL001 features several de-interlacing algorithms for processing interlaced video data depending on the type of input images.

##### Ā Static Mode

In this mode, the first and second fields are simply put together without any filtering. Memory for two fields is needed. It is commonly used in still image input.

##### Ā Toggle Mode

In this mode, only one field is displayed at a time. First field and second field is toggling displayed. The missing lines are calculated from duplicating the neighboring lines. For moving picture, it has a good quality.

##### Ā Spatial Mode

In this mode, two fields are toggled displayed, just like Toggle mode. The missing lines are calculated from interpolating the neighboring lines. This mode has a generally good quality for still and moving picture.

#### 3.1.6 Sync Processor

The V/H SYNC processing block performs the functions of Composite signal separation/insertion, SYNC inputs the presence check, frequency counting, polarity detection and control. It contains a de-glitch circuit to filter out any pulse shorter than one OSC period which is treated as noise among V/H SYNC pulses.



## Ā **V/H SYNC Frequency Counter**

MTL001 measures VSYNC/HSYNC frequency counted in the proper clock and save the information in register. Users can read the figure and calculate VSYNC/HSYNC frequency using the following formulae:

$$f_{\text{vsync}} = f_{\text{osc}} / N_{\text{vsync}} \quad F \ 1/256$$

$$f_{\text{hsync}} = f_{\text{osc}} / N_{\text{hsync}} \quad F \ 8$$

Where

- $f_{\text{vsync}}$  : VSYNC frequency
- $f_{\text{hsync}}$  : HSYNC frequency
- $f_{\text{osc}}$  : oscillator clock with 14.31818 MHz
- $N_{\text{vsync}}$  : counted number of VSYNC
- $N_{\text{hsync}}$  : counted number of HSYNC

## Ā **V/H SYNC Presence Check**

This function checks the input VSYNC, where Vpre flag is set when VSYNC is over 40Hz or cleared when VSYNC is under 10Hz and the input is HSYNC, where Hpre flag is set when HSYNC is over 10KHz or cleared when HSYNC is under 10Hz.

## Ā **V/H Polarity Detect**

This function detects the input VSYNC/HSYNC high and low pulse duty cycle. If the high pulse duration is longer than that of low pulse, the negative polarity is asserted; otherwise, positive polarity is asserted.

## Ā **Composite SYNC separation/insertion**

MTL001 continuously monitors the input HSYNC. If the input VSYNC can be extracted from it, a CVpre flag is set. MTL001 can insert HSYNC pulse during Composite VSYNC's active time and the insertion frequency can adapt to original HSYNC's.

## **3.1.7 Auto Tune**

Auto Tune function consists of Auto Position that automatically centering the screen and Auto Calibration which contains Phase Calibration, Histogram, Min/Max Value, and Pixel Grab described as below. With this auto adjustment support it is possible to measure the correct phase, frequency, gain, and offset of ADC. The horizontal and vertical back porches of input image and the horizontal and vertical active regions can also be measured. Firmware can adjust input image registers automatically by reading Auto Tune's registers in single or burst mode.

### Ā **Auto Position**

MTL001 provides Horizontal/Vertical back porch and active region values. Users can use these values to set input sample registers to aid in centering the screen automatically.

### Ā **Phase Calibration**

MTL001 provides Auto Calibration registers to measure the quality of current ADC's phase and frequency. The biggest Auto Calibration registers value means the right value of ADC's phase and frequency. MTL001 has two kinds of algorithms to calculate Auto Calibration's value. One is the traditional Difference method, the other is MYSON's proprietary method; the latter one is recommended for a better performance.

### Ā **Histogram**

Histogram means the total number of input pixels below/above one threshold value, for individual R/G/B colors. This advanced function helps the firmware to analyze ADC performance. Usually the firmware can use this information to measure ADC's noise margin, and adjust its offset and gain, or even aid in the mode detection.

### Ā **Min/Max Value**

Min/Max value means minimum or maximum pixel value within the specified input active image region for each RGB channel. This information is usually used to adjust ADC's offset and gain.

### Ā **Pixel Grab**

Pixel Grab means users can grab a single input pixel at any one point. The position of the point can be programmed by users. This is another traditional method to measure ADC's phase and frequency.



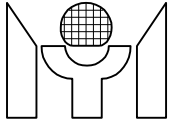

### 3.2 Video Processor

#### General Description

MTL001 possesses a powerful and programmable video processor by providing the following functions: Scaling Up/Down, Gain Control, Brightness Control, Gamma Correction, and Dithering Control.

The block diagram of Video Processor is as follows:

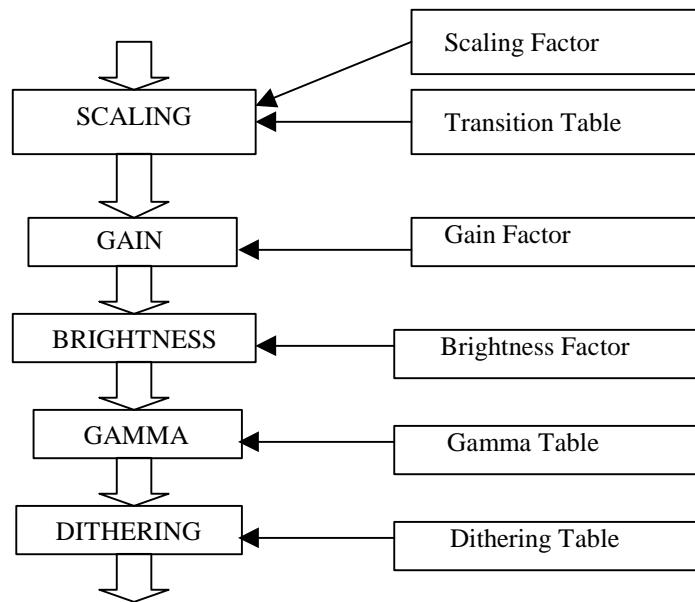

Fig. 3.2.1 Video Processor Block Diagram

#### 3.2.1 Scaling

MTL001 provides scaling function ranging from 1/32 to 32 for both up and down scaling, and for both horizontal and vertical processing. Note that the up and down scaling cannot operate in the same time, because they share the same line buffers.

For scaling up, both horizontal and vertical processing, MTL001 provides four methods:

- ⌘ **Pass Mode:** Image will be passed through without considering any scaling factor.
- ⌘ **Duplicate Mode:** Image will be scaled up/down based on scaling factor. Every point of output image comes from the input. In this method, Output image will have the good contrast but may be non-uniformed.
- ⌘ **Bilinear Mode:** Image will be scaled up/down based on scaling factor. Every point of output image data will be filtered by bilinear filter. In this method, output image will have the good scaling quality but may be blurred.
- ⌘ **Interpolation Table Mode:** Image will be scaled up/down based on scaling factor. Every point of output image data will be filtered by the user defined filter.

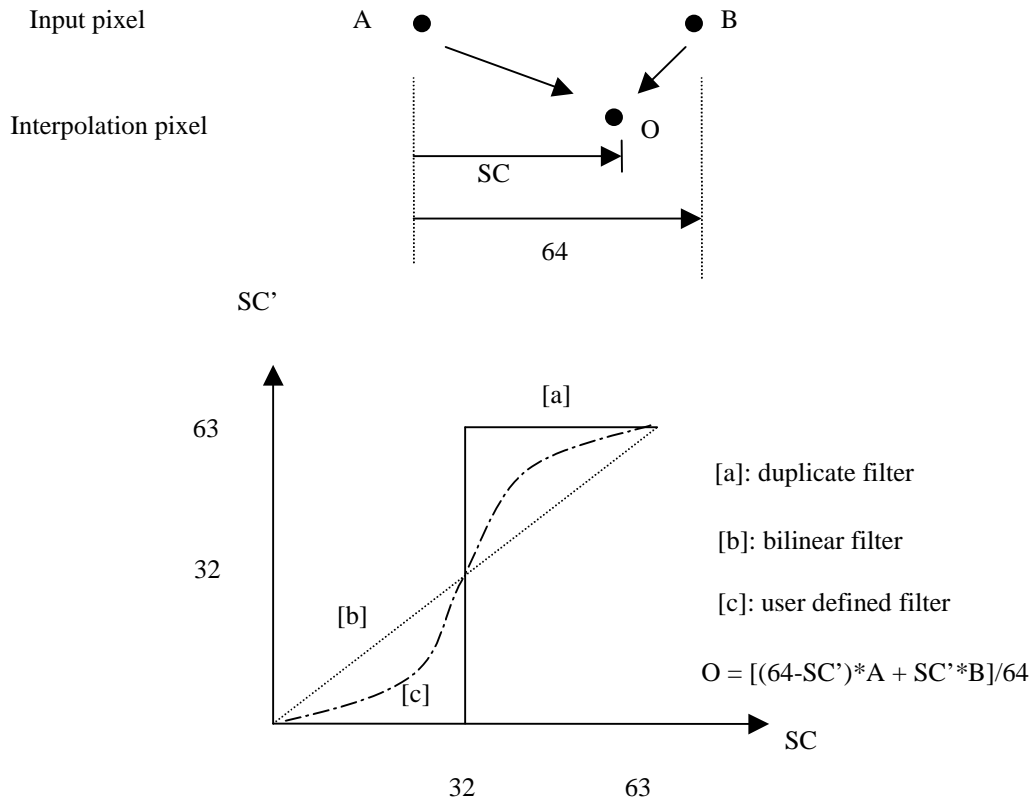
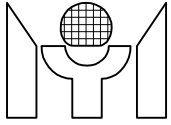

Fig. 3.2.2 Scaling filter

Note: For scaling down, for both horizontal and vertical processing, MTL001 provides three methods: Pass mode, Duplicate mode, and Bilinear mode.

### 3.2.2 Gain/Brightness Control

MTL001 provides Gain and Brightness control to adjust the contrast and brightness of output color by programming the gain and brightness coefficients. This adjustment is applied to RGB colors individually. Auto-white balance can be achieved by using this function.

### 3.2.3 Gamma Correction

Gamma Correction is used to compensate the non-linearity of LCD display panel. MTL001 contains an 8/10-bit Gamma table to fix this phenomenon. The 10-bit Gamma Table performs a better output quality, and is commonly used together with dithering function. A traditional 8-bit Gamma correction table can also be used.

### 3.2.4 Color Dithering

MTL001 supports true color (8 bits per color) or high color (6 bits per color) display. In the latter case, users can turn on dithering function to avoid artificial contour due to truncation. The dithering function works in two modes:

- ⌘ **Static dithering:** Dithering coefficient is fixed.
- ⌘ **Temporal dithering:** Dithering coefficient is time dependent.

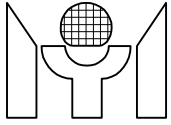

### 3.3 Output Processor

#### General Description

Output processor provides the interface for both LCD panel and OSD controller. MTL001 can work for frame-buffer or non-frame-buffer mode. When in frame-buffer mode, there is no restriction between the timing of input and output. When in non-frame-buffer mode, output frame rate must be equal to input frame rate and output display time must be equal to input display time due to the absence of frame buffer. Some features based on using the frame buffer do not work in non-frame-buffer mode, for example the screen write, static mode in de-interlace etc.

#### 3.3.1 Display Timing Generation

There are three display timing modes:

- ̂ **Frame-buffer Mode:** is used for frame rate conversion. External frame buffer is needed.
- ̂ **Non-frame-buffer Mode:** performs a low cost version of solution where the external frame buffer is not needed. This mode is used in the condition that output frame rate is equal to input frame; some features are disabled in this mode.
- ̂ **Frame SYNC Mode:** is used for video input. In this mode, output frame is synchronized to input frame, gives the moving picture a smooth change.

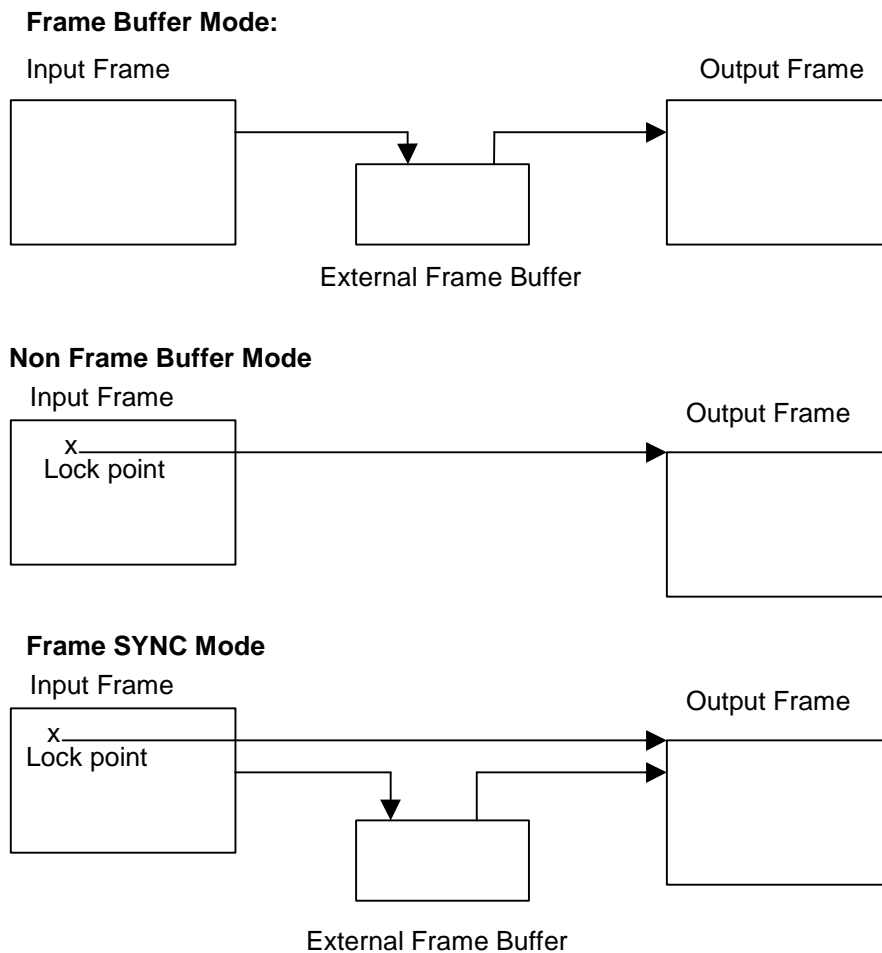
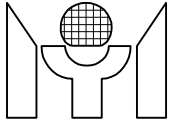

Fig. 3.2.3 Display Timing modes



### 3.3.2 OSD Overlay

MTL001 allows the integration of overlay data with the scaled output pixel stream. It provides a fully compatible OSD interface. Individual OSD clock, OSD HSYNC and OSD VSYNC are sent to external OSD device. MTL003 receives OSD Enable, OSD Red, OSD Green, OSD Blue, and OSD Intensity from external OSD device.

### 3.3.3 RGB Output Format

MTL001 output interface consists of two pixel ports, each containing Red, Green, and Blue color information with a resolution of 6/8 bits per color. These two ports are PORT1 and PORT2 respectively. The control signals for output port are the display horizontal sync signal (DHSYNC), the display vertical sync signal (DVSYNC) and the display data enable signal (DDEN).

All the signals mentioned above are synchronous to the output clock. The output timing relative to the active edge of the output clock is programmable.

There are two RGB output formats:

#### Single Pixel Mode

Is designed to support TFT panels with single pixel input. Only PORT1 is active. The frequency of DCLK1 is equal to the internal display clock.

#### Dual Pixel Mode

Is designed to support TFT panels with dual pixel input. PORT1 and PORT2 are used. The first pixel is at PORT1, and the second at PORT2.

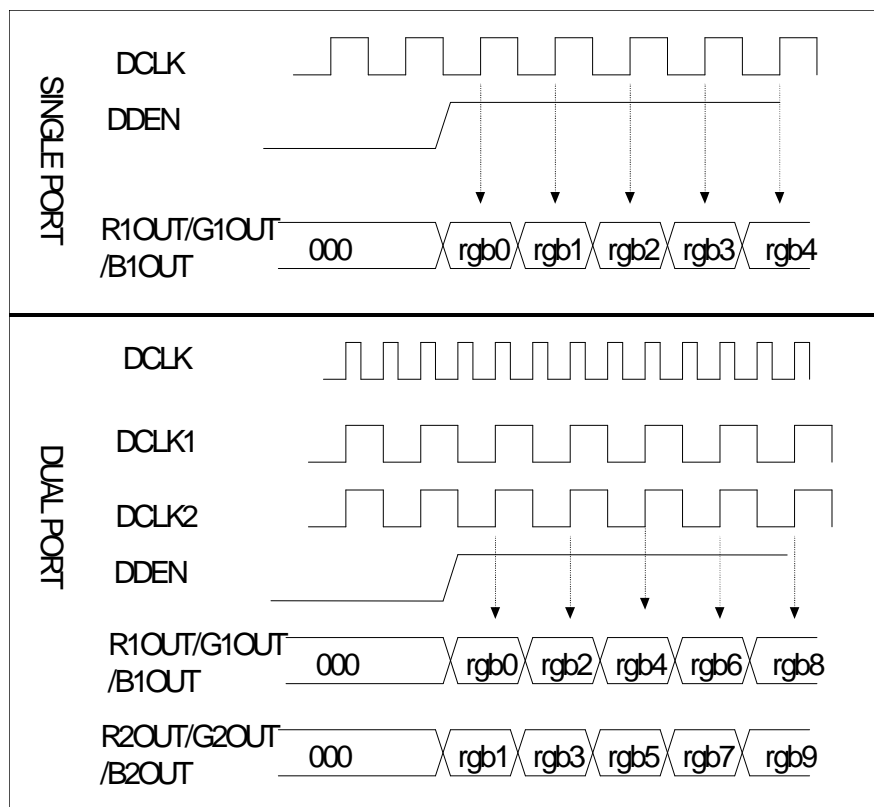
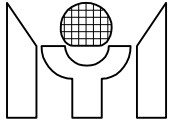

Fig. 3.2.4 Display Data Timing



### 3.4 Memory Interface

#### General Description

In frame buffer mode, the MTL001 connects to the external frame buffers by means of memory interface. The external frame memory can be made for 1MF 16bits SDRAM, 256KF 32bits or 512KF 32bits SGRAM devices. Due to different applications such as VGA, SVGA, XGA as well as SXGA, the image resolution of input and output will be limited resulting from the bandwidth of memory interface. Two configurations with 24, 32 and 48 bits bus modes will be supported to resolve the bandwidth constraint in most of applications. The clock for external frame memory devices can be provided from the internal PLL circuit or the external clock applied to pin EXTMCLK and its frequency can be up to 118 MHz. The MTL001 also supplies a simple and complete memory self-testing mechanism for SDRAM and SGRAM, which can be used to detect memory cell status and to check connection in memory interface.

#### 3.4.1 SDRAM Configuration

In current applications, the most popular arrangement of SDRAM is 1MF 16bits. To achieve the desired bandwidth in memory interface, 2 or 3 devices are constructed in parallel. The memory clock ranging from 50MHz to 118MHz is tuned by giving appropriate parameters for the internal PLL circuit. In two devices configuration, the 24 and 32 bits bus modes are supported. In three devices, the 48 bits bus mode is supported. In 24 bits bus mode, the maximum supported input image resolution is up to 1024F 768 @ 60Hz. In 32 and 48 bits bus mode, the maximum supported input image resolution is up to 1024F 768 @ 85Hz. Table 3.4.1 gives the configuration for different input and output image format. Figure 3.4.1 shows the connection between the MTL001 and SDRAM devices in 2 configurations.

Unit: device

Output Resolution \ Input Resolution	SVGA	XGA
YUV	2	2
VGA (640F 480)	2	2
SVGA (800F 600)	2	2
XGA (1024F 768)	2	2

Table 3.4.1 SDRAM configuration in different input and output modes

#### 3.4.2 SGRAM Configuration

The SGRAM devices in 256KF 32bits and 512KF 32bits constructions are usually used to feature the wide data bus for high speed applications. In case of SGRAM usage, the 32 bits data bus of each device is divided into 2 parts to store input image data. The memory clock is adjustable to achieve the desired range of performance like the SDRAM case above. The maximum supported input image resolution in 24 bits bus mode (2 devices) is up to 800F 600 @ 85Hz, and both the 32 bits bus mode (2 devices) and the 48 bits bus mode (3 devices) can support maximum input image resolution up to 1024F 768 @ 85Hz. Table 3.4.2 provides the configuration for different input and output image format. Figure 3.4.2 and 3.4.3 show the connection between the MTL001 and SGRAM devices in 2 configurations by 256KF 32bits and 512KF 32bits constructions respectively.

Unit: device

Output Resolution \ Input Resolution	SVGA	XGA
YUV	2	2
VGA (640F 480)	2	2
SVGA (800F 600)	2	2
XGA (1024F 768) (512Kx32 bits / 256Kx32 bits)	2 / 3	2 / 3

Table 3.4.2 SGRAM configurations in different input and output modes

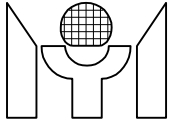

**SDRAM(1MF 16bits) F 2**

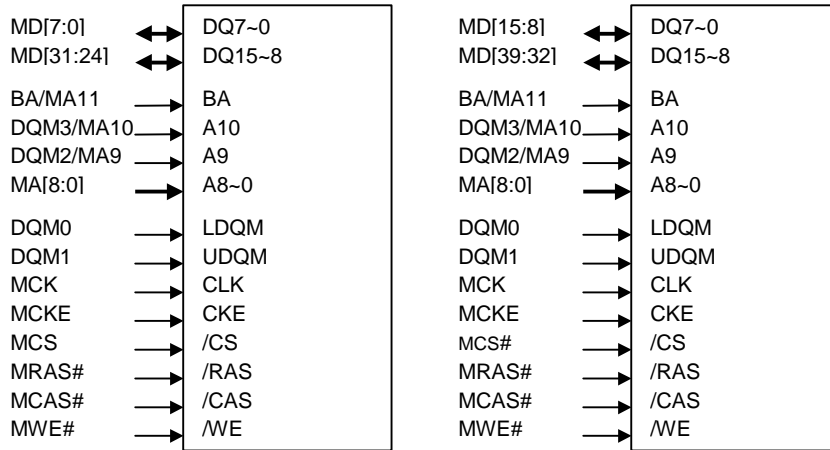

**SDRAM(1MF 16bits) F 3**

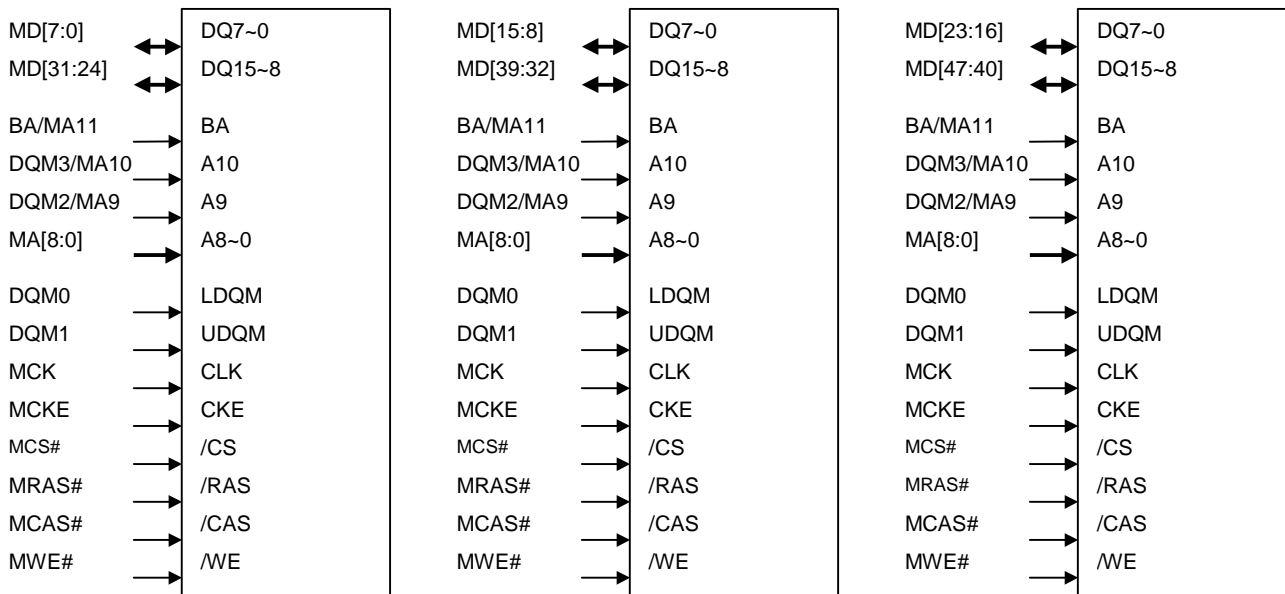
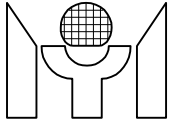
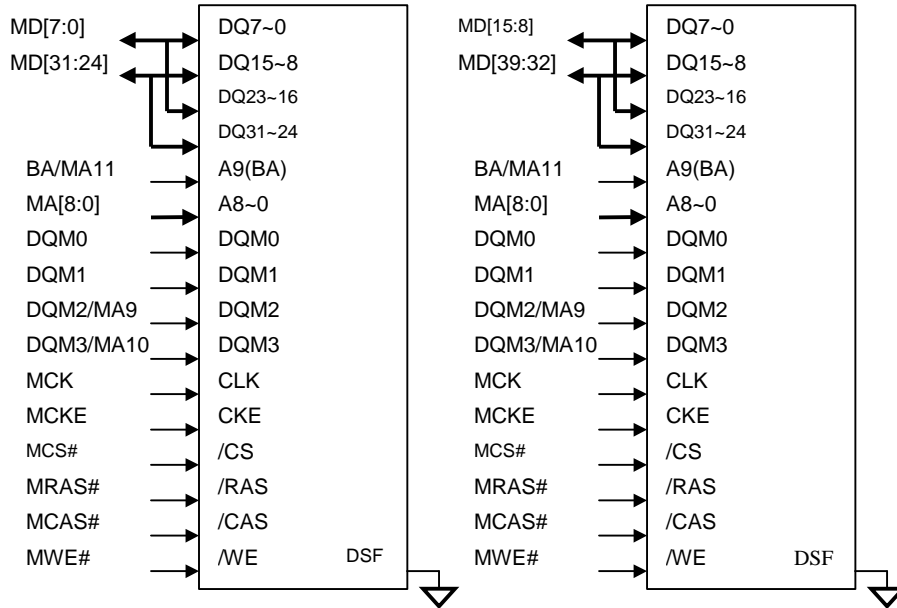

Fig. 3.4.1 The interface between MTL001 and 1Mx16 bits SDRAM



SGRAM(128KF 32bitsF 2 ) F 2



SGRAM(128KF 32bitsF 2 ) F 3

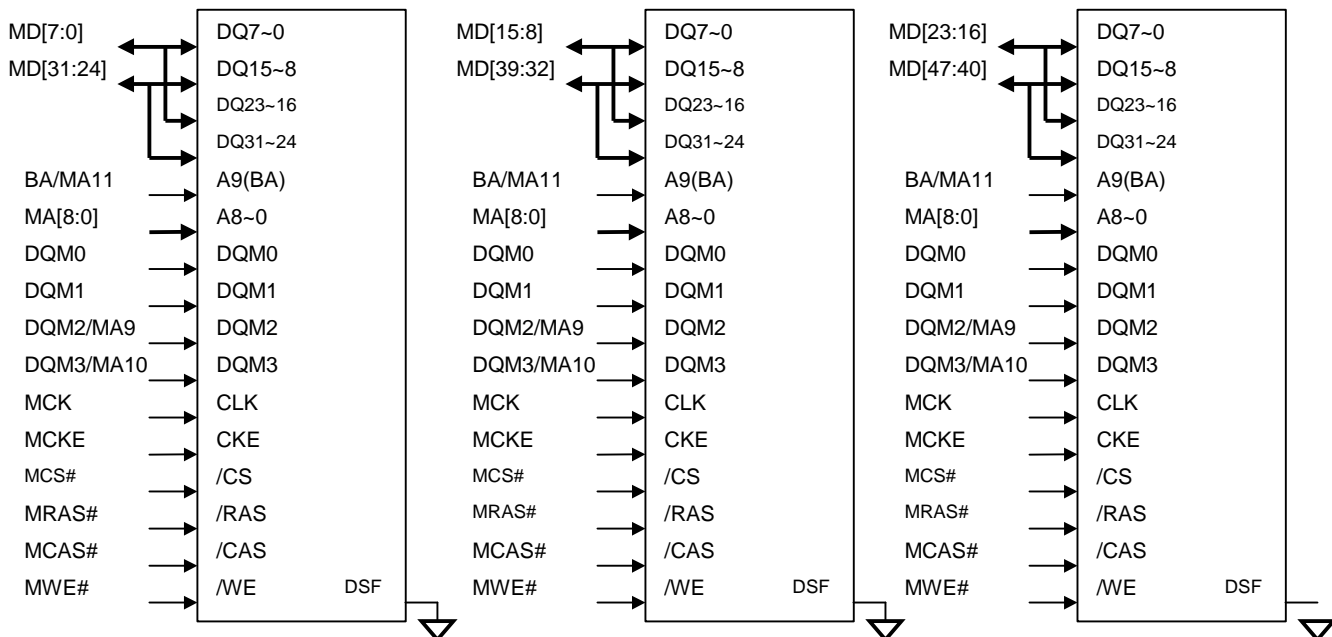

Fig. 3.4.2 The interface between MTL001 and 256Kx32 bits SGRAM

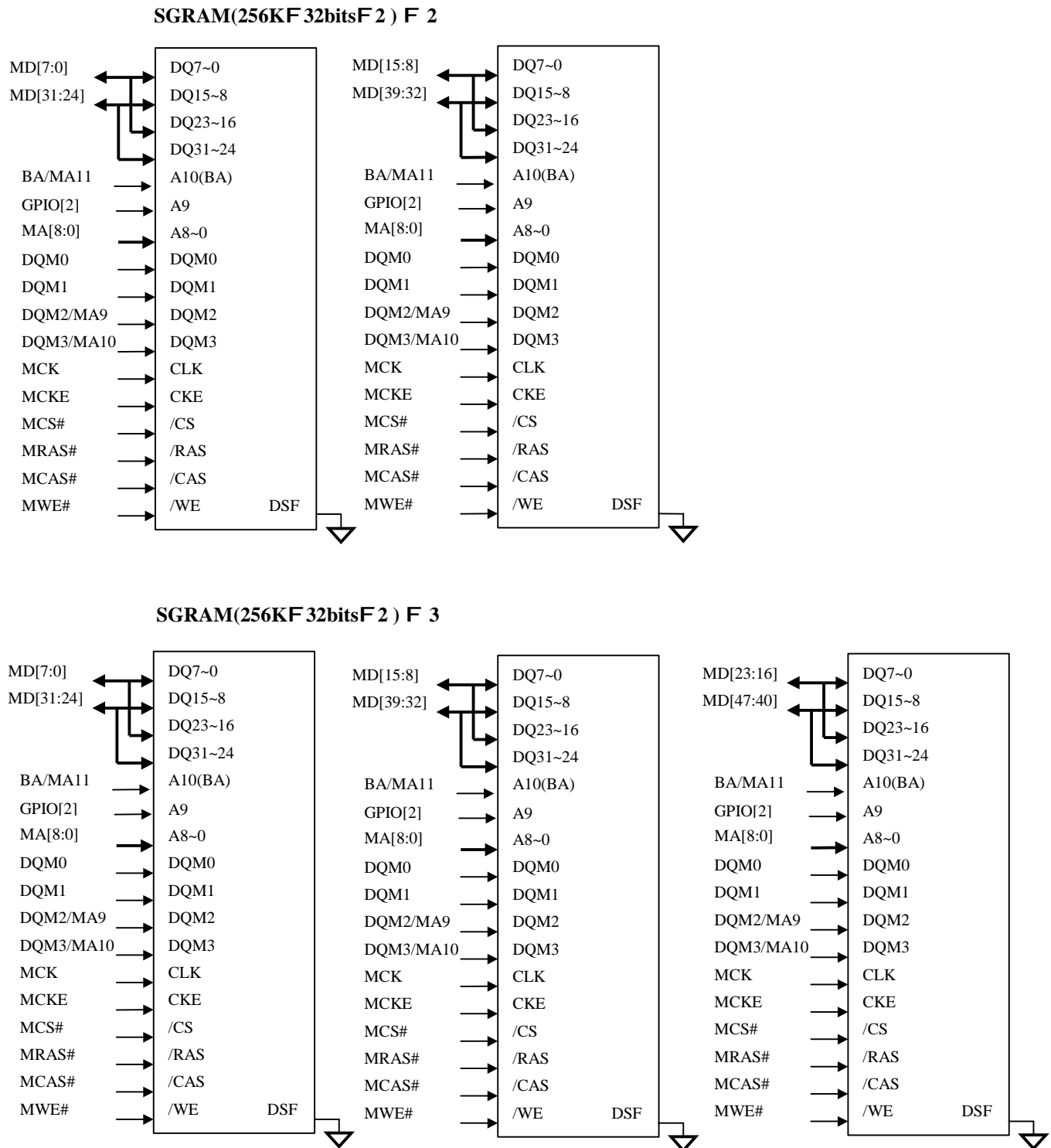
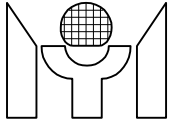

Fig. 3.4.3 The interface between MTL001 and 512Kx32 bits SGRAM





### 3.5 Host Interface

#### General Description

The primary function of Host Interface is to provide the interface between MTL001 and external CPU by 2-wire I<sup>2</sup>C Bus or Direct Bus selected by the input pin BUSSEL. It can generate all the I/O decoded control timing to control all the registers in MTL001. The other function is Screen Write, which allows users to clear frame buffer, and display output as well.

#### 3.5.1 I<sup>2</sup>C Serial Bus

The I<sup>2</sup>C serial interface uses 2 wires, SCK (clock) and SDA(data I/O) respectively. The SCK is used as the sampling clock and SDA is a bi-directional signal for the data. The communication must be started with a valid START condition, concluded with STOP condition and acknowledged by ACK condition by the receiver.

The I<sup>2</sup>C bus device address of MTL001 is 0111010x.

AD[0] SCK, serial bus clock.  
AD[1] SDA, bi-directional serial bus data.

The START condition means a HIGH to LOW transition of SDA when SCK is high, the STOP condition means a LOW to HIGH transition of SDA when SCK is high. And data of SDA can only change when SCK is low. Ref. Fig.3.5.1.

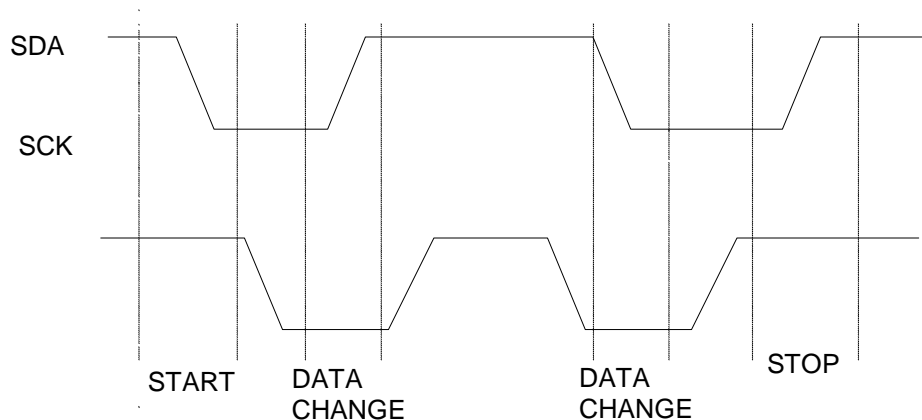

Fig. 3.5.1 START, STOP ,and DATA definition

The I<sup>2</sup>C interface supports Random Write, Sequential Write, Current Address Read, Random Read and Sequential Read operations.

#### Å Random Write

For Random Write operation, it contains the slave address with R/W bit set to 0 and the word address which is comprised of 8 bits that provides the access to any one of the 256 bytes in the selected memory range. Upon receipt of the word address, MTL003 responds with an Acknowledge and waits for the next eight bits of data again, responding with an Acknowledge, and then the master generates a stop condition. Ref. Fig.3.5.2.

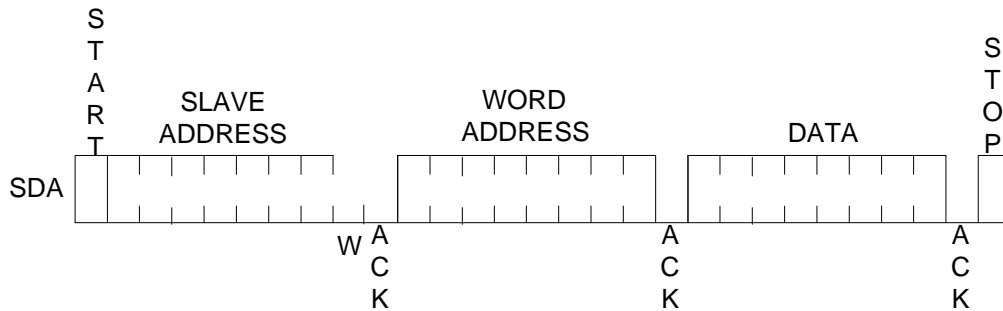
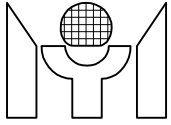

Fig. 3.5.2 Random Write

**Sequential Write**

The initial step of Sequential Write is the same as Random Write, after the receipt of each word data, MTL001 will respond with an Acknowledge and then internal address counter will increment by one for next data write. If the master stops writing data, it will generate stop condition. Ref. Fig. 3.5.3.

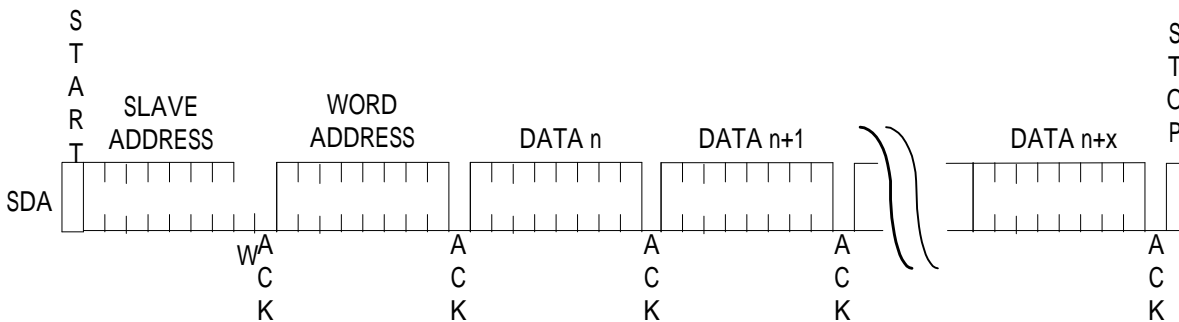

Fig. 3.5.3 Sequential Write

**Current Address Read**

MTL001 contains an address counter which maintains the last access address incremented by one. If the last access address is n, the read data should access from address n+1. Upon receipt of the slave address with R/W bit set to 1, MTL001 generates an Acknowledge and transmits the eight bits data. After receiving data the master will generate a stop condition instead of an Acknowledge. Ref. Fig. 3.5.4.

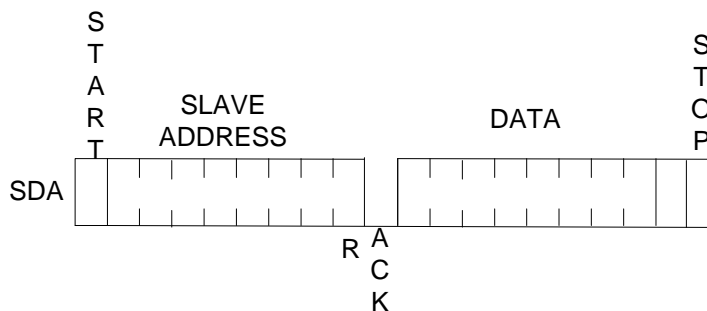
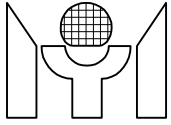

Fig. 3.5.4 Current Address Read



**Random Read**

The operation of Random Read allows access to any address. Before the reading data operation, it must issue a “dummy write” operation — the master issues the start condition, slave address and then the word address it is to read. After the word address acknowledge, the master generating a start condition again and slave address with R/W bit is set to 1. MTL001 then transmits the 8 bits of data. Upon the completion of receiving data, the master will generate a stop condition instead of an Acknowledge. Ref. Fig 3.5.5.

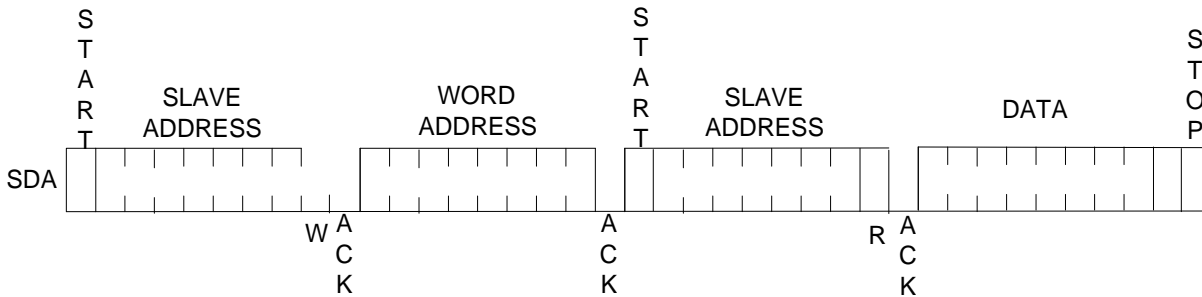

Fig. 3.5.5 Random Read

**Sequential Read**

The initial step can be as either Current Address Read or Random Read. The first read data is transmitted in the same manner as other read methods. However, the master generates an Acknowledge indicating that it requires more data to read. MTL001 continues to output data for each Acknowledge received. The output data is sequential and the internal address counter increments by one for next read data. Ref. Fig. 3.5.6.

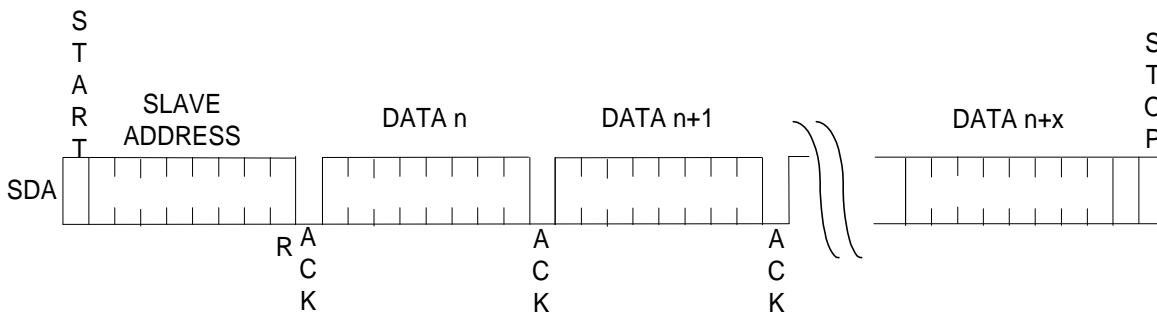

Fig. 3.5.6 Sequential Read

**3.5.2 8-bit Direct Bus**

The Direct Bus use AD[7:0], HWR#, HRD#, ALE, HCS# as the interface with host. ALE is used to latch read or write address from AD[7:0] and HRD#, HWR# to access data. Ref. Fig. 3.5.7.

- AD[7:0] Address and data multiplex bus.
- HRD# CPU read data strobe, Active Low.
- HWR# CPU write data strobe, Active Low.
- ALE ALE =1 latch read or write address, ALE=0 represents I/O data.
- HCS# Enable signal for CPU access, Active Low.

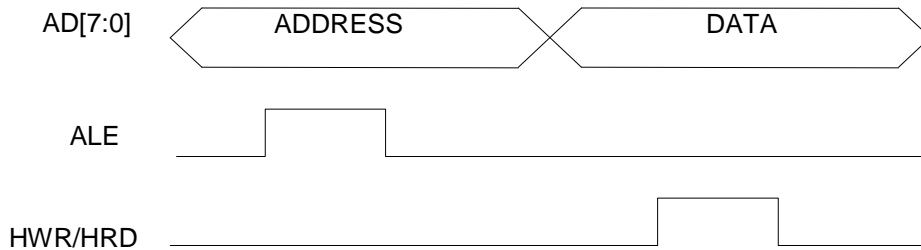
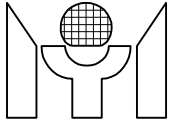

Fig. 3.5.7 Direct Bus Timing

### 3.5.3 Interrupt

MTL001 supports one interrupt output signal (IRQ) which can be programmed to provide SYNC related or function status related interrupts to the system. Upon receiving the interrupt request, Firmware needs to firstly check the interrupt event by reading the Interrupt Flag Control registers (Reg. E8h and E9h) to decide what events are happening. After the operation is completed, Firmware needs to clear interrupt status by writing the same registers Reg. E8h and E9h. Furthermore, by using the Interrupt Flag Enable registers (Reg. EAh and EBh), each interrupt event can be masked.

### 3.5.4 Screen Write

Screen Write function can be used to clear frame buffer memory and display output by a fixed value defined in Reg. C6h, C7h, C8h.

### 3.5.5 Bi-directional GPIO

MTL001 supports eight General Purpose Input and Output (GPIO) pins GPIO[7:0] on chip. The GPIO[5:0] pins are bi-directional GPIO pins, and the GPIO[7:6] pins are output only GPIO pins. There are two functions for GPIO[7:6] pins. One is to set them as output only GPIO pins, and the other is to set them as Composite decoded VSYNC/HSYNC for A/D converters in VGA input path. The data and I/O direction of GPIO[7:0] pins are controlled by Reg. F4h and F5h respectively, and each bit in the register is mapped to GPIO[7:0] correspondingly. The following description is the process to control GPIO[0] and GPIO[6] in detail, and the control processes of GPIO[4:1] and GPIO[7] also follows in the same manner.

#### ̄ Bi-directional GPIO control process

- Setting Reg. F5h/D0 = 0 or 1 to assign GPIO[0] as output or input.
- Writing data to Reg. F4h/D0 when GPIO[0] is assigned to output status, otherwise reading data from Reg. F4h/D0 when GPIO[0] is input.

#### ̄ Output only GPIO control process

- Setting Reg. F5h/D6 = 0 or 1 to assign GPIO[6] as output or tri-state.
- Setting Reg. F6h/D0 = 0 to select output source from Reg. F4h/D6 or setting it as 1 to make GPIO[6] pin to output ADHS which is HSYNC signal decoded from VGA input Composite signal by the MTL001.
- Writing data to F4h/D6 when GPIO[6] is assigned to output only GPIO pin, that is, F6h/D0 = 0 and F5h/D6 = 0. If F6h/D0 is set to 1, the GPIO[6] pin outputs ADHS for AD converters in VGA input path.

### 3.5.6 Update Register Contents

I/O write operation to some consecutive register set can have the “Double Buffer” effect by setting the Reg. C1h/D4. Written data is first stored in an intermediate bank of latches and then transferred to the active register set by setting Reg. C1h/D1-0.

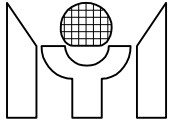

---

---

### 3.6 On-Chip PLL

#### General Description

The MTL001 needs three clock sources to drive synchronous circuits on chip. These clocks are generated from the internal Phase Lock Loop (PLL) circuits with reference to the oscillator clock which is applied to pin XI and XO by an external quartz crystal at 14.31818 MHz. First one is the same as to the oscillator clock at frequency (14.31818 MHz) to detect and measure graphic vertical and horizontal SYNC Frequency, Polarity as well as Presence. The second is memory clock to synchronize memory controller with the external frame buffers. The third is the display clock for display controller on chip and output signals to LCD panel.

#### 3.6.1 Reference Clock

It is the counting basis of counter values in SYNC Processor such as VS and HS period count registers; that is, the read back values from these registers must multiply the period of this clock to estimate VS and HS frequency. Incorporating with polarity and frequency information of VS and HS, it can show the input graphic image mode and pixel clock frequency.

#### 3.6.2 Memory Clock

This clock is the synchronous clock for the external frame buffer. Depending on the bandwidth needed by the applications, DRAM types and configurations, the memory clock changes from 50 MHz to 118 MHz by means of adjusting a set of appropriate values for M, N as well as R. The formula for calculating the desired frequency of memory clock is as follows:

$$f_{mclk} = f_{osc} F (M+2)/(N+2) F 1/R$$

Where

- $f_{mclk}$  : the desired memory clock
- $f_{osc}$  : oscillator clock with 14.31818 MHz
- M : post-divider ratio
- N : pre-divider ratio
- R : optional divider ratio

#### 3.6.3 Display Clock

This clock is the synchronous clock for LCD panel. According to the LCD panel resolution of applications, the display clock range is from 50 MHz to 100 MHz by means of choosing a set of appropriate values for M, N as well as R. The computing formula is exactly the same as for the memory clock.

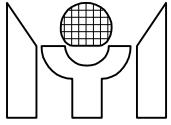

#### 4. REGISTER DESCRIPTION

##### INPUT CONTROL REGISTERS

Address	Mode	Registers	Reset value
00h	R/W	Input Image Vertical Active Line Start - Low	00h
01h	R/W	Input Image Vertical Active Line Start - High	00h
02h	R/W	Input Image Vertical Active Lines - Low	00h
03h	R/W	Input Image Vertical Active Lines - High	00h
04h	R/W	Input Image Horizontal Active Pixel Start - Low	00h
05h	R/W	Input Image Horizontal Active Pixel Start - High	00h
06h	R/W	Input Image Horizontal Active Pixels - Low	00h
07h	R/W	Input Image Horizontal Active Pixels - High	00h
10h	R/W	Input Image Control Register 0	00h
11h	R/W	Input Image Control Register 1	00h
12h	R/W	Input Image Control Register 2	00h
13h	R/W	Input Image Control Register 3	00h
14h	R/W	Input Image Control Register 4	00h
15h	R/W	Input Image Control Register 5	00h
16h	R/W	Input Image Control Register 6	00h
1Ah	R/W	Input Delay Control 2	00h
1Ch	R/W	HS1 Sample Window Forward Extend	00h
1Dh	R/W	HS1 Sample Window Backward Extend	00h
1Fh	RO	Input Image Status Register	-
20h	R/W	Input Image Back Porch Guard Band	00h
21h	R/W	Input Image Front Porch Guard Band	00h

##### FRAME SYNC REGISTERS

Address	Mode	Registers	Reset value
28h	R/W	Frame Sync Control	00h
2Ch	R/W	Input Image Vertical Lock Position - Low	00h
2Dh	R/W	Input Image Vertical Lock Position - High	00h
2Eh	R/W	Input Image Horizontal Lock Position - Low	00h
2Fh	R/W	Input Image Horizontal Lock Position - High	00h

##### AUTO CALIBRATION REGISTERS

Address	Mode	Registers	Reset value
30h	R/W	Auto Calibration Control 0	80h
31h	R/W	Auto Calibration Control 1	00h
34h	RO	Auto Calibration RED Value - Byte 0	-
35h	RO	Auto Calibration RED Value - Byte 1	-
36h	RO	Auto Calibration RED Value - Byte 2	-
37h	RO	Auto Calibration RED Value - Byte 3	-
38h	RO	Auto Calibration GREEN Value - Byte 0	-
39h	RO	Auto Calibration GREEN Value - Byte 1	-
3Ah	RO	Auto Calibration GREEN Value - Byte 2	-
3Bh	RO	Auto Calibration GREEN Value - Byte 3	-
3Ch	RO	Auto Calibration BLUE Value - Byte 0	-
3Dh	RO	Auto Calibration BLUE Value - Byte 1	-
3Eh	RO	Auto Calibration BLUE Value - Byte 2	-
3Fh	RO	Auto Calibration BLUE Value - Byte 3	-

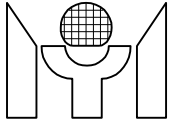

40h	R/W	Pixel Grab V Reference Position - Low	00h
41h	R/W	Pixel Grab V Reference Position - High	00h
42h	R/W	Pixel Grab H Reference Position - Low	00h
43h	R/W	Pixel Grab H Reference Position - High	00h
44h	R/W	Histogram Reference Color - RED	00h
45h	R/W	Histogram Reference Color - GREEN	00h
46h	R/W	Histogram Reference Color - BLUE	00h

**SYNC PROCESSOR REGISTERS**

Address	Mode	Registers	Reset value
48h	R/W	SYNC Processor Control	00h
49h	R/W	Auto Position Control	00h
4Ah	R/W	Auto Position Reference Color - RED	00h
4Bh	R/W	Auto Position Reference Color - GREEN	00h
4Ch	R/W	Auto Position Reference Color - BLUE	00h
4Eh	R/W	Clamp Pulse Control 0	00h
4Fh	R/W	Clamp Pulse Control 1	00h
50h	RO	Input VS Period Count by REFCLK - Low	-
51h	RO	Input VS Period Count by REFCLK - High	-
52h	RO	Input V Back Porch Count by Input HS - Low	-
53h	RO	Input V Back Porch Count by Input HS - High	-
54h	RO	Input V Active Lines Count by Input HS - Low	-
55h	RO	Input V Active Lines Count by Input HS - High	-
56h	RO	Input V Total Lines Count by Input HS - Low	-
57h	RO	Input V Total Lines Count by Input HS - High	-
58h	RO	Input HS Period Count by REFCLK - Low	-
59h	RO	Input HS Period Count by REFCLK - High	-
5Ah	RO	Input H Back Porch Count by Input Pixel Clock - Low	-
5Bh	RO	Input H Back Porch Count by Input Pixel Clock - High	-
5Ch	RO	Input H Active Pixels Count by Input Pixel Clock - Low	-
5Dh	RO	Input H Active Pixels Count by Input Pixel Clock - High	-
5Eh	RO	Input H Total Pixels Count by Input Pixel Clock - Low	-
5Fh	RO	Input H Total Pixels Count by Input Pixel Clock - High	-

**DISPLAY CONTROL REGISTERS**

Address	Mode	Registers	Reset value
60h	R/W	Display Vertical Total - Low	00h
61h	R/W	Display Vertical Total - High	00h
62h	R/W	Display Vertical SYNC End- Low	00h
63h	R/W	Display Vertical SYNC End - High	00h
64h	R/W	Display Vertical Active Start - Low	00h
65h	R/W	Display Vertical Active Start - High	00h
66h	R/W	Display Vertical Active End - Low	00h
67h	R/W	Display Vertical Active End - High	00h
68h	R/W	Display Vertical Border Start - Low	00h
69h	R/W	Display Vertical Border Start - High	00h
6Ah	R/W	Display Vertical Border End - Low	00h
6Bh	R/W	Display Vertical Border End - High	00h
70h	R/W	Display Horizontal Total - Low	00h



71h	R/W	Display Horizontal Total - High	00h
72h	R/W	Display Horizontal SYNC End - Low	00h
73h	R/W	Display Horizontal SYNC End - High	00h
74h	R/W	Display Horizontal Active Start - Low	00h
75h	R/W	Display Horizontal Active Start - High	00h
76h	R/W	Display Horizontal Active End - Low	00h
77h	R/W	Display Horizontal Active End - High	00h
78h	R/W	Display Horizontal Border Start - Low	00h
79h	R/W	Display Horizontal Border Start - High	00h
7Ah	R/W	Display Horizontal Border End - Low	00h
7Bh	R/W	Display Horizontal Border End - High	00h
88h	R/W	Output Image Control Register 0	00h
89h	R/W	Output Image Control Register 1	00h
8Ah	R/W	Output Image Control Register 2	00h
90h	R/W	Color Gain Control - RED	80h
91h	R/W	Color Gain Control - GREEN	80h
92h	R/W	Color Gain Control - BLUE	80h
93h	R/W	Brightness Control - RED	00h
94h	R/W	Brightness Control - GREEN	00h
95h	R/W	Brightness Control - BLUE	00h
96h	R/W	Border Window Color - RED	00h
97h	R/W	Border Window Color - GREEN	00h
98h	R/W	Border Window Color - BLUE	00h
9Eh	R/W	Dithering Table Data Port	-
9Fh	R/W	Gamma Table Data Port	-
A0h	R/W	OSD Control Register 0	08h
A1h	R/W	OSD Control Register 1	00h
A2h	R/W	OSD Control Register 2	00h
A4h	R/W	Output Invert Control	00h
A5h	R/W	Output Tri-State Control	00h
A6h	R/W	Output Clocks Delay Adjustment	00h
A7h	R/W	Output Clocks Duty Cycle Adjustment	00h
A9h	R/W	Output Miscellaneous Control	00h
AAh	R/W	Output Vertical Line Number - Low	FFh
ABh	R/W	Output Vertical Line Number - High	02h
ACh	RO	Output Horizontal Total Pixel Number – Low	-
ADh	RO	Output Horizontal Total Pixel Number – High	-
A Eh	RO	Output Horizontal Total Residue Number – Low	-
AFh	RO	Output Horizontal Total Residue Number - High	-

**ZOOM CONTROL REGISTERS**

Address	Mode	Registers	Reset value
B0h	R/W	Zoom Control Register 0	00h
B1h	R/W	Zoom Control Register 1	00h
B2h	R/W	Zoom Vertical Scale Down Integer	00h
B3h	R/W	Zoom Horizontal Scale Down Integer	00h
B4h	R/W	Zoom Vertical Scale Ratio - Low	00h
B5h	R/W	Zoom Vertical Scale Ratio - High	00h
B6h	R/W	Zoom Horizontal Scale Ratio - Low	00h
B7h	R/W	Zoom Horizontal Scale Ratio - High	00h



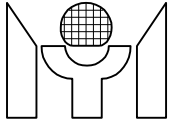

BfH	R/W	Interpolation Table Data Port	-
-----	-----	-------------------------------	---

**HOST CONTROL REGISTERS**

Address	Mode	Registers	Reset value
C0h	R/W	Host Control Register 0	00h
C1h	R/W	Host Control Register 1	00h
C4h	R/W	Host Screen Write Line Length - Low	00h
C5h	R/W	Host Screen Write Line Length - High	03h
C6h	R/W	Host Fill Color - RED	00h
C7h	R/W	Host Fill Color - GREEN	00h
C8h	R/W	Host Fill Color - BLUE	00h
CBh	RO	Host Access Mode Status	-

**MEMORY CONTROL REGISTERS**

Address	Mode	Registers	Reset value
D0h	R/W	Memory Type Control	00h
D2h	R/W	Memory Self Test Control	00h
D4h	R/W	Memory Line Offset - Low	00h
D5h	R/W	Memory Line Offset - High	04h
DBh	RO	Memory Self-Test Compare Error Address - Low	-
DCh	RO	Memory Self-Test Compare Error Address - Middle	-
DDh	RO	Memory Self-Test Compare Error Address - High	-

**CLOCK CONTROL REGISTERS**

Address	Mode	Registers	Reset value
E0h	R/W	Clock Control Register	00h
E1h	WO	Clock Synthesizer Value Load	-
E2h	R/W	Display Clock Synthesizer N Value	0Bh
E3h	R/W	Display Clock Synthesizer M Value	32h
E4h	R/W	Memory Clock Synthesizer N Value	0Bh
E5h	R/W	Memory Clock Synthesizer M Value	32h
E6h	R/W	Clock Synthesizer R Value	00h

**INTERRUPT CONTROL REGISTERS**

Address	Mode	Registers	Reset value
E8h	R/W	SYNC Interrupt Flag Control	00h
E9h	R/W	General Interrupt Flag Control	00h
EAh	R/W	SYNC Interrupt Enable	00h
EBh	R/W	General Interrupt Enable	00h
ECh	R/W	HS Frequency Change interrupt Compare	00h

**MISCELLANEOUS REGISTERS**

Address	Mode	Registers	Reset value
F1h	R/W	Power Management Control	00h
F4h	R/W	GPIO Control Register	00h
F5h	R/W	GPIO Direction Control	00h
F6h	R/W	GPIO Misc Control	00h

**Input Image Vertical Active Line Start - Low (Address 00h) (R/W)**

It defines the low byte of the start position of the Vertical Active Window.

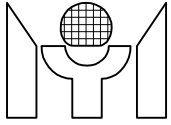

D7-0 IV\_ACT\_START[7:0]

**Input Image Vertical Active Line Start - High (Address 01h) (R/W)**

It defines the high byte of the start position of the Vertical Active Window.

D7-3 Reserved

D2-0 IV\_ACT\_START[10:8]

**Input Image Vertical Active Lines - Low (Address 02h) (R/W)**

It defines the low byte of the number of active lines of the Vertical Active Window.

D7-0 IV\_ACT\_LEN[7:0]

**Input Image Vertical Active Lines - High (Address 03h) (R/W)**

It defines the high byte of the number of active lines of the Vertical Active Window.

D7-3 Reserved

D2-0 IV\_ACT\_LEN[10:8]

**Input Image Horizontal Active Pixel Start - Low (Address 04h) (R/W)**

It defines the low byte of the start position of the Horizontal Active Window.

D7-0 IH\_ACT\_START[7:0]

**Input Image Horizontal Active Pixel Start - High (Address 05h) (R/W)**

It defines the high byte of the start position of the Horizontal Active Window.

D7-3 Reserved

D2-0 IH\_ACT\_START[10:8]

**Input Image Horizontal Active Pixels - Low (Address 06h) (R/W)**

It defines the low byte of the number of active pixels of the Horizontal Active Window.

D7-0 IH\_ACT\_WIDTH[7:0]

**Input Image Horizontal Active Pixels - High (Address 07h) (R/W)**

It defines the high byte of the number of active pixels of the Horizontal Active Window.

D7-3 Reserved

D2-0 IH\_ACT\_WIDTH[10:8]

**Input Image Control Register 0 (Address 10h) (R/W)**

D7 Horizontal Sampling Point Reference  
0: from Input HSYNC.

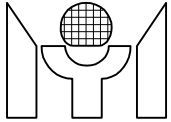

1: from Input HREF (only for Video Decoder).

D6	Input YCBCR Format 0: 4-2-2 1: 4-1-1
D5	Digital RGB 6 bit Mode 0: 8 bits 1: 6 bits
D4	Digital RGB Mode Select 0: RGB Input from ADC 1: RGB Input from Panel Link
D3	Input Image Format 0: RGB888 1: YCBCR
D2	Input Clock Source 0: from Graphic PLL clock. 1: from Video Decoder clock.
D1	Input Image Source 0: from Graphic source through ADC. 1: from Video source through Video Decoder like SAA7111A.
D0	ADC Configuration 0: Double Pixel mode 1: Single Pixel mode

### **Input Image Control Register 1 (Address 11h) (R/W)**

D7	Reserved
D6-4	De-interlace mode Select 000: All Fields write mode 001: Toggle Field write mode 010: Spatial Filtering write mode
D3	Input YUV CCIR656 Format 0: Disable 1: Enable
D2-1	Reserved
D0	Still mode Enable 0: Live mode 1: Still mode

### **Input Image Control Register 2 (Address 12h) (R/W)**

D7	Input ODD Field Invert 0: Normal 1: Invert
D6	External Input Interlace Select 0: Non-interlace

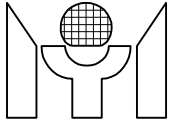

1: Interlace

- D5 External Input VSYNC Polarity  
0: Active Low  
1: Active High
- D4 External Input HSYNC Polarity  
0: Active Low  
1: Active High
- D3 Input ODD Field Source  
0: from Internal Detection  
1: from External pin.
- D2 Input Interlace Source  
0: from Internal detection  
1: from Register setting (D6)
- D1 Input VSYNC Polarity Source  
0: from Internal detection  
1: from Register setting (D5)
- D0 Input HSYNC Polarity Source  
0: from Internal detection  
1: from Register setting (D4)

### **Input Image Control Register 3 (Address 13h) (R/W)**

- D7 Active Position Area for Auto Position in TMDS  
0: from Internal Detection  
1: from External Data Enable (TDIE)
- D6-3 Reserved
- D2 Sync On Green Select  
0: Select Normal HSYNC/ Composite Sync  
1: Select Sync On Green
- D1 Input Vertical Timing based on VSYNC  
0: Leading Edge  
1: Trailing Edge
- D0 Input Horizontal Timing based on HSYNC  
0: Leading Edge  
1: Trailing Edge

### **Input Image Control Register 4 (Address 14h) (R/W)**

- D7 Input ODD Field Detection Point  
0: at the start of VSYNC pulse.  
1: at the end of VSYNC pulse.
- D6 Input Image Port A, B Data and Clocks Swap  
0: Normal  
1: Swap
- D5 Reserved

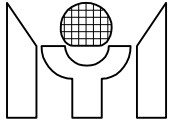

D4 Input Image CBCR Order Swap  
0: Normal  
1: Swap

D3-0 Reserved

**Input Image Control Register 5 (Address 15h) (R/W)**

D7 Horizontal Pixel Valid Select  
0: from Internal Programming  
1: from External HREF/TDIE

D6-0 Reserved

**Input Image Control Register 6 (Address 16h) (R/W)**

D7-3 Reserved

D2 ADC HS Polarity Invert when D1=1  
0: Active Low  
1: Active High

D1 Raw HS path Enable  
0: Disable  
1: Enable

D0 Reserved

**Input Delay Control 2 (Address 1Ah) (R/W)**

D7-4 Input VSYNC Delay Adjustment  
1111: 7 IDCLKs delay  
1110: 6 IDCLKs delay  
1101: 5 IDCLKs delay  
1100: 4 IDCLKs delay  
1011: 3 IDCLKs delay  
1010: 2 IDCLKs delay  
1001: 1 IDCLK delay  
1000: Reserved  
0111: 7ns gate delay  
0110: 6ns gate delay  
0101: 5ns gate delay  
0100: 4ns gate delay  
0011: 3ns gate delay  
0010: 2ns gate delay  
0001: 1ns gate delay  
0000: No delay

D3-0 Input HSYNC Delay Adjustment  
16 steps to change, each of them is 1ns delay/step.

**Input HS Pulse Width Forward Extend (Address 1Ch) (R/W)**

D7-0 Input HS Pulse Width Forward Extend by IDCLK  
HS1FWEXT[7:0]: Used when Interlace First/Second Field Detection.

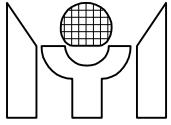

**Input HS Pulse Width Backward Extend (Address 1Dh) (R/W)**

D7-0 Input HS Pulse Width Backward Extend by IDCLK  
HS1BWEXT[7:0]: Used when Interlace First/Second Field Detection.

**Input Image Status Register (Address 1Fh) (RO)**

D7 Display VSYNC Monitor  
Show Display VSYNC signal directly.

D6 Input VSYNC Monitor  
Show Input VSYNC signal directly.

D5 External Input Interlace Status  
0: Non-interlace  
1: Interlace

D4 Extracted CVSINC Present Status  
0: Not Present  
1: Present

D3 External Input VSYNC Present Status  
0: Not Present  
1: Present

D2 External Input HSYNC Present Status  
0: Not Present  
1: Present

D1 External Input VSYNC Polarity Status  
0: Active Low  
1: Active High

D0 External Input HSYNC Polarity Status  
0: Active Low  
1: Active High

**Input Image Back Porch Guard Band (Address 20h) (R/W)**

D7-0 Input Image Back Porch Guard Band by IDCLK  
HBPGB[7:0]: Used in Auto Position detection to mask out unwanted data.

**Input Image Front Porch Guard Band (Address 21h) (R/W)**

D7-0 Input Image Front Porch Guard Band by IDCLK  
HFPGB[7:0]: Used in Auto Position detection to mask out unwanted data.

**Frame Sync Control 0 (Address 28h) (R/W)**

D7-5 Reserved

D1 Frame Sync Select in Frame Buffer mode  
0: Normal  
1: Frame Sync

D0 Frame Buffer mode Select  
0: Frame Buffer mode

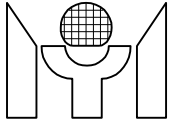

1: Non Frame Buffer mode

### **Input Image Vertical Lock Position - Low (Address 2Ch) (R/W)**

It defines the low byte of the number of input lines where Display image timing synchronizes the input image source.

D7-0            IPV\_LOCK\_POS[7:0]

### **Input Image Vertical Lock Position - High (Address 2Dh) (R/W)**

It defines the high byte of the number of input lines where Display image timing synchronizes the input image source.

D7-3            Reserved

D2-0            IPV\_LOCK\_POS[10:8]

### **Input Image Horizontal Lock Position - Low (Address 2Eh) (R/W)**

It defines the low byte of the number of input pixel clocks where Display image timing synchronizes the input image source.

D7-0            IPH\_LOCK\_POS[7:0]

### **Input Image Horizontal Lock Position - High (Address 2Fh) (R/W)**

It defines the high byte of the number of input pixel clocks where Display image timing synchronizes the input image source.

D7-3            Reserved

D2-0            IPH\_LOCK\_POS[10:8]

### **Auto Calibration Control 0 (Address 30h) (R/W)**

D7              Pixel Grab Ready Flag (**RO**)  
0: Ready  
1: Not Ready

D6              Pixel Grab Update Enable  
0: Stop updating  
1: Continue updating

D5              Threshold Select  
Used in Histogram mode or MIN/MAX mode.  
0: High bound / MAX  
1: Low bound / MIN

D4              Phase Calibration Method Select  
0: MYSON proprietary method  
1: Difference Value method

D3-2            Auto Calibration Modes Select  
The measured value is available one item at a time,  
selected as shown:  
00: Phase Calibration Mode



01: Histogram Mode  
10: MIN/MAX Mode  
11: Pixel Grab Mode

D1 Auto Calibration Burst Mode Enable  
(except Pixel Grab Mode)  
0: Single Mode  
1: Burst Mode

D0 Auto Calibration Enable **(W)**  
(except Pixel Grab Value)  
0: Disable  
1: Enable  
Auto Calibration Ready Flag **(R)**  
0: Ready  
1: Not Ready

**Auto Calibration Control 1 (Address 31h) (R/W)**

D7-3 Reserved

D2-0 Mask LSBs of Input Image Select  
It is used only for Phase Calibration to mask noise.  
000: No Mask  
001: Mask bit0  
010: Mask bit0,1  
011: Mask bit0,1,2  
100: Mask bit0,1,2,3  
101: Mask bit0,1,2,3,4  
110: Mask bit0,1,2,3,4,5  
111: Mask bit0,0,1,2,3,4,5,6

**Auto Calibration RED Value - Byte 0 (Address 34h) (RO)**

It states the byte 0 of the number of Phase Calibration RED value in one frame or the byte 0 of the number of Histogram Red value in one frame or the Pixel Grab RED value in one frame of Non\_interlace mode or FIRST field of Interlace mode.

D7-0 CALVAL\_R[7:0]

**Auto Calibration RED Value - Byte 1 (Address 35h) (RO)**

It states the byte 1 of the number of Phase Calibration RED value in one frame or the byte 1 of the number of Histogram Red value in one frame or the Pixel Grab GREEN value in one frame of Non\_interlace mode or FIRST field of Interlace mode.

D7-0 CALVAL\_R[15:8]

**Auto Calibration RED Value - Byte 2 (Address 36h) (RO)**

It states the byte 2 of the number of Phase Calibration RED value in one frame or the byte 2 of the number of Histogram Red value in one frame or the Pixel Grab BLUE value in one frame of Non\_interlace mode or FIRST field of Interlace mode.

D7-0 CALVAL\_R[23:16]

**Auto Calibration RED Value - Byte 3 (Address 37h) (RO)**



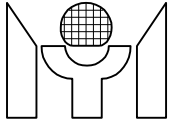

It states the byte 3 of the number of Phase Calibration RED value in one frame.

D7-6 Reserved

D5-0 CALVAL\_R[29:24]

**Auto Calibration GREEN Value - Byte 0 (Address 38h) (RO)**

It states the byte 0 of the number of Phase Calibration GREEN value in one frame or the byte 0 of the number of Histogram GREEN value in one frame or the Pixel Grab RED value in SECOND field of Interlace mode.

D7-0 CALVAL\_G[7:0]

**Auto Calibration GREEN Value - Byte 1 (Address 39h) (RO)**

It states the byte 1 of the number of Phase Calibration GREEN value in one frame or the byte 1 of the number of Histogram GREEN value in one frame or the Pixel Grab GREEN value in SECOND field of Interlace mode.

D7-0 CALVAL\_G[15:8]

**Auto Calibration GREEN Value - Byte 2 (Address 3Ah) (RO)**

It states the byte 2 of the number of Phase Calibration GREEN value in one frame or the byte 2 of the number of Histogram GREEN value in one frame or the Pixel Grab BLUE value in SECOND field of Interlace mode.

D7-0 CALVAL\_G[23:16]

**Auto Calibration GREEN Value - Byte 3 (Address 3Bh) (RO)**

It states the byte 3 of the number of Phase Calibration GREEN value in one frame.

D7-6 Reserved

D5-0 CALVAL\_G[29:24]

**Auto Calibration BLUE Value - Byte 0 (Address 3Ch) (RO)**

It states the byte 0 of the number of Phase Calibration BLUE value in one frame or the byte 0 of the number of Histogram BLUE value in one frame or the MIN/MAX RED value in one frame.

D7-0 CALVAL\_B[7:0]

**Auto Calibration BLUE Value - Byte 1 (Address 3Dh) (RO)**

It states the byte 1 of the number of Phase Calibration BLUE value in one frame or the byte 1 of the number of Histogram BLUE value in one frame or the MIN/MAX GREEN value in one frame.

D7-0 CALVAL\_B[15:8]

**Auto Calibration BLUE Value - Byte 2 (Address 3Eh) (RO)**

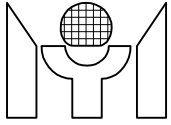

---

It states the byte 2 of the number of Phase Calibration BLUE value in one frame or the byte 2 of the number of Histogram BLUE value in one frame or the MIN/MAX BLUE value in one frame.

D7-0 CALVAL\_B[23:16]

**Auto Calibration BLUE Value - Byte 3 (Address 3Fh) (RO)**

It states the byte 3 of the number of Phase Calibration BLUE value in one frame.

D7-6 Reserved

D5-0 CALVAL\_B[29:24]

**Pixel Grab V Reference Position - Low (Address 40h) (R/W)**

It states the low byte of Vertical Reference Position in Pixel Grab Mode.

D7-0 VGRAB\_POS[7:0]

**Pixel Grab V Reference Position - High (Address 41h) (R/W)**

It states the high byte of Vertical Reference Position in Pixel Grab Mode.

D7-3 Reserved

D2-0 VGRAB\_POS[10:8]

**Pixel Grab H Reference Position - Low (Address 42h) (R/W)**

It states the low byte of Horizontal Reference Position in Pixel Grab Mode.

D7-0 HGRAB\_POS[7:0]

**Pixel Grab H Reference Position - High (Address 43h) (R/W)**

It states the high byte of Horizontal Reference Position in Pixel Grab Mode.

D7-3 Reserved

D2-0 HGRAB\_POS[10:8]

**Histogram Reference Color - RED (Address 44h) (R/W)**

It states the Histogram Reference RED Color in Histogram Mode.

D7-0 HIST\_R[7:0]

**Histogram Reference Color - GREEN (Address 45h) (R/W)**

It states the Histogram Reference GREEN Color in Histogram Mode.

D7-0 HIST\_G[7:0]

**Histogram Reference Color - BLUE (Address 46h) (R/W)**

It states the Histogram Reference BLUE Color in Histogram Mode.

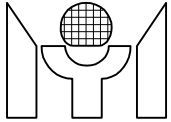

D7-0 HIST\_B[7:0]

**SYNC Processor Control (Address 48h) (R/W)**

D7-2 Reserved

D1-0 SYNC Source  
00: from H/V SYNC  
01: from CVSYNC (Composite SYNC)  
1x: Auto switch to CVSYNC when CVSYNC is present, but VSYNC not.

**Auto Position Control (Address 49h) (R/W)**

D7-2 Reserved

D1 Auto Position Burst Mode Enable  
0: Single Mode  
1: Burst Mode

D0 Auto Position Enable (**W**)  
0: Disable  
1: Enable  
Auto Position Ready Flag (**R**)  
0: Ready  
1: Not Ready

**Auto Position Reference Color - RED (Address 4Ah) (R/W)**

It defines the red component color for selecting between black and non-black pixels.

D7-0 REF\_COLOR\_RED[7:0]

**Auto Position Reference Color - GREEN (Address 4Bh) (R/W)**

It defines the green component color for selecting between black and non-black pixels.

D7-0 REF\_COLOR\_GREEN[7:0]

**Auto Position Reference Color - BLUE (Address 4Ch) (R/W)**

It defines the blue component color for selecting between black and non-black pixels.

D7-0 REF\_COLOR\_BLUE[7:0]

**Clamp Pulse Control 0 (Address 4Eh) (R/W)**

D7 Clamp Pulse Mask  
0: Normal  
1: Mask out Clamp Pulse

D6 Clamp Pulse Start Reference Edge  
0: From Input HSYNC trailing edge.  
1: From Input HSYNC leading edge.

D5 Clamp Pulse output Polarity  
0: Active High

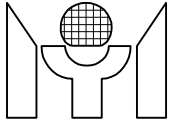

1: Active Low

D4-0 Clamp Pulse Start  
Start of Clamp Pulse after the selected edge of Input HSYNC by Input DCLK.

**Clamp Pulse Control 1 (Address 4Fh) (R/W)**

D7-5 Reserved

D4-0 Clamp Pulse Width  
To Adjust Clamp Pulse Width by Input DCLK.

**Input VS Period Count by REFCLK - Low (Address 50h) (RO)**

It states the low byte of the number of REFCLK of the Vertical Sync period measurement.

D7-0 VSPRD[7:0]

**Input VS Period Count by REFCLK - High (Address 51h) (RO)**

It states the high byte of the number of REFCLK of the Vertical Sync period measurement.

D7-4 Reserved

D3-0 VSPRD[11:8]

**Input V Back Porch Count by Input HS - Low (Address 52h) (RO)**

It states the low byte of the number of lines between the end of VSYNC and the active image.

D7-0 VBPW[7:0]

**Input V Back Porch Count by Input HS - High (Address 53h) (RO)**

It states the high byte of the number of lines between the end of VSYNC and the active image

D7-3 Reserved

D2-0 VBPW[10:8]

**Input V Active Image Count by Input HS - Low (Address 54h) (RO)**

It states the low byte of the number of the active image lines.

D7-0 VACTW[7:0]

**Input V Active Image Count by Input HS - High (Address 55h) (RO)**

It states the high byte of the number of the active image lines

D7-3 Reserved

D2-0 VACTW[10:8]

**Input V Total Image Count by Input HS - Low (Address 56h) (RO)**

It states the low byte of the number of the total image lines.

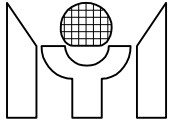

D7-0 VTOTW[7:0]

**Input V Total Image Count by Input HS - High (Address 57h) (RO)**

It states the high byte of the number of the total image lines.

D7-3 Reserved

D2-0 VTOTW[10:8]

**Input HS Period Count by REFCLK - Low (Address 58h) (RO)**

It states the low byte of the number of REFCLKs of the Horizontal Sync period measurement.

D7-0 HSPRD[7:0]

**Input HS Period Count by REFCLK - High (Address 59h) (RO)**

It states the high byte of the number of REFCLKs of the Horizontal Sync period measurement.

D7-5 Reserved

D4-0 HSPRD[12:8]

**Input H Back Porch Count by Input Pixel Clock -Low (Address 5Ah) (RO)**

It states the low byte of the number of pixels between the end of HSYNC and the active image.

D7-0 HBPW[7:0]

**Input H Back Porch Count by Input Pixel Clock -High (Address 5Bh) (RO)**

It states the high byte of the number of pixels between the end of HSYNC and the active image.

D7-3 Reserved

D2-0 HBPW[10:8]

**Input H Active Image Count by Input Pixel Clock-Low(Address 5Ch) (RO)**

It states the low byte of the number of the Horizontal active image pixels.

D7-0 HACTW[7:0]

**Input H Active Image Count by Input Pixel Clock-High(Address 5Dh)(RO)**

It states the high byte of the number of the Horizontal active image pixels.

D7-3 Reserved

D2-0 HACTW[10:8]

**Input H Total Image Count by Input Pixel Clock- Low (Address 5Eh) (RO)**

It states the low byte of the number of the Horizontal total image pixels.

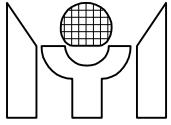

D7-0 HTOTW[7:0]

**Input H Total Image Count by Input Pixel Clock- High (Address 5Fh) (RO)**

It states the high byte of the number of the Horizontal total image pixels.

D7-3 Reserved

D2-0 HTOTW[10:8]

**Display Vertical Total - Low (Address 60h) (R/W)**

It defines the low byte of the number of lines per display frame.

D7-0 DV\_TOTAL[7:0]

**Display Vertical Total - High (Address 61h) (R/W)**

It defines the high byte of the number of lines per display frame.

D7-3 Reserved

D2-0 DV\_TOTAL[10:8]

**Display Vertical SYNC End - Low (Address 62h) (R/W)**

It defines the low byte of Vertical SYNC end position in lines.

D7-0 DV\_SYNC\_END[7:0]

**Display Vertical VSYNC End - High (Address 63h) (R/W)**

It defines the high byte of Vertical SYNC end position in lines.

D7-3 Reserved

D2-0 DV\_SYNC\_END[10:8]

Note: Display Vertical SYNC Start is always equal 0.

**Display Vertical Active Start - Low (Address 64h) (R/W)**

It defines the low byte of Vertical Active region start position in lines.

D7-0 DV\_ACT\_START[7:0]

**Display Vertical Active Start - High (Address 65h) (R/W)**

It defines the high byte of Vertical Active region start position in lines.

D7-3 Reserved

D2-0 DV\_ACT\_START[10:8]

**Display Vertical Active End - Low (Address 66h) (R/W)**

It defines the low byte of Vertical Active region end position in lines.

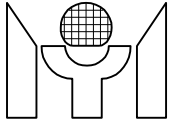

D7-0 DV\_ACT\_END[7:0]

**Display Vertical Active End - High (Address 67h) (R/W)**

It defines the high byte of Vertical Active region end position in lines.

D7-3 Reserved

D2-0 DV\_ACT\_END[10:8]

**Display Vertical Border Start - Low (Address 68h) (R/W)**

It defines the low byte of Vertical Border start position in lines.

D7-0 DV\_BOR\_START[7:0]

**Display Vertical Border Start - High (Address 69h) (R/W)**

It defines the high byte of Vertical Border start position in lines.

D7-3 Reserved

D2-0 DV\_BOR\_START[10:8]

**Display Vertical Border End - Low (Address 6Ah) (R/W)**

It defines the low byte of Vertical Border end position in lines.

D7-0 DV\_BOR\_END[7:0]

**Display Vertical Border End - High (Address 6Bh) (R/W)**

It defines the high byte of Vertical Border end position in lines.

D7-3 Reserved

D2-0 DV\_BOR\_END[10:8]

**Display Horizontal Total - Low (Address 70h) (R/W)**

It defines the low byte of the number of display clock cycles per display line.

D7-0 DH\_TOTAL[7:0]

**Display Horizontal Total - High (Address 71h) (R/W)**

It defines the high byte of the number of display clock cycles per display line.

D7-3 Reserved

D2-0 DH\_TOTAL[10:8]

**Display Horizontal SYNC End - Low (Address 72h) (R/W)**

It defines the low byte of Horizontal SYNC end position in display clock cycles.



D7-0 DH\_SYNC\_END[7:0]

**Display Horizontal SYNC End - High (Address 73h) (R/W)**

It defines the high byte of Horizontal SYNC end position in display clock cycles.

D7-3 Reserved

D2-0 DH\_SYNC\_END[10:8]

Note: Display Horizontal SYNC Start is always equal 0.

**Display Horizontal Active Start - Low (Address 74h) (R/W)**

It defines the low byte of Horizontal Active region start position in display clock cycles.

D7-0 DH\_ACT\_START[7:0]

**Display Horizontal Active Start - High (Address 75h) (R/W)**

It defines the high byte of Horizontal Active region start position in display clock cycles.

D7-3 Reserved

D2-0 DH\_ACT\_START[10:8]

**Display Horizontal Active End - Low (Address 76h) (R/W)**

It defines the low byte of Horizontal Active region end position in display clock cycles.

D7-0 DH\_ACT\_END[7:0]

**Display Horizontal Active End - High (Address 77h) (R/W)**

It defines the high byte of Horizontal Active region end position in display clock cycles.

D7-3 Reserved

D2-0 DH\_ACT\_END[10:8]

**Display Horizontal Border Start - Low (Address 78h) (R/W)**

It defines the low byte of Horizontal Border start position in display clock cycles.

D7-0 DH\_BOR\_START[7:0]

**Display Horizontal Border Start - High (Address 79h) (R/W)**

It defines the high byte of Horizontal Border start position in display clock cycles.

D7-3 Reserved

D2-0 DH\_BOR\_START[10:8]

**Display Horizontal Border End - Low (Address 7Ah) (R/W)**

It defines the low byte of Horizontal Border end position in display clock cycles.



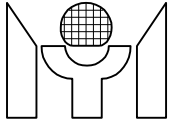

D7-0 DH\_BOR\_END[7:0]

**Display Horizontal Border End - High (Address 7Bh) (R/W)**

It defines the high byte of Horizontal Border end position in display clock cycles.

D7-3 Reserved

D2-0 DH\_BOR\_END[10:8]

**Output Image Control Register 0 (Address 88h) (R/W)**

D7-3 Reserved

D2 Output Pixel 18 bit RGB Mode Select  
0: 24 bit RGB  
1: 18 bit RGB

D1 Output Dual Pixel Data Exchange  
0: Normal  
1: Exchange

D0 Output Dual Pixel Select  
0: Dual Pixel  
1: Single Pixel

**Output Image Control Register 1 (Address 89h) (R/W)**

D7-6 Reserved

D5 RGB Brightness Control Enable  
0: Disable  
1: Enable

D4 RGB Gain Control Enable  
0: Disable  
1: Enable

D3-2 Reserved

D1 Border Window Function  
0: OFF  
1: ON

D0 Output Blank Screen  
0: Normal  
1: Output Pixel masked as BLACK color

**Output Image Control Register 2 (Address 8Ah) (R/W)**

D7 Reserved

D6 Temporal Dithering Enable  
0: Static Dithering  
1: Temporal Dithering

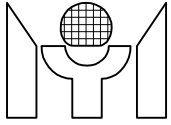

---

---

D5	Dithering Table R/W Access Enable 0: Disable 1: Enable
D4	Dithering Enable 0: Disable 1: Enable
D3	Reserved
D2	10 bit Gamma Table Enable 0: 8 bit Gamma Table 1: 10 bit Gamma Table
D1	Gamma Table R/W Access Enable 0: Disable 1: Enable
D0	Gamma Correction Function 0: OFF 1: ON

### **Color Gain Control - RED (Address 90h) (R/W)**

It can be used to adjust the gain of RED component of the Display Image.

D7-0          RGAIN[7:0]  
0(00h) ~ x1(80h) ~ x1.992185(FFh)

### **Color Gain Control - GREEN (Address 91h) (R/W)**

It can be used to adjust the gain of GREEN component of the Display Image.

D7-0          GGAIN[7:0]  
0(00h) ~ x1(80h) ~ x1.992185(FFh)

### **Color Gain Control - BLUE (Address 92h) (R/W)**

It can be used to adjust the gain of BLUE component of the Display Image.

D7-0          BGAIN[7:0]  
0(00h) ~ x1(80h) ~ x1.992185(FFh)

### **Color Brightness Control - RED (Address 93h) (R/W)**

It can be used to adjust the brightness of RED component of the Display Image.

D7-0          RBRIGHT[7:0]  
-128(80h) ~ 0(00h) ~127(7Fh)

### **Color Brightness Control - GREEN (Address 94h) (R/W)**

It can be used to adjust the brightness of GREEN component of the Display Image.

D7-0          GBRIGHT[7:0]  
-128(80h) ~ 0(00h) ~127(7Fh)

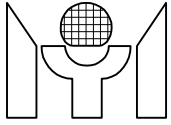

### Color Brightness Control - BLUE (Address 95h) (R/W)

It can be used to adjust the brightness of BLUE component of the Display Image.

D7-0           BBRIGHT[7:0]  
                  -128(80h) ~ 0(00h) ~127(7Fh)

### Border Window Color - RED (Address 96h) (R/W)

When the Display Image is not expanded to full screen, it can be specified as the RED component of the border color.

D7-0           BCR[7:0]

### Border Window Color - GREEN (Address 97h) (R/W)

When the Display Image is not expanded to full screen, it can be specified as the GREEN component of the border color.

D7-0           BCG[7:0]

### Border Window Color - BLUE (Address 98h) (R/W)

When the Display Image is not expanded to full screen, it can be specified as the BLUE component of the border color.

D7-0           BCB[7:0]

### Dithering Table Data Port (Address 9Eh) (R/W)

Since the Dithering Table is downloadable, this data port is the entry address.

D7-0           DITHER\_PORT[7:0]

### Gamma Table Data Port (Address 9Fh) (R/W)

Since the Gamma Table is downloadable, this data port is the entry address.

D7-0           GAMMA\_PORT[7:0]

### OSD Control Register 0 (Address A0h) (R/W)

D7            OSD Output Clock Select  
                  0: from Internal Display Dot Clock  
                  1: from Internal Display Dot Clock x 2

D6            OSD Output VS Invert  
                  0: Normal  
                  1: Invert

D5-4          Reserved

D3            OSD Function  
                  0: OFF  
                  1: ON

D2            OSD Intensity Enable (For MOTOROLA)

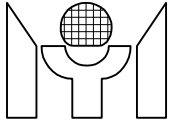

0: Disable  
1: Enable

D1-0      OSD TYPE Select  
00: OSDRGB = {R0000000, G0000000, B0000000}  
01: OSDRGB = {RR000000, GG000000, BB000000}  
10: OSDRGB = {RRRR0000, GGGG0000, BBBB0000}  
11: OSDRGB = {RRRRRRRR, GGGGGGGG, BBBBBBBB}  
R = OSDR, G = OSDG, B = OSDB

### OSD Control Register 1 (Address A1h) (R/W)

D7          OSD Output HS Invert  
0: Normal  
1: Invert.

D6          OSD Output DCLK Invert  
0: Normal  
1: Invert.

D5-4        OSD Output HS Delay  
4 steps to change, each of them is 1ns delay/step.

D3          OSD Input Data Sample Clock Invert  
0: Normal.  
1: Invert.

D2-0        OSD Input Data Sample Clock Delay  
8 steps to change, each of them is 1ns delay/step.

### OSD Control Register 2 (Address A2h) (R/W)

D7-4        Reserved

D3-0        OSD Output Clock Delay  
16 steps to change, each of them is 1ns delay/step.

### Output Invert Control (Address A4h) (R/W)

D7          Reserved

D6          RGB Data Invert Enable  
0: Disable  
1: Enable

D5          Display DCLK2 Invert  
0: Normal  
1: Invert

D4          Display DCLK1 Invert  
0: Normal  
1: Invert

D3          Reserved

D2          Display Data Enable (DDEN) Invert  
0: Normal

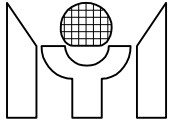

1: Invert

D1 Display VSYNC Invert  
0: Normal  
1: Invert

D0 Display HSYNC Invert  
0: Normal  
1: Invert

**Output Tri\_state Control (Address A5h) (R/W)**

D7 Display Data R2OUT, G2OUT, B2OUT Output Disable  
0: Normal  
1: Tri\_stated

D6 Display Data R1OUT, G1OUT, B1OUT Output Disable  
0: Normal  
1: Tri\_stated

D5 Display DCLK2 Output Disable  
0: Normal  
1: Tri\_stated

D4 Display DCLK1 Output Disable  
0: Normal  
1: Tri\_stated

D3 OSD OCLK / OVSYNC / OHSYNC Output Disable  
0: Normal  
1: Tri\_stated

D2 Display Data Enable (DDEN) Output Disable  
0: Normal  
1: Tri\_stated

D1 Display VSYNC Output Disable  
0: Normal  
1: Tri\_stated

D0 Display HSYNC Output Disable  
0: Normal  
1: Tri\_stated

**Output Clocks Delay Adjustment (Address A6h) (R/W)**

D7-4 Display DCLK2 delay adjustment  
16 steps to adjust, Typical 1ns delay/step

D3-0 Display DCLK1 delay adjustment  
16 steps to adjust, Typical 1ns delay/step

**Output Clocks Duty Cycle Adjustment (Address A7h) (R/W)**

D7 Display DCLK2 duty cycle Increase/Decrease  
0: Decrease  
1: Increase

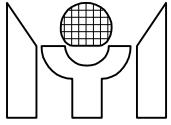

- D6-4 Display DCLK2 duty cycle adjustment  
8 steps to adjust, Typical 0.5ns delay/step
- D3 Display DCLK1 duty cycle Increase/Decrease  
0: Decrease  
1: Increase
- D2-0 Display DCLK1 duty cycle adjustment  
8 steps to adjust, Typical 0.5ns delay/step

**Output Miscellaneous Control (Address A9h) (R/W)**

- D7 Second field Line Buffer Overflow status for Interlace input **(RO)**  
0: Not Overflow  
1: Overflow
- D6 Second field Line Buffer Underflow status for Interlace input **(RO)**  
0: Not Underflow  
1: Underflow
- D5 First field Line Buffer Overflow status for Interlace input or  
Line buffer Overflow status for Non-interlace input **(RO)**  
0: Not Overflow  
1: Overflow
- D4 First field Line Buffer Underflow status for Interlace input or  
Line Buffer Overflow status for Non-interlace input **(RO)**  
0: Not Underflow  
1: Underflow
- D3 Auto Output Horizontal Total Calculation Start **(W)**  
0: Disable  
1: Enable  
Auto Output Horizontal Total Calculation Ready Flag **(R)**  
0: Ready  
1: Not Ready
- D2-0 Reserved

**Output Vertical Active Line Number - Low (Address AAh) (R/W)**

It defines the low byte of Output Vertical Active Line Number only used for getting the values of Reg. ACh and ADh.

- D7-0 OVDE[7:0]

**Output Vertical Active Line Number - High (Address ABh) (R/W)**

It defines the high byte of Output Vertical Active Line Number only used for getting the values of Reg. ACh and ADh.

- D1-0 OVDE[9:8]

**Output Horizontal Total Pixel Number - Low (Address ACh) (RO)**

It states the low byte of Output Horizontal Total Pixel Number.

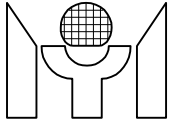

D7-0 OHTOT[7:0]

**Output Horizontal Total Pixel Number - High (Address ADh) (RO)**

It states the high byte of Output Horizontal Total Pixel Number.

D2-0 OHTOT[10:8]

**Output Horizontal Total Residue Number - Low (Address AEh) (RO)**

It states the low byte of Output Horizontal Total Pixel Residue Number.

D7-0 OHTOT\_RES[7:0]

**Output Horizontal Total Residue Number - High (Address AFh) (RO)**

It states the high byte of Output Horizontal Total Pixel Residue Number.

D7-2 Reserved

D1-0 OHTOT\_RES[9:8]

**Zoom Control Register 0 (Address B0h) (R/W)**

D7 Vertical Scale Mode  
0: Scale Up  
1: Scale Down

D6-4 Vertical Scale Select  
0XX: PASS mode  
10X: DUPLICATE mode  
110: BILINEAR mode  
111: INTERPOLATION TABLE mode (only for Scale Up)

D3 Horizontal Scale Mode  
0: scale up  
1: scale down

D2-0 Horizontal Scale Select  
0xx: PASS mode  
10x: DUPLICATE mode  
110: BILINEAR mode  
111: INTERPOLATION TABLE mode

**Zoom Control Register 1 (Address B1h) (R/W)**

D7-1 Reserved

D0 Interpolation Table R/W Access Enable  
0: Disable  
1: Enable

**Zoom Vertical Scale Down Integer Ratio Region (Address B2h) (R/W)**

It defines vertical scale down integer ratio value region



---

---

D7-3	Reserved
D2-0	ZVDIV[2:0] 0 : scale down ratio = 1-1/2(exclude 1) 1 : scale down ratio = 1/2-1/4(exclude 1/2) 2: scale down ratio = 1/4-1/8(exclude 1/4) 3: scale down ratio = 1/8-1/16(exclude 1/8) 4: scale down ratio = 1/16-1/32(exclude 1/16)

**Zoom Horizontal Scale Down Integer Ratio Region (Address B3h) (R/W)**

It defines horizontal scale down integer ratio value region.

D7-3	Reserved
D2-0	ZHDIV[2:0] 0 : scale down ratio = 1-1/2(exclude 1) 1 : scale down ratio = 1/2-1/4(exclude 1/2) 2: scale down ratio = 1/4-1/8(exclude 1/4) 3: scale down ratio = 1/8-1/16(exclude 1/8) 4: scale down ratio = 1/16-1/32(exclude 1/16)

**Zoom Vertical Scale Ratio – Low (Address B4h) (R/W)**

It defines the low byte of vertical scale ratio value for scale up and down.

D7-0	ZVSF[7:0]
------	-----------

**Zoom Vertical Scale Ratio - High (Address B5h) (R/W)**

It defines the low byte of vertical scale ratio value for scale up and down.

D7-0	ZVSF[15:8]
------	------------

For Scale Up  $ZVSF = \text{CEIL}[(\text{input\_height} - 1) / (\text{output\_height} - 1) * 2^{16}]$   
For Scale Down  $ZVSF = \text{CEIL}\{[(\text{input\_height}' - 1) / (\text{output\_height} - 1) - 1] * 2^{16}\}$   
,where  $\text{input\_height}' = \text{input\_height} / 2^{\text{ZVDIV}}$ . The means of ZVDIV is referenced to Reg. B2h.

**Zoom Horizontal Scale Ratio - Low (Address B6h) (R/W)**

It defines the low byte of horizontal scale ratio value for scale up and down.

D7-0	ZHSF[7:0]
------	-----------

**Zoom Horizontal Scale Ratio - High (Address B7h) (R/W)**

It defines the high byte of horizontal scale ratio value for scale up and down.

D7-0	ZHSF[15:8]
------	------------

For Scale Up  $ZHSF = \text{ROUND}[(\text{input\_width} - 1) / (\text{output\_width} - 1) * 2^{16}]$   
For Scale Down  $ZVSF = \text{ROUND}\{[(\text{input\_width}' - 1) / (\text{output\_width} - 1) - 1] * 2^{16}\}$   
,where  $\text{input\_width}' = \text{input\_width} / 2^{\text{ZHDIV}}$ . The means of ZHDIV is referenced to Reg. B3h.

**Interpolation Table Data Port (Address BFh) (R/W)**

It defines the entry address of the Interpolation table data port.



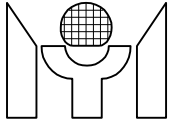

D7-0 TFPORT[7:0]

**Host Control Register 0 (Address C0h) (R/W)**

D7 Host Screen Write Stop Enable **(WO)**  
0: Disable  
1: Enable

D6-1 Force to 001010

D0 Host Screen Write Start Enable **(W)**  
0: Disable  
1: Enable  
Host Screen Write Ready Flag **(R)**  
0: Ready  
1: Not Ready

**Host Control Register 1 (Address C1h) (R/W)**

D7 Reserved

D6 I2C Bus Address No Increment  
0: Normal  
1: No Increment

D5 Double Buffer load Select  
0: Immediately  
1: Delay to Display VSYNC

D4 Registers Double Buffer function Enable  
0: Disable  
1: Enable

D3-2 Reserved

D1 Display Registers Double Buffer Load **(WO)**

D0 Input Registers Double Buffer Load **(WO)**

**Host Screen Write Line Length - Low (Address C4h) (R/W)**

It defines the low byte of the vertical line length for Host Screen Write.

D7-0 HS\_LEN[7:0]

**Host Screen Write Line Length - High (Address C5h) (R/W)**

It defines the high byte of the vertical line length for Host Screen Write.

D7-3 Reserved

D2-0 HS\_LEN[10:8]

**Host Fill RED Color (Address C6h) (R/W)**

It defines Fill Red color for Host Screen Write.

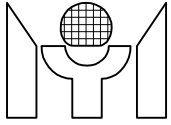

D7-0 HFR[7:0]

**Host Fill GREEN Color (Address C7h) (R/W)**

It defines Fill Green color for Host Screen Write.

D7-0 HFG[7:0]

**Host Fill BLUE Color (Address C8h) (R/W)**

It defines Fill Blue color for Host Screen Write.

D7-0 HFB[7:0]

**Host Access Mode Status (Address CBh) (RO)**

D7-1 Reserved

D0 Host Access Mode  
0: 2-wire Serial mode (IIC)  
1: 8-bit Parallel mode

**Memory Type Control (Address D0h) (R/W)**

It defines the Memory type and size.

D7-5 Reserved

D4 32 bits Memory Bus (Only for X2 Memory Configuration)  
0: Disable  
1: Enable

D3 Reserved

D2-0 000: 16M SDRAM X 3  
001: 16M SDRAM X 2  
010: 8M SGRAM X 3  
011: 8M SGRAM X 2  
10x: Reserved  
110: 16M SGRAM X 3  
111: 16M SGRAM X 2

**Memory Self Test Control (Address D2h) (R/W)**

It controls the operation of Memory Self Test Mode.

D7-3 Reserved

D2 Memory Self Test mode Result Status (RO)  
0: Success  
1: Fail

D1 Memory Self Test mode Finish Status (RO)  
0: Finish  
1: Not Finish

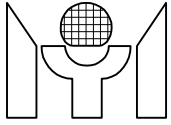

D0 Memory Self Test mode Enable  
0: Disable  
1: Enable

**Memory Line Offset – Low (Address D4h) (R/W)**

It defines the low byte of Memory Line Offset Address Length for Memory Read/Write.

D7-0 Line\_offset[7:0]

**Memory Line Offset – High (Address D5h) (R/W)**

It defines the high byte of Memory Line Offset Address Length for Memory Read/Write.

D7-3 Reserved

D2-0 Line\_offset[10:8]

**Memory Self-Test Compare Error Address – Low (Address DBh) (RO)**

It defines the low byte of Memory Base Address for Memory Self-Test comparing error report.

D7-0 MSFTBA [7:0]

**Memory Self-Test Compare Error Address – Middle (Address DCh) (RO)**

It defines the middle byte of Memory Base Address for Memory Self-Test comparing error report.

D7-0 MSFTBA [15:8]

**Memory Self-Test Compare Error Address – High (Address DDh) (RO)**

It defines the high byte of Memory Base Address for Memory Self-Test comparing error report and Patterns Number.

D7 Reserved

D6-5 Memory Self-Test Patterns Number when Comparing Error  
00: Pattern Constructed by Linear Memory Address  
01: 48 Bits Pattern Toggled between 55 and AA  
10: 48 Bits Pattern Toggled between AA and 55  
11: Reserved

D4-0 MSFTBA [20:16]

**Clock Synthesizer Control Register (Address E0h) (R/W)**

D7-4 Reserved

D3 Memory Clock Source  
0: Internal Memory Clock  
1: External Memory Clock from pin EXTMCLK

D2 Display Clock Source  
0: Internal Display Clock  
1: External Display Clock from pin EXTDCLK

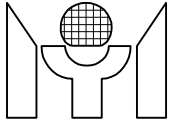

D1 Memory Clock Synthesizer Enable  
0: Enable  
1: Disable

D0 Display Clock Synthesizer Enable  
0: Enable  
1: Disable

### **Clock Synthesizer Value Load (Address E1h) (WO)**

D7-2 Reserved

D1 Memory Clock Synthesizer Value Load (WO)

D0 Display Clock Synthesizer Value Load (WO)

### **Display Clock Synthesizer N Value (Address E2h) (R/W)**

D7-0 Display Clock Synthesizer N value

### **Display Clock Synthesizer M Value (Address E3h) (R/W)**

D7-0 Display Clock Synthesizer M value

### **Memory Clock Synthesizer N Value (Address E4h) (R/W)**

D7-0 Memory Clock Synthesizer N value

### **Memory Clock Synthesizer M Value (Address E5h) (R/W)**

D7-0 Memory Clock Synthesizer M value

### **Clock Synthesizer R Value (Address E6h) (R/W)**

D7-4 Reserved

D3-2 Memory Clock Synthesizer R value  
00: No divided  
01: Divided by 2  
1x: Divided by 4

D1-0 Display Clock Synthesizer R value  
00: No divided  
01: Divided by 2  
1x: Divided by 4

### **SYNC Interrupt Flag Control (Address E8h) (R)**

It contains the status of SYNC Interrupts.

D7 Display VSYNC Pulse Interrupt Status  
0: No Display VSYNC pulse detected  
1: Any Display VSYNC pulse detected

D6 Input VSYNC Pulse Interrupt Status  
0: No Input VSYNC pulse detected  
1: Any Input VSYNC pulse detected

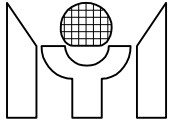

---

---

D5	VSYNC Presence Change Status 0: No Change 1: Change
D4	HSYNC Presence Change Status 0: No Change 1: Change
D3	VSYNC Polarity Change Status 0: No Change 1: Change
D2	HSYNC Polarity Change Status 0: No Change 1: Change
D1	VSYNC Frequency Change Status 0: No Change 1: Change
D0	HSYNC Frequency Change Status 0: No Change 1: Change

### **SYNC Interrupt Flag Control (Address E8h) (W)**

It is used to clear the corresponding SYNC interrupt signal when Software finishes serving the interrupt service routine.

D7	Clear Display VSYNC Pulse Interrupt Enable 0: Disable 1: Enable
D6	Clear Input VSYNC Pulse Interrupt Enable 0: Disable 1: Enable
D5	Clear VSYNC Presence Change Interrupt Enable 0: Disable 1: Enable
D4	Clear HSYNC Presence Change Interrupt Enable 0: Disable 1: Enable
D3	Clear VSYNC Polarity Change Interrupt Enable 0: Disable 1: Enable
D2	Clear HSYNC Polarity Change Interrupt Enable 0: Disable 1: Enable
D1	Clear VSYNC Frequency Change Interrupt Enable 0: Disable 1: Enable

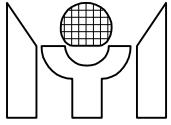

D0 Clear HSYNC Frequency Change Interrupt Enable  
0: Disable  
1: Enable

**General Interrupt Flag Control (Address E9h) (R)**

It contains the status of General Interrupts.

D7-2 Reserved

D1 Auto Position Finish Status (valid for Single mode only)  
0: Not Finish  
1: Finish

D0 Auto Calibration Finish Status (valid for Single mode only)  
0: Not Finish  
1: Finish

**General Interrupt Flag Control (Address E9h) (W)**

It is used to clear the corresponding general interrupt signal when Software finishes serving the interrupt service routine.

D7-2 Reserved

D1 Clear Auto Position Finish Interrupt Enable  
0: Disable  
1: Enable

D0 Clear Auto Calibration Finish Interrupt Enable  
0: Disable  
1: Enable

**SYNC Interrupt Flag Enable (Address EAh) (R/W)**

It is used to enable SYNC Interrupt function.

D7 Display VSYNC Pulse Interrupt Enable  
0: Disable  
1: Enable

D6 Input VSYNC Pulse Interrupt Enable  
0: Disable  
1: Enable

D5 VSYNC Presence Change Interrupt Enable  
0: Disable  
1: Enable

D4 HSYNC Presence Change Interrupt Enable  
0: Disable  
1: Enable

D3 VSYNC Polarity Change Interrupt Enable  
0: Disable  
1: Enable

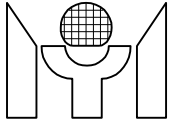

- 
- |    |  |
|----|--|
| D2 | HSYNC Polarity Change Interrupt Enable<br>0: Disable<br>1: Enable  |
| D1 | VSYNC Frequency Change Interrupt Enable<br>0: Disable<br>1: Enable |
| D0 | HSYNC Frequency Change Interrupt Enable<br>0: Disable<br>1: Enable |

### **General Interrupt Flag Enable (Address EBh) (R/W)**

It is used to enable General Interrupt functions.

- |      |   |
|------|---|
| D7   | Interrupt Output Polarity Invert<br>0: Active Low<br>1: Active High |
| D6-2 | Reserved  |
| D1   | Auto Position Finish Interrupt Enable<br>0: Disable<br>1: Enable    |
| D0   | Auto Calibration Finish Interrupt Enable<br>0: Disable<br>1: Enable |

### **HS Frequency Change Interrupt Compare (Address ECh) (R/W)**

It is used to control Interrupt generation by comparing the frequency change value when Input HS Frequency Changes.

- |      |               |
|------|---------------|
| D7-0 | HSCMPREG[7:0] |
|------|---------------|

### **Power Management Control (Address F1h) (R/W)**

- |      |  |
|------|--|
| D7   | Reserved   |
| D6   | Power Down Gamma & Interpolation Table<br>0: Normal<br>1: Power Down |
| D5   | Power Down Output Line Buffers<br>0: Normal<br>1: Power Down         |
| D4   | Power Down Input Line Buffers<br>0: Normal<br>1: Power Down          |
| D3-2 | Reserved   |
| D1   | Power Down all the clocks except REFCLK<br>0: Normal                 |



1: Power Down

D0 Software Reset Enable  
0: Disable  
1: Enable

**GPIO Control Register (Address F4h) (R/W)**

It controls the data of the GPIO pins.

D7-0 GPIO[7:0]

**GPIO Direction Control (Address F5h) (R/W)**

It controls the In/Out direction of the GPIO pins, where “0” means Output, and “1” means Tri\_state or Input.

D7-6 GPIO[7:6] Output Enable  
0: Output  
1: Tri\_state

D5-0 GPIO[5:0] In/Out Select  
0: Output  
1: Input

**GPIO Misc Control (Address F6h) (R/W)**

It defines the GPIO pins miscellaneous control.

D7-1 Reserved

D0 GPIO[7:6] Output Pins Source  
0: from Reg. F4h/D7-6  
1: from ADVS/ADHS



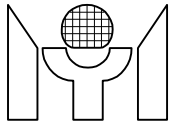

## 5. ELECTRICAL CHARACTERISTICS

### 5.1 DC CHARACTERISTICS

Table 5.1 Recommended Operating Conditions

SYMBOL	PARAMETER	MIN	TYP	MAX	UNIT
Vcc	Operation Voltage	3.0	3.3	3.6	V
Tamb	Operating Ambient Temperature	0		70	°C
Tstg	Storage Temperature	-55		150	°C

Table 5.2 DC Electrical Characteristics for 3.3 V Operation

SYMBOL	PARAMETER	CONDITIONS	MIN	TYP	MAX	UNIT
VIL	Input Low Voltage				0.8	V
VIH	Input High Voltage		2.0			V
Vt-	Input Schmitt Trigger Low Voltage at pins SDA and SCK			1.0		
Vt+	Input Schmitt Trigger High Voltage at pins SDA and SCK			1.7		
VOL	Output Low Voltage				0.4	V
VOH	Output High Voltage		2.4			V
RI	Input Pull-up/Down Resistance	VIL = 0v or VIH = VCC		75		Kohm
ILI	Input Leakage Current		-10		10	uA
ILO	Output Leakage Current		-20		20	uA

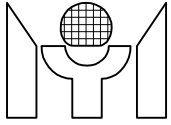

## 5.2 AC CHARACTERISTICS

### À Input Interface Timing

Figure 5.2.1 Input Interface Timing

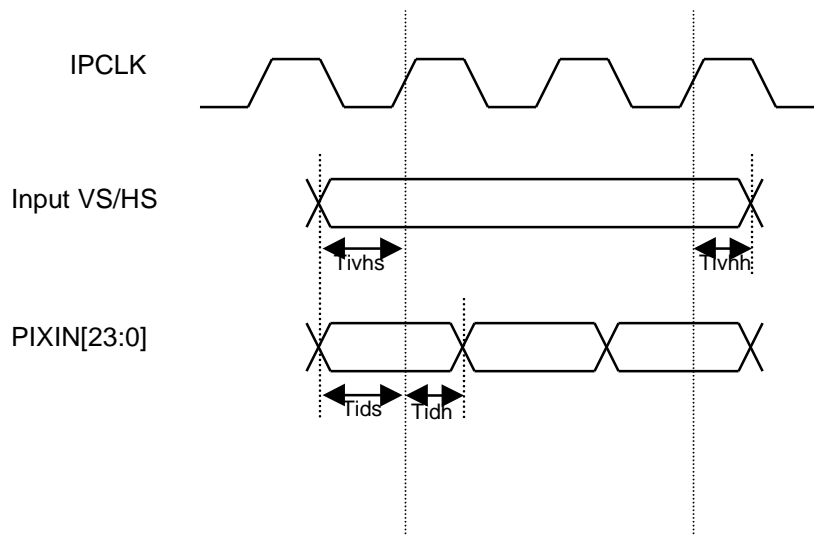
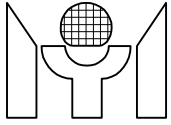

Table 5.2.1 Input Interface Timing

SYMBOL	PARAMETER	MIN	MAX	UNIT
$T_{ids}$	Input Image Signal Setup Time for IPCLK	2		ns
$T_{idh}$	Input Image Signal Hold Time for IPCLK	3		ns
$T_{ivhs}$	Input VSYNC/HSYNC Setup Time for IPCLK	2		ns
$T_{ivhh}$	Input VSYNC/HSYNC Hold Time for IPCLK	3		ns



Ā **Output Interface Timing**

**Figure 5.2.2 Output Interface Timing**

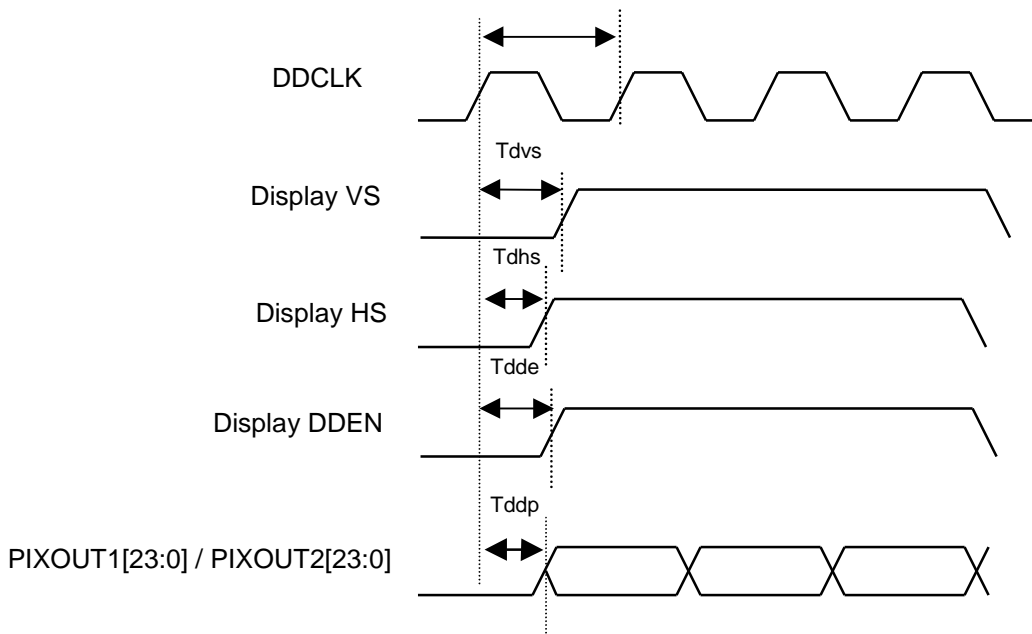

**Table 5.2.2 Output Interface Timing**

SYMBOL	PARAMETER	MIN	MAX	UNIT
Tdck	Display Clock DDCLK Frequency	10		ns
Tdvs	Display VSYNC Output Delay to DDCLK	2		ns
Tdhs	Display HSYNC Output Delay to DDCLK	0.5		ns
Tdde	Display DDEN Output Delay to DDCLK	1		ns
Tddp	Display Data Output Delay to DDCLK	1.5		ns

Note: DDCLK phase can be adjusted relative to data and control outputs using the DDCLK\_INV (Reg. A4h/D5-4) and DDCLK\_DELAY[2:0] (Reg. A6h/D7-0) programming controls.

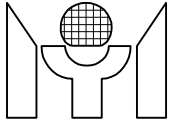

Ā **OSD Interface Timing**

**Figure 5.2.3 OSD Interface Timing**

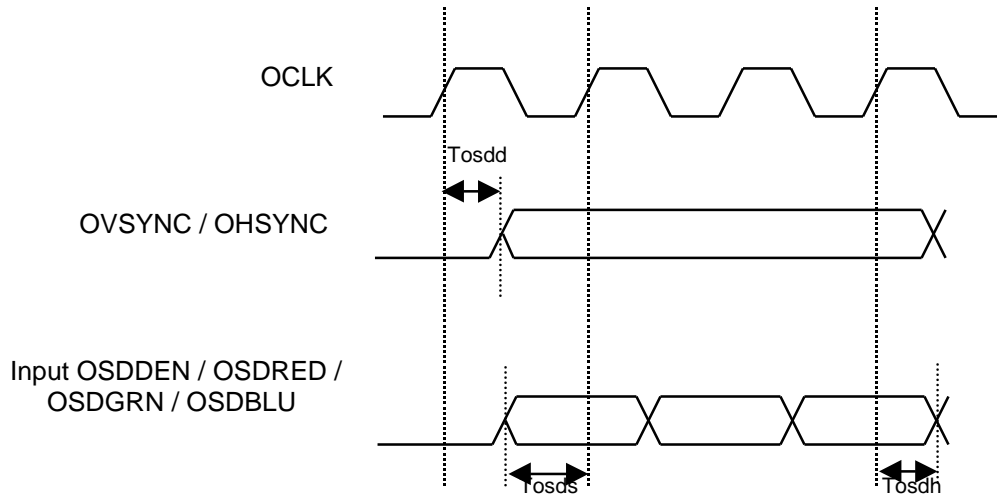

**Table 5.2.3 OSD Interface Timing**

SYMBOL	PARAMETER	MIN	MAX	UNIT
Tosdd	OSD VS / HS Output Delay to OCLK	2		ns
Tosds	OSD Signal Input Setup Time for OCLK	5.5		ns
Tosdh	OSD Signal Input Hold Time for OCLK	0		ns

Note: OCLK phase can be adjusted using OCLK\_INV (Reg. A1h/D3) programming control and OHSYNC phase can be adjusted using OHSYNC\_DELAY[1:0] (Reg. A1h/D5-4) programming control.

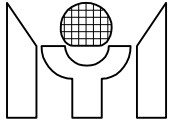

Ā I2C Host Interface Timing

Figure 5.2.4 I2C Host Interface Timing

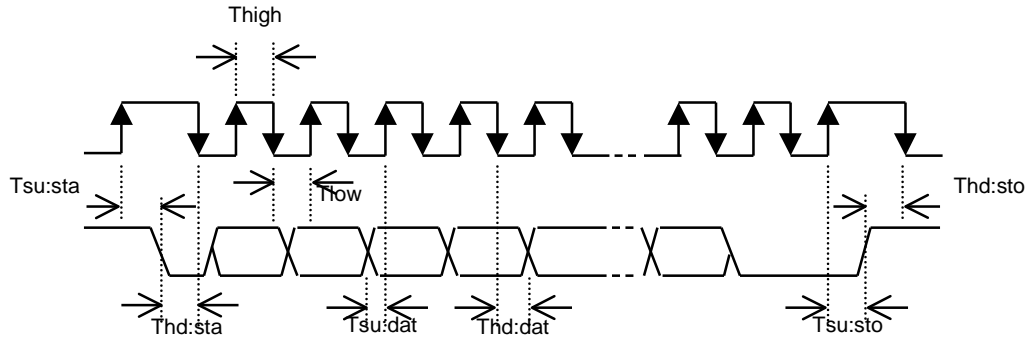
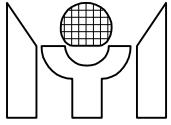

Table 5.2.4 I2C Host Interface Timing

SYMBOL	PARAMETER	MIN	MAX	UNIT
$T_{high}$	Clock High Period	500		ns
$T_{low}$	Clock Low Period	500		ns
$T_{su:dat}$	Data in Setup Time	200		ns
$T_{hd:dat}$	Data in Hold Time	100		ns
$T_{su:sta}$	Start condition Setup Time	500		ns
$T_{hd:sta}$	Start condition Hold Time	500		ns
$T_{su:sto}$	Stop condition Setup Time	500		ns
$T_{hd:sto}$	Stop condition Hold Time	500		ns



Ā **8-bit Direct Host Interface Timing**

**Figure 5.2.5 8-bit Direct Host Interface Timing**

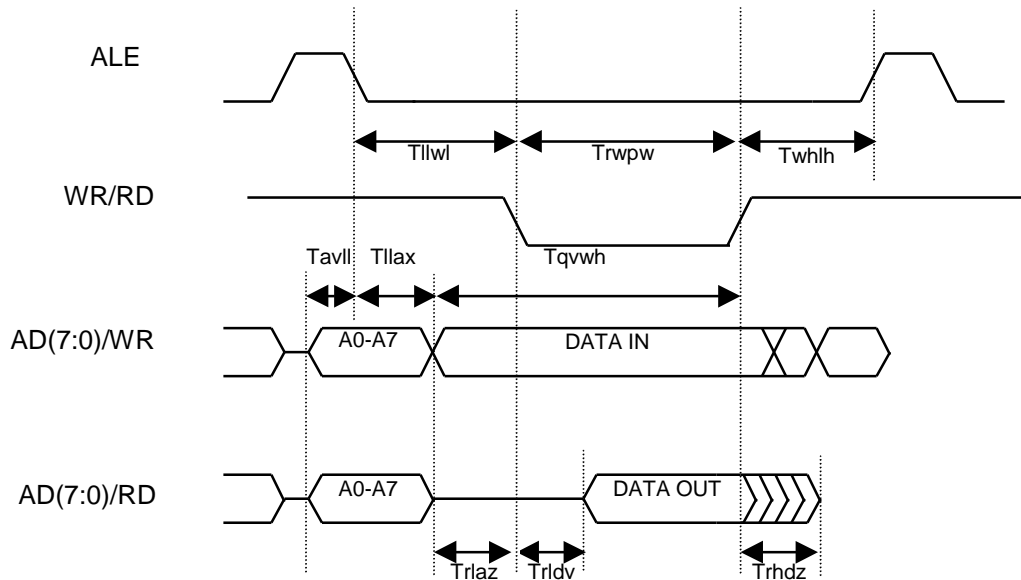

**Table 5.2.5 8-bit Direct Host Interface Timing**

SYMBOL	PARAMETER	MIN	MAX	UNIT
Tavll	Address Valid to ALE Low	3		ns
Tllax	Address Hold After ALE Low	5		ns
Trwpw	WR/RD Pulse Width	35		ns
Tllwl	ALE Low to WR/RD Low	5		ns
Tqvwh	Data Valid to WR High	3		ns
Twhqx	Data Hold After WR	10		ns
Twhlh	WR/RD High to ALE High	0		ns
Trlaz	RD Low to Address Float	-5		ns
Trldv	RD Low to Valid Data In		30	ns
Trhdz	Data Float after RD High	0	15	ns

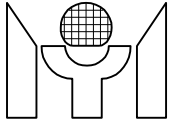

Ā **Memory Interface (SDRAM/SGRAM) Timing**

**Figure 5.2.6 Memory Interface Timing**

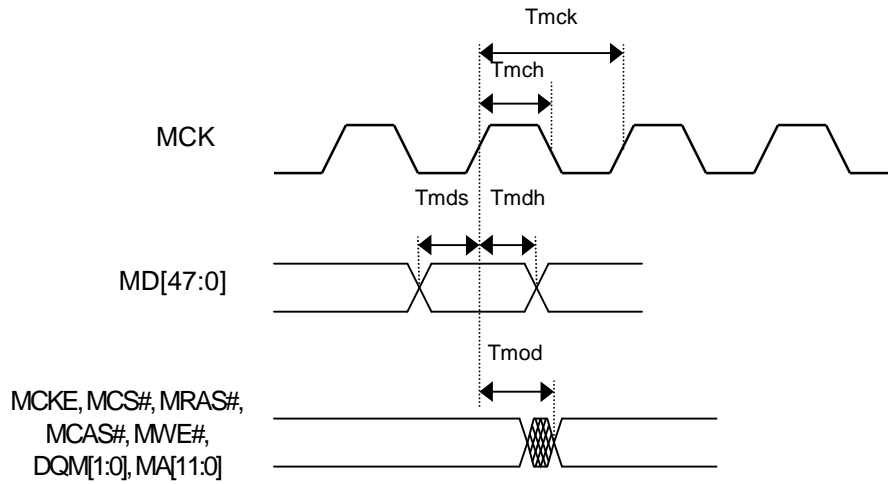

**Table 5.2.6 Memory Interface Timing**

SYMBOL	PARAMETER	MIN	MAX	UNIT
$T_{mck}$	Memory Clock Cycle Time	8.5		ns
$T_{mch}/T_{mck}$	Memory Clock Duty Cycle	0.4	0.6	ns
$T_{m ds}$	Data-in Setup Time for MCK	1		ns
$T_{m dh}$	Data-in Hold Time for MCK	2		ns
$T_{m od}$	Memory Output Delay to MCK	2	8.5	ns



**6. PACKAGE DIMENSION**

120/128/132/144/160/184/208/256L OFF

28 X 28 X 3.32 mm

2.6mm FOOTPRINT

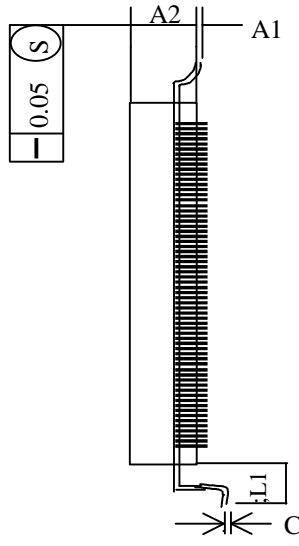
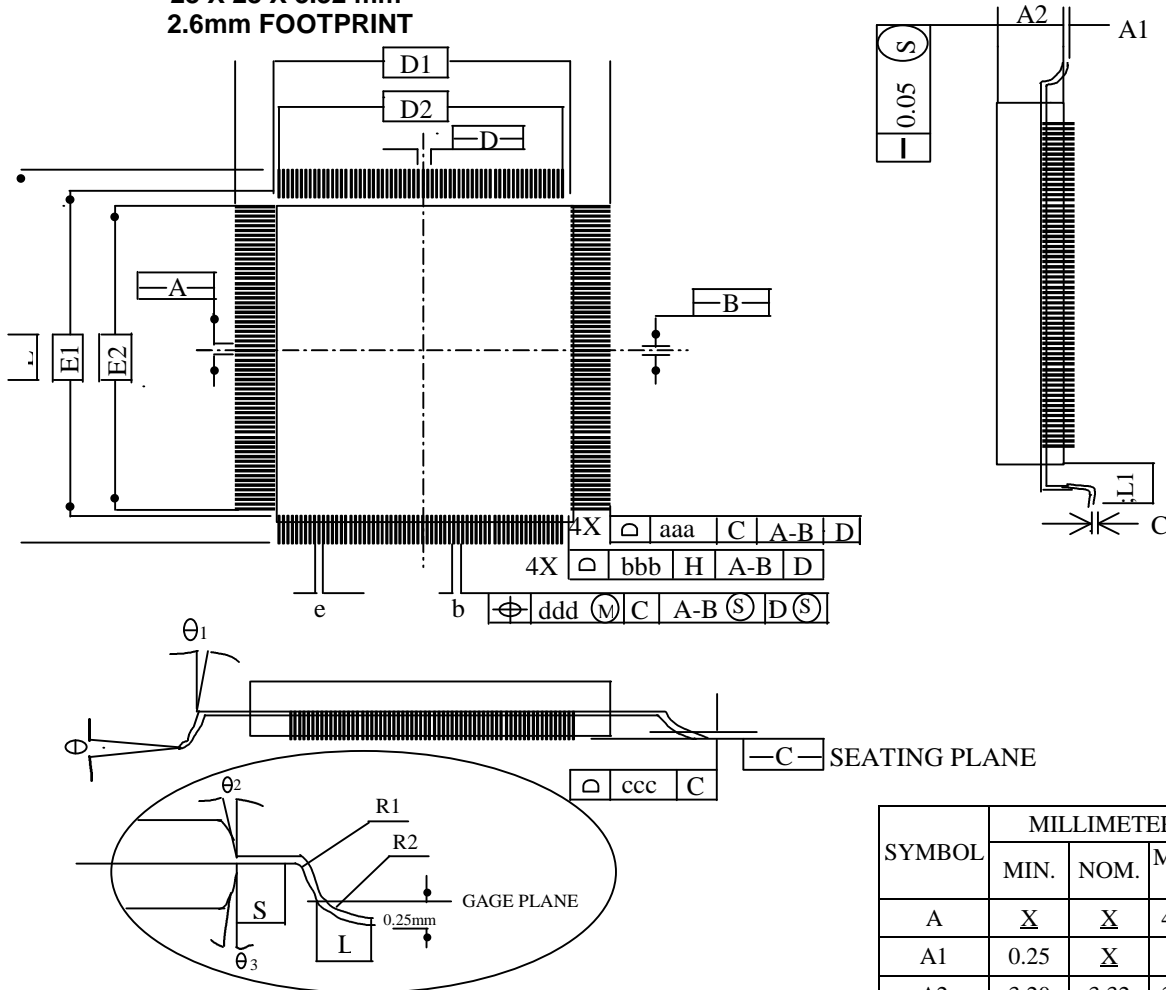

SYMBOL	MILLIMETER			INCH		
	MIN.	NOM.	MAX.	MIN.	NOM.	MAX.
A	X	X	4.10	X	X	0.161
A1	0.25	X	X	0.010	X	X
A2	3.20	3.32	3.60	0.126	0.131	0.142
D	30.60 BSC			1.205 BSC		
D1	28.00 BSC			1.102 BSC		
E	30.60 BSC			1.205 BSC		
E1	28.00 BSC			1.102 BSC		
R2	0.08	X	0.25	0.003	X	0.010
R1	0.08	X		0.003	X	X
$\theta$	0°	3.5°	7°	0°	3.5°	7°
$\theta_1$	0°	X	X	0°	X	X
$\theta_2$	8° REF			8° REF		
$\theta_3$	8° REF			8° REF		
C	0.09	0.15	0.20	0.004	0.005	0.008
L	0.45	0.60	0.75	0.018	0.024	0.030
L1	1.30			0.051 REF		
S	0.20	X	X	0.008	X	X

MIN.	NOM.	MAX.	MIN.	NOM.	MAX.
0.13	0.16	0.23	0.005	0.006	0.009
0.40 BSC.			0.016 BSC.		
25.20			0.992		
25.20			0.992		
TOLERANCES OF FORM AND POSITION					
0.20			0.008		
0.20			0.008		
X	0.08	X	X	0.003	X
X	0.07	X	X	0.003	X

- NOTES:**
- DIMENSIONS D1 AND E1 DO NOT INCLUDE MOLD PROTRUSION.
  - SIMENSION b DOES NOT INCLUDE DAMBAR PROTRUSION. ALLOWABLE DAMBAR PROTRUSION SHALL NOT CAUSE THE LEAD WIDTH TO EXCEED THE MAXIMUM b DIMENSION BY MORE THAN 0.08mm. DAMBAR CAN NOT BE LOCATED ON THE LOWER RADIUS OR THE FOOT. THE MINIMUM SPACE BETWEEN PROTRUSION AND AN ADJACENT LEAD SHALL NOT BE LESS THAN 0.07 mm.
  - THE TOP PACKAGE BODY SIZE MAY BE SMALLER THAN THE BOTTOM PACKAGE BODY SIZE.