

# MOTOROLA

## SEMICONDUCTOR

### TECHNICAL DATA

## Designer's Data Sheet

# Power Field Effect Transistor

## N-Channel Enhancement-Mode Silicon Gate

This TMOS Power FET is designed for high speed power switching applications such as switching regulators, converters, solenoid and relay drivers.

- Silicon Gate for Fast Switching Speeds — Switching Times Specified at 100°C
- Designer's Data —  $I_{DSS}$ ,  $V_{DS(on)}$ ,  $V_{GS(th)}$  and SOA Specified at Elevated Temperature
- Rugged — SOA is Power Dissipation Limited
- Source-to-Drain Diode Characterized for Use With Inductive Loads



# MTM40N20

TMOS POWER FET  
40 AMPERES  
 $R_{DS(on)} = 0.08 \text{ OHM}$   
200 VOLTS

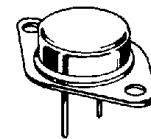
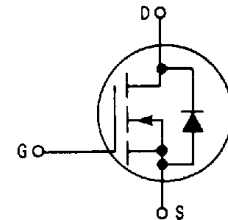

CASE 197A-03  
TO-204AE

### MAXIMUM RATINGS

Rating	Symbol	Value	Unit
Drain-Source Voltage	$V_{DSS}$	200	Vdc
Drain-Gate Voltage ( $R_{GS} = 1 \text{ M}\Omega$ )	$V_{DGR}$	200	Vdc
Gate-Source Voltage	$V_{GS}$	$\pm 20$	Vdc
Continuous	$V_{GSM}$	$\pm 40$	Vpk
Non-repetitive ( $t_p \leq 50 \mu\text{s}$ )			
Drain Current — Continuous	$I_D$	40	Adc
— Pulsed	$I_{DM}$	200	
Total Power Dissipation @ $T_C = 25^\circ\text{C}$	$P_D$	250	Watts
Derate above $25^\circ\text{C}$		2	W/°C
Operating and Storage Temperature Range	$T_J, T_{stg}$	-65 to 150	°C

### THERMAL CHARACTERISTICS

Thermal Resistance — Junction to Case	$R_{\theta JC}$	0.5	°C/W
— Junction to Ambient	$R_{\theta JA}$	30	
Maximum Lead Temperature for Soldering Purposes, 1/8" from case for 5 seconds	$T_L$	300	°C

### ELECTRICAL CHARACTERISTICS ( $T_C = 25^\circ\text{C}$ unless otherwise noted)

Characteristic	Symbol	Min	Max	Unit
----------------	--------	-----	-----	------

### OFF CHARACTERISTICS

Drain-Source Breakdown Voltage ( $V_{GS} = 0, I_D = 0.25 \text{ mA}$ )	$V_{(BR)DSS}$	200	—	Vdc
Zero Gate Voltage Drain Current ( $V_{DS} = \text{Rated } V_{DSS}, V_{GS} = 0$ )	$I_{DSS}$	—	10	$\mu\text{Adc}$
( $V_{DS} = \text{Rated } V_{DSS}, V_{GS} = 0, T_J = 125^\circ\text{C}$ )		—	100	
Gate-Body Leakage Current, Forward ( $V_{GSF} = 20 \text{ Vdc}, V_{DS} = 0$ )	$I_{GSSF}$	—	100	nAdc
Gate-Body Leakage Current, Reverse ( $V_{GSR} = 20 \text{ Vdc}, V_{DS} = 0$ )	$I_{GSSR}$	—	100	nAdc

(continued)

Designer's Data for "Worst Case" Conditions — The Designer's Data Sheet permits the design of most circuits entirely from the information presented. Limit curves — representing boundaries on device characteristics — are given to facilitate "worst case" design.

**ELECTRICAL CHARACTERISTICS — continued** ( $T_C = 25^\circ\text{C}$  unless otherwise noted)

Characteristic	Symbol	Min	Max	Unit
----------------	--------	-----	-----	------

**ON CHARACTERISTICS\***

Gate Threshold Voltage ( $V_{DS} = V_{GS}, I_D = 1 \text{ mA}$ ) $T_J = 100^\circ\text{C}$	$V_{GS(th)}$	2 1.5	4.5 4	Vdc
Static Drain-Source On-Resistance ( $V_{GS} = 10 \text{ Vdc}, I_D = 20 \text{ Adc}$ )	$R_{DS(on)}$	—	0.08	Ohm
Drain-Source On-Voltage ( $V_{GS} = 10 \text{ V}$ ) ( $I_D = 40 \text{ Adc}$ ) ( $I_D = 20 \text{ Adc}, T_J = 100^\circ\text{C}$ )	$V_{DS(on)}$	— —	3.8 3.2	Vdc
Forward Transconductance ( $V_{DS} = 15 \text{ V}, I_D = 20 \text{ A}$ )	$g_{FS}$	10	—	mhos

**DYNAMIC CHARACTERISTICS**

Input Capacitance	( $V_{DS} = 25 \text{ V}, V_{GS} = 0,$ $f = 1 \text{ MHz}$ )	$C_{iss}$	—	5500	pF
Output Capacitance		$C_{oss}$	—	1500	
Reverse Transfer Capacitance		$C_{rss}$	—	500	

**SWITCHING CHARACTERISTICS\* ( $T_J = 100^\circ\text{C}$ )**

Turn-On Delay Time	( $V_{DD} = 25 \text{ V}, I_D = 0.5 \text{ Rated } I_D$ $R_{gen} = 50 \text{ ohms}$ ) See Figures 13 and 14	$t_{d(on)}$	—	60	ns
Rise Time		$t_r$	—	300	
Turn-Off Delay Time		$t_{d(off)}$	—	400	
Fall Time		$t_f$	—	250	
Total Gate Charge	( $V_{DS} = 0.8 \text{ Rated } V_{DSS},$ $I_D = \text{Rated } I_D, V_{GS} = 10 \text{ V}$ ) See Figure 12	$Q_g$	85 (Typ)	95	nC
Gate-Source Charge		$Q_{gs}$	45 (Typ)	—	
Gate-Drain Charge		$Q_{gd}$	40 (Typ)	—	

**SOURCE DRAIN DIODE CHARACTERISTICS\***

Forward On-Voltage	( $I_S = \text{Rated } I_D,$ $V_{GS} = 0$ )	$V_{SD}$	2.0 (Typ)	2.5	Vdc
Forward Turn-On Time		$t_{on}$	Limited by stray inductance		
Reverse Recovery Time		$t_{rr}$	200 (Typ)	—	ns

**INTERNAL PACKAGE INDUCTANCE**

Internal Drain Inductance (Measured from the contact screw on the header closer to the source pin and the center of the die)	$L_d$	5 (Typ)	—	nH
Internal Source Inductance (Measured from the source pin, 0.25" from the package to the source bond pad)	$L_s$	12.5 (Typ)	—	

\*Pulse Test. Pulse Width  $\leq 300 \mu\text{s}$ , Duty Cycle  $\leq 2\%$

TYPICAL ELECTRICAL CHARACTERISTICS

3

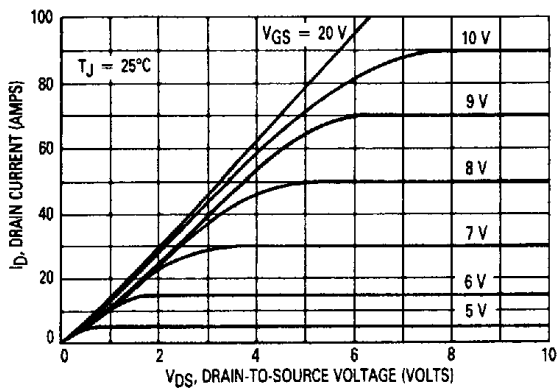

Figure 1. On-Region Characteristics

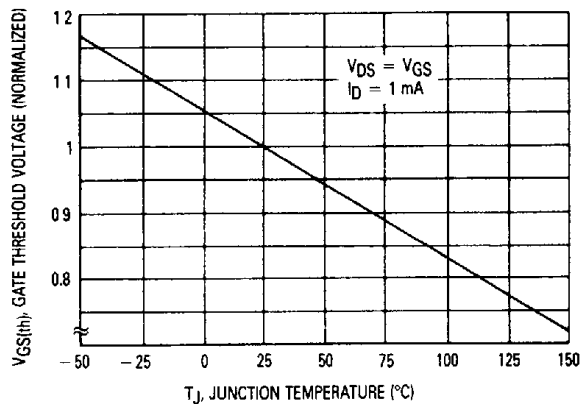

Figure 2. Gate-Threshold Voltage Variation With Temperature

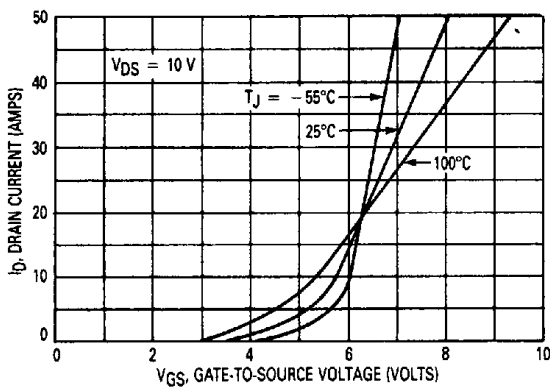

Figure 3. Transfer Characteristics

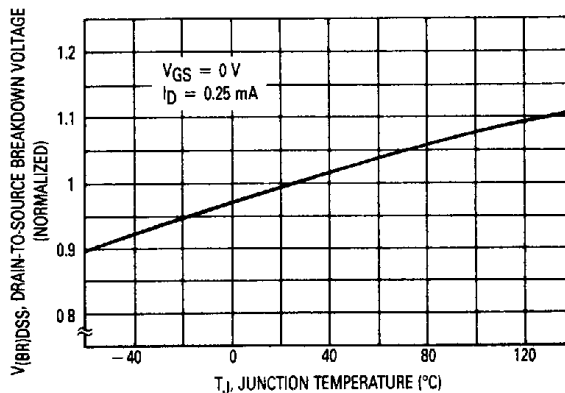

Figure 4. Breakdown Voltage Variation With Temperature

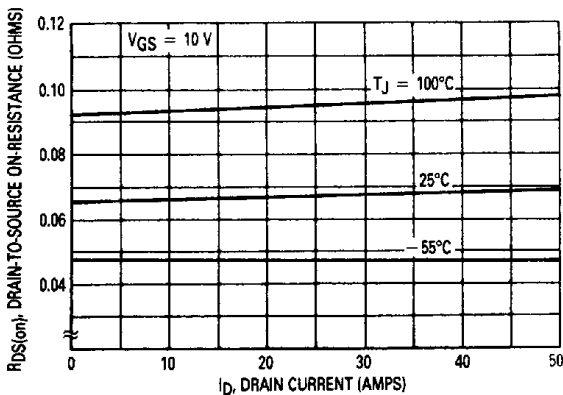

Figure 5. On-Resistance versus Drain Current

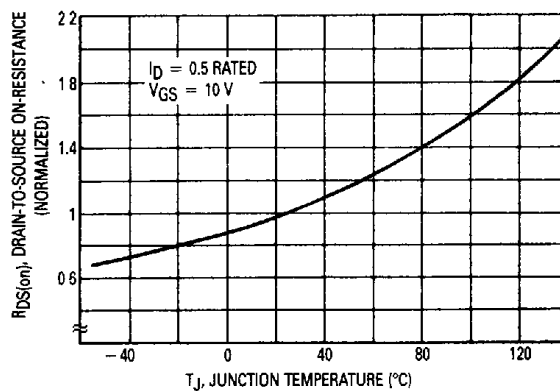

Figure 6. On-Resistance Variation With Temperature

SAFE OPERATING AREA INFORMATION

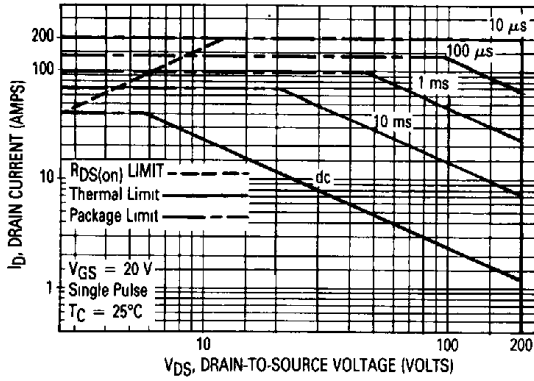

Figure 7. Maximum Rated Forward Biased Safe Operating Area

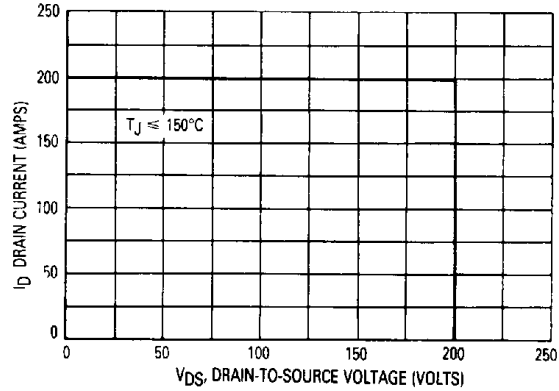

Figure 8. Maximum Rated Switching Safe Operating Area

FORWARD BIASED SAFE OPERATING AREA

The FBSOA curves define the maximum drain-to-source voltage and drain current that a device can safely handle when it is forward biased, or when it is on, or being turned on. Because these curves include the limitations of simultaneous high voltage and high current, up to the rating of the device, they are especially useful to designers of linear systems. The curves are based on a case temperature of 25°C and a maximum junction temperature of 150°C. Limitations for repetitive pulses at various case temperatures can be determined by using the thermal response curves. Motorola Application Note, AN569, "Transient Thermal Resistance-General Data and Its Use" provides detailed instructions.

SWITCHING SAFE OPERATING AREA

The switching safe operating area (SOA) of Figure 8 is the boundary that the load line may traverse without incurring damage to the MOSFET. The fundamental limits are the peak current,  $I_{DM}$  and the breakdown voltage,  $V_{(BR)DSS}$ . The switching SOA shown in Figure 8 is applicable for both turn-on and turn-off of the devices for switching times less than one microsecond.

The power averaged over a complete switching cycle must be less than:

$$\frac{T_{J(max)} - T_C}{R_{\theta JC}}$$

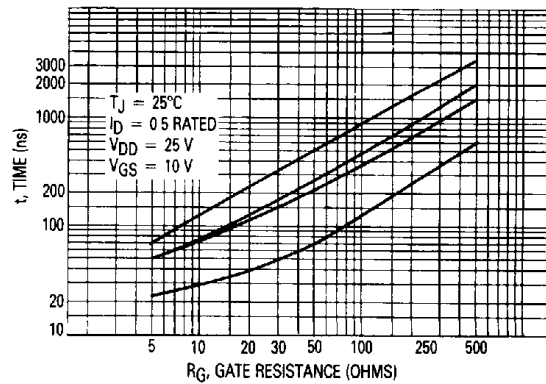

Figure 9. Resistive Switching Time Variation versus Gate Resistance

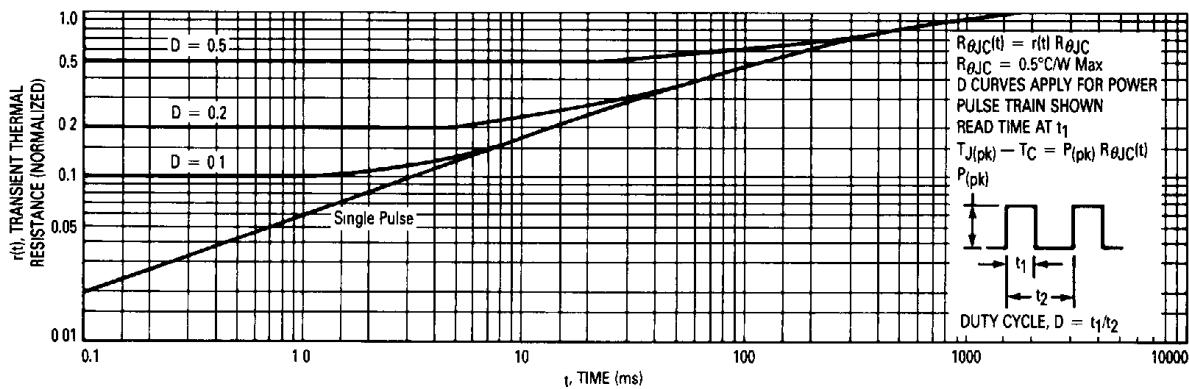

Figure 10. Thermal Response

3

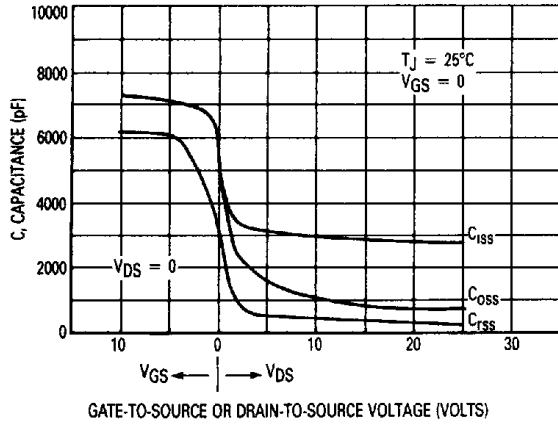

Figure 11. Capacitance Variation

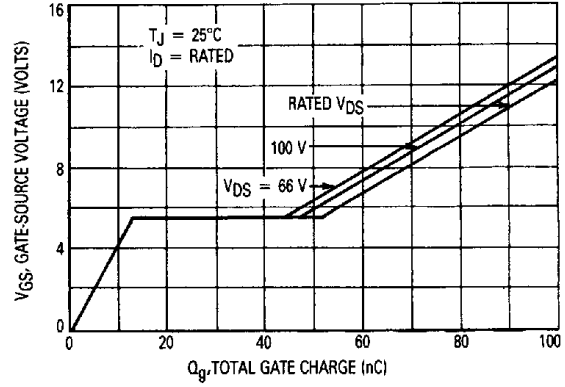

Figure 12. Gate Charge versus Gate-to-Source Voltage

RESISTIVE SWITCHING

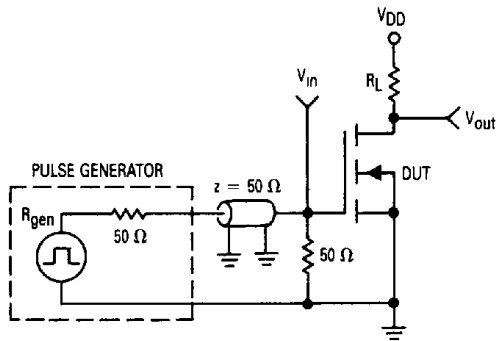

Figure 13. Switching Test Circuit

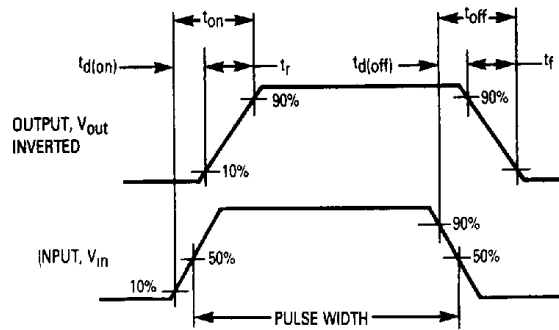

Figure 14. Switching Waveforms