

# MUN2211, MMUN2211L, MUN5211, DTC114EE, DTC114EM3, NSBC114EF3

## Digital Transistors (BRT) R1 = 10 kΩ, R2 = 10 kΩ

### NPN Transistors with Monolithic Bias Resistor Network

This series of digital transistors is designed to replace a single device and its external resistor bias network. The Bias Resistor Transistor (BRT) contains a single transistor with a monolithic bias network consisting of two resistors; a series base resistor and a base-emitter resistor. The BRT eliminates these individual components by integrating them into a single device. The use of a BRT can reduce both system cost and board space.

#### Features

- Simplifies Circuit Design
- Reduces Board Space
- Reduces Component Count
- S and NSV Prefix for Automotive and Other Applications Requiring Unique Site and Control Change Requirements; AEC-Q101 Qualified and PPAP Capable
- These Devices are Pb-Free, Halogen Free/BFR Free and are RoHS Compliant

#### MAXIMUM RATINGS (T<sub>A</sub> = 25°C)

Rating	Symbol	Max	Unit
Collector-Base Voltage	V <sub>CBO</sub>	50	Vdc
Collector-Emitter Voltage	V <sub>CEO</sub>	50	Vdc
Collector Current - Continuous	I <sub>C</sub>	100	mAdc
Input Forward Voltage	V <sub>IN(fwd)</sub>	40	Vdc
Input Reverse Voltage	V <sub>IN(rev)</sub>	10	Vdc

Stresses exceeding those listed in the Maximum Ratings table may damage the device. If any of these limits are exceeded, device functionality should not be assumed, damage may occur and reliability may be affected.



ON Semiconductor®

[www.onsemi.com](http://www.onsemi.com)

#### PIN CONNECTIONS

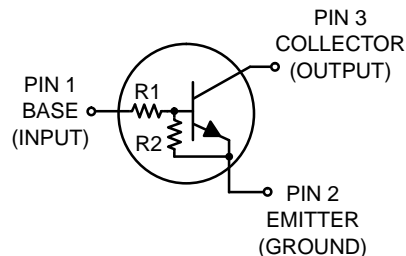

#### MARKING DIAGRAMS

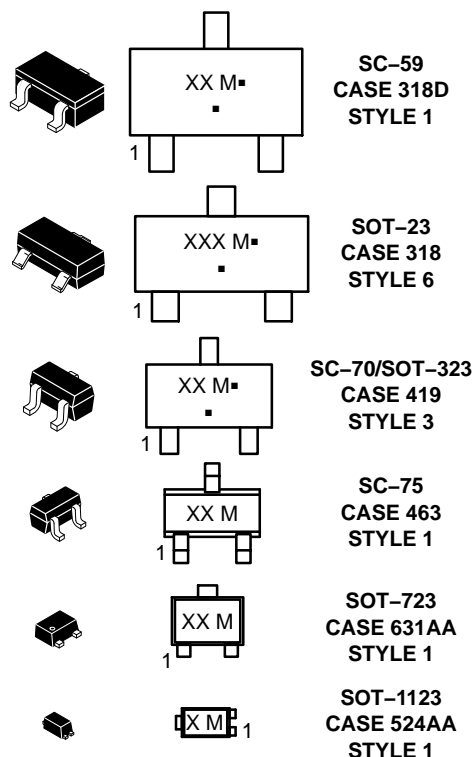

XXX = Specific Device Code  
M = Date Code\*  
▪ = Pb-Free Package

(Note: Microdot may be in either location)

\*Date Code orientation may vary depending upon manufacturing location.

#### ORDERING INFORMATION

See detailed ordering, marking, and shipping information in the package dimensions section on page 2 of this data sheet.

# MUN2211, MMUN2211L, MUN5211, DTC114EE, DTC114EM3, NSBC114EF3

**Table 1. ORDERING INFORMATION**

Device	Part Marking	Package	Shipping†
MUN2211T1G, SMUN2211T1G	8A	SC-59 (Pb-Free)	3000 / Tape & Reel
MUN2211T3G, SMUN2211T3G	8A	SC-59 (Pb-Free)	10000 / Tape & Reel
MMUN2211LT1G, SMMUN2211LT1G	A8A	SOT-23 (Pb-Free)	3000 / Tape & Reel
MMUN2211LT3G, SMMUN2211LT3G	A8A	SOT-23 (Pb-Free)	10000 / Tape & Reel
MUN5211T1G, SMUN5211T1G	8A	SC-70/SOT-323 (Pb-Free)	3000 / Tape & Reel
SMUN5211T3G	8A	SC-70/SOT-323 (Pb-Free)	10000 / Tape & Reel
DTC114EET1G, SDTC114EET1G	8A	SC-75 (Pb-Free)	3000 / Tape & Reel
DTC114EM3T5G	8A	SOT-723 (Pb-Free)	8000 / Tape & Reel
NSBC114EF3T5G	A	SOT-1123 (Pb-Free)	8000 / Tape & Reel

†For information on tape and reel specifications, including part orientation and tape sizes, please refer to our Tape and Reel Packaging Specifications Brochure, BRD8011/D.

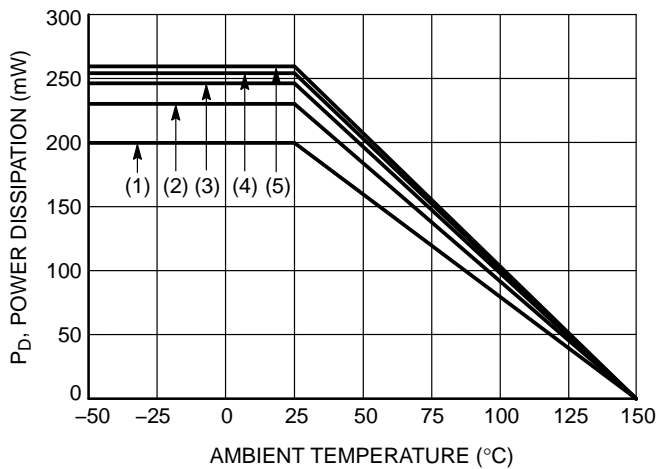

- (1) SC-75 and SC-70/SOT323; Minimum Pad
- (2) SC-59; Minimum Pad
- (3) SOT-23; Minimum Pad
- (4) SOT-1123; 100 mm<sup>2</sup>, 1 oz. copper trace
- (5) SOT-723; Minimum Pad

**Figure 1. Derating Curve**

MUN2211, MMUN2211L, MUN5211, DTC114EE, DTC114EM3, NSBC114EF3

Table 2. THERMAL CHARACTERISTICS

Characteristic	Symbol	Max	Unit
<b>THERMAL CHARACTERISTICS (SC-59) (MUN2211)</b>			
Total Device Dissipation T <sub>A</sub> = 25°C (Note 1) (Note 2) Derate above 25°C (Note 1) (Note 2)	P <sub>D</sub>	230 338 1.8 2.7	mW mW/°C
Thermal Resistance, Junction to Ambient (Note 1) (Note 2)	R <sub>θJA</sub>	540 370	°C/W
Thermal Resistance, Junction to Lead (Note 1) (Note 2)	R <sub>θJL</sub>	264 287	°C/W
Junction and Storage Temperature Range	T <sub>J</sub> , T <sub>stg</sub>	-55 to +150	°C

**THERMAL CHARACTERISTICS (SOT-23) (MMUN2211L)**

Total Device Dissipation T <sub>A</sub> = 25°C (Note 1) (Note 2) Derate above 25°C (Note 1) (Note 2)	P <sub>D</sub>	246 400 2.0 3.2	mW mW/°C
Thermal Resistance, Junction to Ambient (Note 1) (Note 2)	R <sub>θJA</sub>	508 311	°C/W
Thermal Resistance, Junction to Lead (Note 1) (Note 2)	R <sub>θJL</sub>	174 208	°C/W
Junction and Storage Temperature Range	T <sub>J</sub> , T <sub>stg</sub>	-55 to +150	°C

**THERMAL CHARACTERISTICS (SC-70/SOT-323) (MUN5211)**

Total Device Dissipation T <sub>A</sub> = 25°C (Note 1) (Note 2) Derate above 25°C (Note 1) (Note 2)	P <sub>D</sub>	202 310 1.6 2.5	mW mW/°C
Thermal Resistance, Junction to Ambient (Note 1) (Note 2)	R <sub>θJA</sub>	618 403	°C/W
Thermal Resistance, Junction to Lead (Note 1) (Note 2)	R <sub>θJL</sub>	280 332	°C/W
Junction and Storage Temperature Range	T <sub>J</sub> , T <sub>stg</sub>	-55 to +150	°C

**THERMAL CHARACTERISTICS (SC-75) (DTC114EE)**

Total Device Dissipation T <sub>A</sub> = 25°C (Note 1) (Note 2) Derate above 25°C (Note 1) (Note 2)	P <sub>D</sub>	200 300 1.6 2.4	mW mW/°C
Thermal Resistance, Junction to Ambient (Note 1) (Note 2)	R <sub>θJA</sub>	600 400	°C/W
Junction and Storage Temperature Range	T <sub>J</sub> , T <sub>stg</sub>	-55 to +150	°C

**THERMAL CHARACTERISTICS (SOT-723) (DTC114EM3)**

Total Device Dissipation T <sub>A</sub> = 25°C (Note 1) (Note 2) Derate above 25°C (Note 1) (Note 2)	P <sub>D</sub>	260 600 2.0 4.8	mW mW/°C
Thermal Resistance, Junction to Ambient (Note 1) (Note 2)	R <sub>θJA</sub>	480 205	°C/W
Junction and Storage Temperature Range	T <sub>J</sub> , T <sub>stg</sub>	-55 to +150	°C

- FR-4 @ Minimum Pad.
- FR-4 @ 1.0 x 1.0 Inch Pad.
- FR-4 @ 100 mm<sup>2</sup>, 1 oz. copper traces, still air.
- FR-4 @ 500 mm<sup>2</sup>, 1 oz. copper traces, still air.

**Table 2. THERMAL CHARACTERISTICS**

Characteristic	Symbol	Max	Unit
<b>THERMAL CHARACTERISTICS (SOT-1123) (NSBC114EF3)</b>			
Total Device Dissipation $T_A = 25^\circ\text{C}$ (Note 3) (Note 4) Derate above $25^\circ\text{C}$ (Note 3) (Note 4)	$P_D$	254 297 2.0 2.4	mW mW/ $^\circ\text{C}$
Thermal Resistance, Junction to Ambient (Note 3) (Note 4)	$R_{\theta JA}$	493 421	$^\circ\text{C/W}$
Thermal Resistance, Junction to Lead (Note 3)	$R_{\theta JL}$	193	$^\circ\text{C/W}$
Junction and Storage Temperature Range	$T_J, T_{stg}$	-55 to +150	$^\circ\text{C}$

- FR-4 @ Minimum Pad.
- FR-4 @ 1.0 x 1.0 Inch Pad.
- FR-4 @ 100 mm<sup>2</sup>, 1 oz. copper traces, still air.
- FR-4 @ 500 mm<sup>2</sup>, 1 oz. copper traces, still air.

**Table 3. ELECTRICAL CHARACTERISTICS** ( $T_A = 25^\circ\text{C}$ , unless otherwise noted)

Characteristic	Symbol	Min	Typ	Max	Unit
<b>OFF CHARACTERISTICS</b>					
Collector-Base Cutoff Current ( $V_{CB} = 50\text{ V}, I_E = 0$ )	$I_{CBO}$	-	-	100	nAdc
Collector-Emitter Cutoff Current ( $V_{CE} = 50\text{ V}, I_B = 0$ )	$I_{CEO}$	-	-	500	nAdc
Emitter-Base Cutoff Current ( $V_{EB} = 6.0\text{ V}, I_C = 0$ )	$I_{EBO}$	-	-	0.5	mAdc
Collector-Base Breakdown Voltage ( $I_C = 10\ \mu\text{A}, I_E = 0$ )	$V_{(BR)CBO}$	50	-	-	Vdc
Collector-Emitter Breakdown Voltage (Note 5) ( $I_C = 2.0\text{ mA}, I_B = 0$ )	$V_{(BR)CEO}$	50	-	-	Vdc
<b>ON CHARACTERISTICS</b>					
DC Current Gain (Note 5) ( $I_C = 5.0\text{ mA}, V_{CE} = 10\text{ V}$ )	$h_{FE}$	35	60	-	
Collector-Emitter Saturation Voltage (Note 5) ( $I_C = 10\text{ mA}, I_B = 0.3\text{ mA}$ )	$V_{CE(sat)}$	-	-	0.25	Vdc
Input Voltage (off) ( $V_{CE} = 5.0\text{ V}, I_C = 100\ \mu\text{A}$ )	$V_{i(off)}$	-	1.2	0.8	Vdc
Input Voltage (on) ( $V_{CE} = 0.3\text{ V}, I_C = 10\text{ mA}$ )	$V_{i(on)}$	2.5	1.8	-	Vdc
Output Voltage (on) ( $V_{CC} = 5.0\text{ V}, V_B = 2.5\text{ V}, R_L = 1.0\text{ k}\Omega$ )	$V_{OL}$	-	-	0.2	Vdc
Output Voltage (off) ( $V_{CC} = 5.0\text{ V}, V_B = 0.5\text{ V}, R_L = 1.0\text{ k}\Omega$ )	$V_{OH}$	4.9	-	-	Vdc
Input Resistor	R1	7.0	10	13	k $\Omega$
Resistor Ratio	$R_1/R_2$	0.8	1.0	1.2	

Product parametric performance is indicated in the Electrical Characteristics for the listed test conditions, unless otherwise noted. Product performance may not be indicated by the Electrical Characteristics if operated under different conditions.

- Pulsed Condition: Pulse Width = 300  $\mu\text{sec}$ , Duty Cycle  $\leq 2\%$ .

TYPICAL CHARACTERISTICS  
MUN2211, MMUN2211L, MUN5211, DTC114EE, DTC114EM3

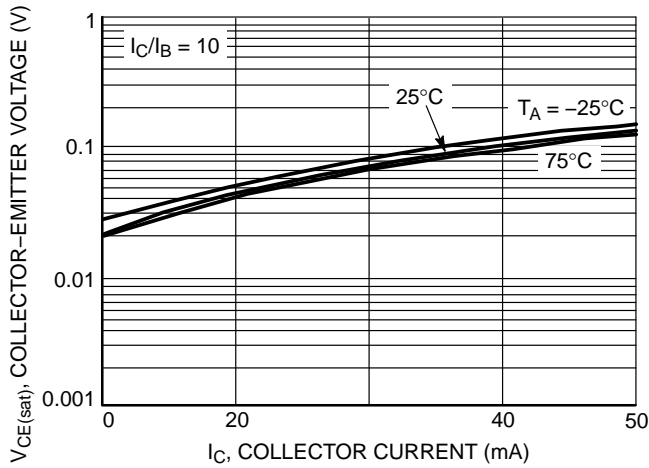

Figure 2.  $V_{CE(sat)}$  vs.  $I_C$

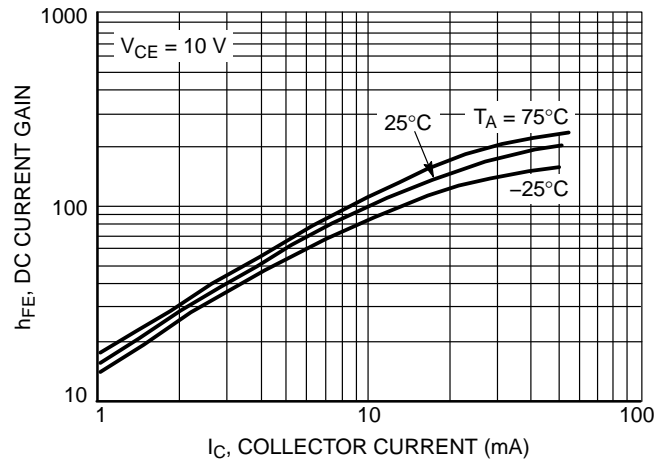

Figure 3. DC Current Gain

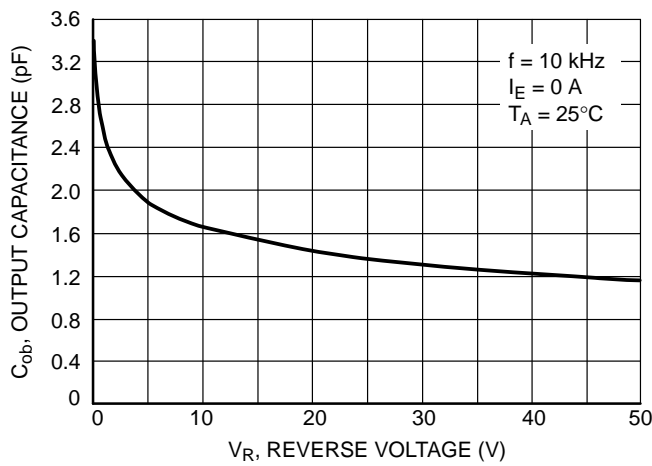

Figure 4. Output Capacitance

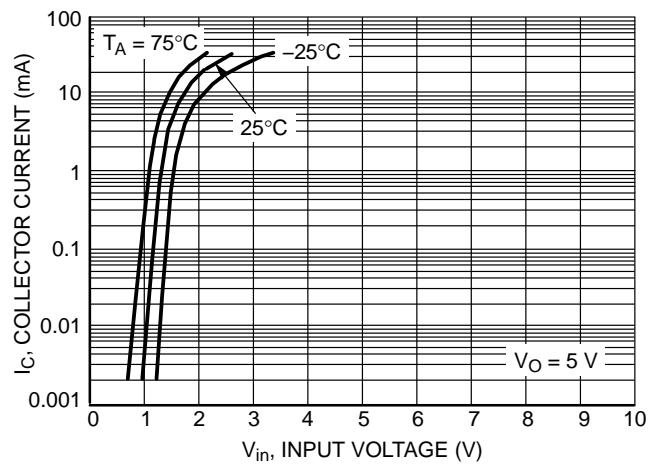

Figure 5. Output Current vs. Input Voltage

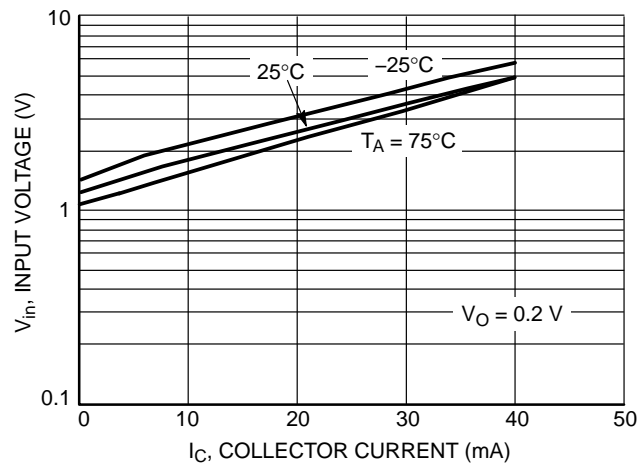

Figure 6. Input Voltage vs. Output Current

TYPICAL CHARACTERISTICS – NSBC114EF3

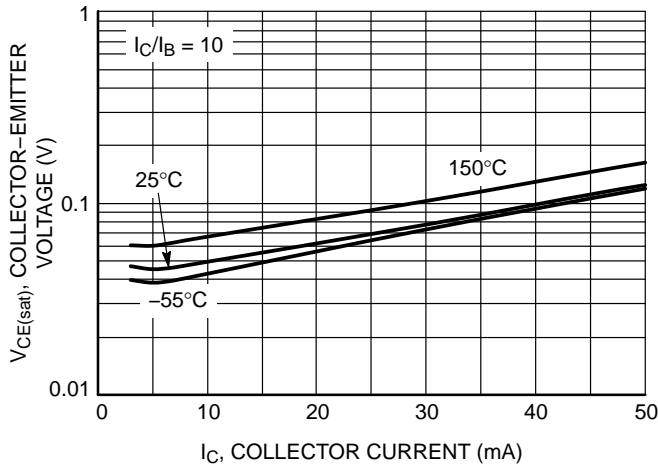

Figure 7.  $V_{CE(sat)}$  vs.  $I_C$

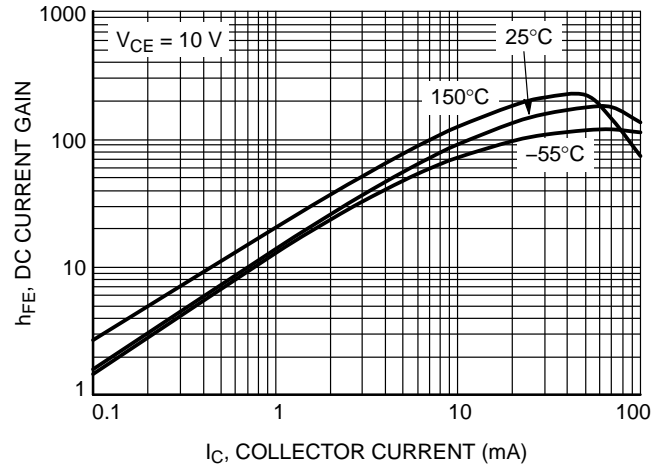

Figure 8. DC Current Gain

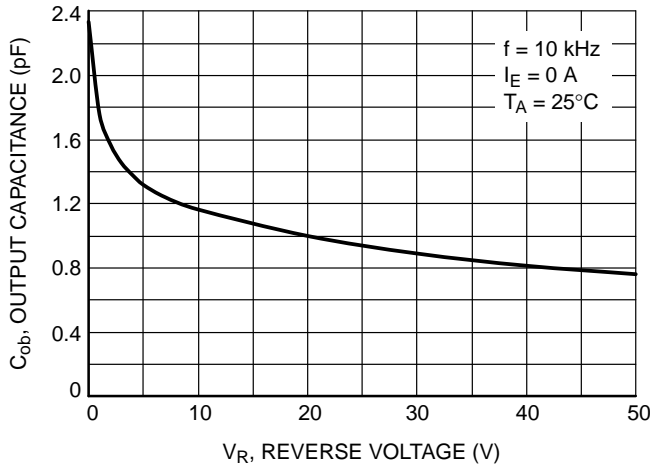

Figure 9. Output Capacitance

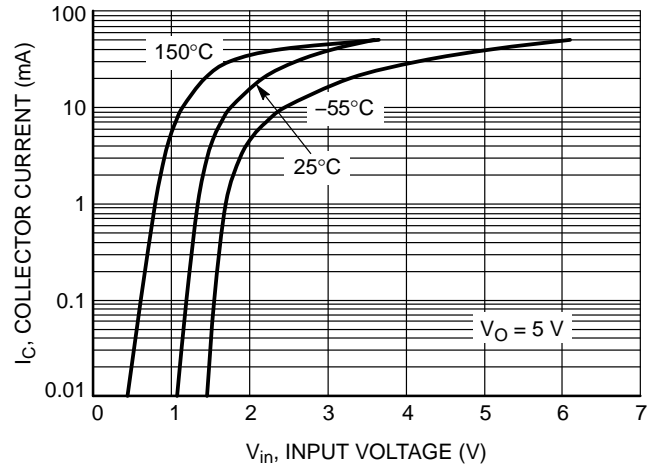

Figure 10. Output Current vs. Input Voltage

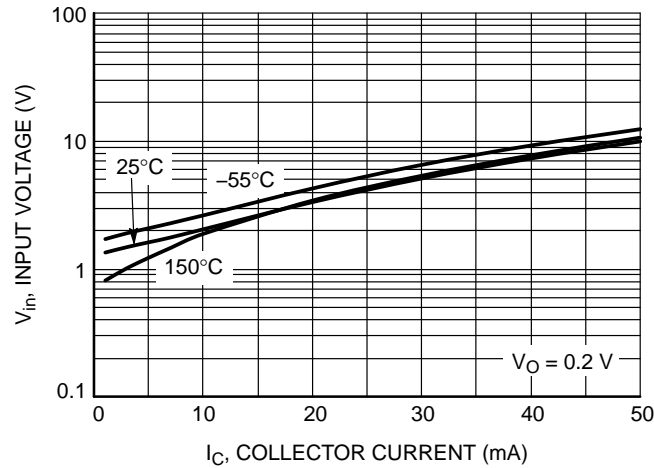
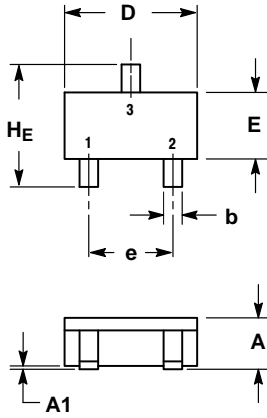

Figure 11. Input Voltage vs. Output Current

PACKAGE DIMENSIONS

SC-59  
CASE 318D-04  
ISSUE H



- NOTES:  
1. DIMENSIONING AND TOLERANCING PER ANSI Y14.5M, 1982.  
2. CONTROLLING DIMENSION: MILLIMETER.

DIM	MILLIMETERS			INCHES		
	MIN	NOM	MAX	MIN	NOM	MAX
A	1.00	1.15	1.30	0.039	0.045	0.051
A1	0.01	0.06	0.10	0.001	0.002	0.004
b	0.35	0.43	0.50	0.014	0.017	0.020
c	0.09	0.14	0.18	0.003	0.005	0.007
D	2.70	2.90	3.10	0.106	0.114	0.122
E	1.30	1.50	1.70	0.051	0.059	0.067
e	1.70	1.90	2.10	0.067	0.075	0.083
L	0.20	0.40	0.60	0.008	0.016	0.024
HE	2.50	2.80	3.00	0.099	0.110	0.118

- STYLE 1:  
PIN 1. BASE  
2. EMITTER  
3. COLLECTOR

SOLDERING FOOTPRINT\*

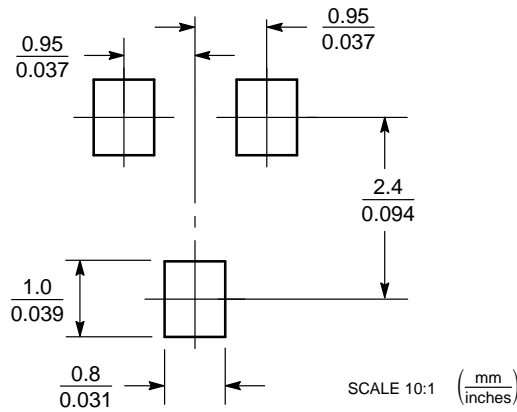

\*For additional information on our Pb-Free strategy and soldering details, please download the ON Semiconductor Soldering and Mounting Techniques Reference Manual, SOLDERRM/D.

PACKAGE DIMENSIONS

SOT-23 (TO-236)  
CASE 318-08  
ISSUE AR

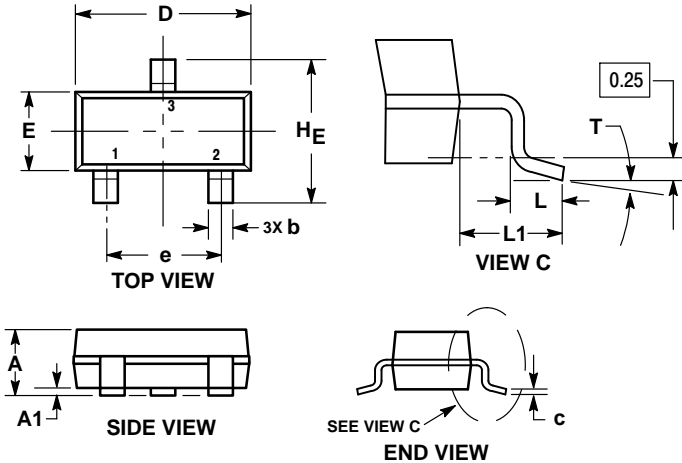

- NOTES:
1. DIMENSIONING AND TOLERANCING PER ASME Y14.5M, 1994.
  2. CONTROLLING DIMENSION: MILLIMETERS.
  3. MAXIMUM LEAD THICKNESS INCLUDES LEAD FINISH. MINIMUM LEAD THICKNESS IS THE MINIMUM THICKNESS OF THE BASE MATERIAL.
  4. DIMENSIONS D AND E DO NOT INCLUDE MOLD FLASH, PROTRUSIONS, OR GATE BURRS.

DIM	MILLIMETERS			INCHES		
	MIN	NOM	MAX	MIN	NOM	MAX
A	0.89	1.00	1.11	0.035	0.039	0.044
A1	0.01	0.06	0.10	0.000	0.002	0.004
b	0.37	0.44	0.50	0.015	0.017	0.020
c	0.08	0.14	0.20	0.003	0.006	0.008
D	2.80	2.90	3.04	0.110	0.114	0.120
E	1.20	1.30	1.40	0.047	0.051	0.055
e	1.78	1.90	2.04	0.070	0.075	0.080
L	0.30	0.43	0.55	0.012	0.017	0.022
L1	0.35	0.54	0.69	0.014	0.021	0.027
HE	2.10	2.40	2.64	0.083	0.094	0.104
T	0°	---	10°	0°	---	10°

- STYLE 6:  
PIN 1: BASE  
2: EMITTER  
3: COLLECTOR

RECOMMENDED  
SOLDERING FOOTPRINT\*

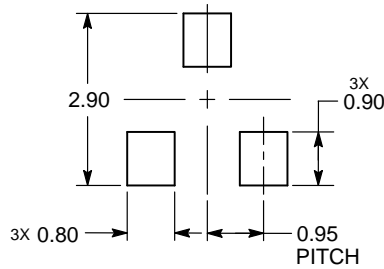

DIMENSIONS: MILLIMETERS

\*For additional information on our Pb-Free strategy and soldering details, please download the ON Semiconductor Soldering and Mounting Techniques Reference Manual, SOLDERRM/D.



PACKAGE DIMENSIONS

SC-70 (SOT-323)  
CASE 419-04  
ISSUE N

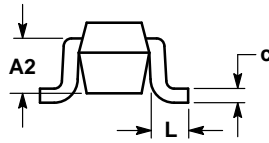
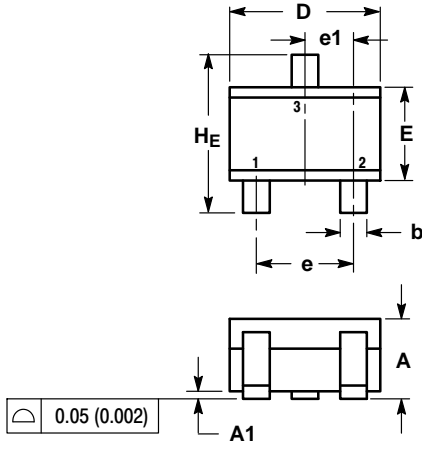

NOTES:

1. DIMENSIONING AND TOLERANCING PER ANSI Y14.5M, 1982.
2. CONTROLLING DIMENSION: INCH.

DIM	MILLIMETERS			INCHES		
	MIN	NOM	MAX	MIN	NOM	MAX
A	0.80	0.90	1.00	0.032	0.035	0.040
A1	0.00	0.05	0.10	0.000	0.002	0.004
A2	0.70 REF			0.028 REF		
b	0.30	0.35	0.40	0.012	0.014	0.016
c	0.10	0.18	0.25	0.004	0.007	0.010
D	1.80	2.10	2.20	0.071	0.083	0.087
E	1.15	1.24	1.35	0.045	0.049	0.053
e	1.20	1.30	1.40	0.047	0.051	0.055
e1	0.65 BSC			0.026 BSC		
L	0.20	0.38	0.56	0.008	0.015	0.022
HE	2.00	2.10	2.40	0.079	0.083	0.095

STYLE 3:  
PIN 1. BASE  
2. EMITTER  
3. COLLECTOR

SOLDERING FOOTPRINT\*

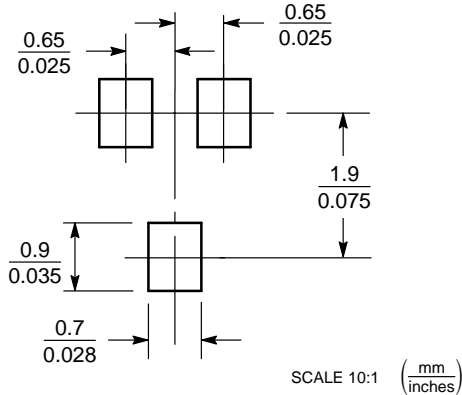

\*For additional information on our Pb-Free strategy and soldering details, please download the ON Semiconductor Soldering and Mounting Techniques Reference Manual, SOLDERRM/D.

PACKAGE DIMENSIONS

SC-75/SOT-416  
CASE 463  
ISSUE G

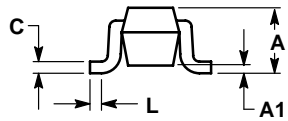
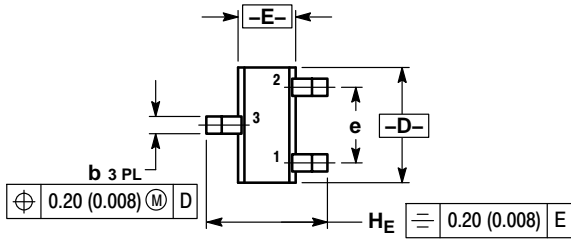

- NOTES:  
1. DIMENSIONING AND TOLERANCING PER ANSI Y14.5M, 1982.  
2. CONTROLLING DIMENSION: MILLIMETER.

DIM	MILLIMETERS			INCHES		
	MIN	NOM	MAX	MIN	NOM	MAX
A	0.70	0.80	0.90	0.027	0.031	0.035
A1	0.00	0.05	0.10	0.000	0.002	0.004
b	0.15	0.20	0.30	0.006	0.008	0.012
C	0.10	0.15	0.25	0.004	0.006	0.010
D	1.55	1.60	1.65	0.061	0.063	0.065
E	0.70	0.80	0.90	0.027	0.031	0.035
e	1.00 BSC			0.04 BSC		
L	0.10	0.15	0.20	0.004	0.006	0.008
HE	1.50	1.60	1.70	0.060	0.063	0.067

- STYLE 1:  
PIN 1. BASE  
2. EMITTER  
3. COLLECTOR

SOLDERING FOOTPRINT\*

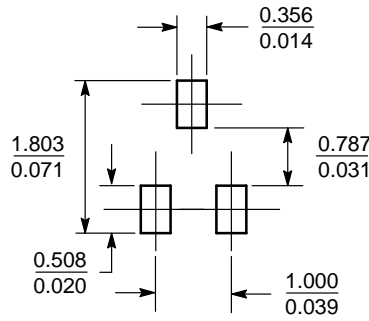

SCALE 10:1 (mm/inches)

\*For additional information on our Pb-Free strategy and soldering details, please download the ON Semiconductor Soldering and Mounting Techniques Reference Manual, SOLDERRM/D.

PACKAGE DIMENSIONS

SOT-723  
CASE 631AA  
ISSUE D

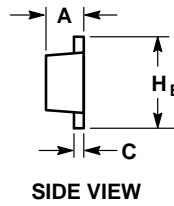
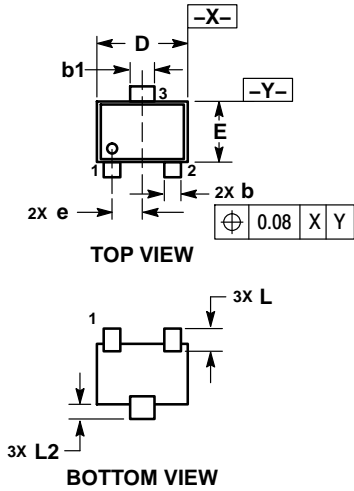

NOTES:

1. DIMENSIONING AND TOLERANCING PER ASME Y14.5M, 1994.
2. CONTROLLING DIMENSION: MILLIMETERS.
3. MAXIMUM LEAD THICKNESS INCLUDES LEAD FINISH. MINIMUM LEAD THICKNESS IS THE MINIMUM THICKNESS OF BASE MATERIAL.
4. DIMENSIONS D AND E DO NOT INCLUDE MOLD FLASH, PROTRUSIONS OR GATE BURRS.

DIM	MILLIMETERS		
	MIN	NOM	MAX
A	0.45	0.50	0.55
b	0.15	0.21	0.27
b1	0.25	0.31	0.37
C	0.07	0.12	0.17
D	1.15	1.20	1.25
E	0.75	0.80	0.85
e	0.40 BSC		
H E	1.15	1.20	1.25
L	0.29 REF		
L2	0.15	0.20	0.25

STYLE 1:

1. BASE
2. EMITTER
3. COLLECTOR

RECOMMENDED  
SOLDERING FOOTPRINT\*

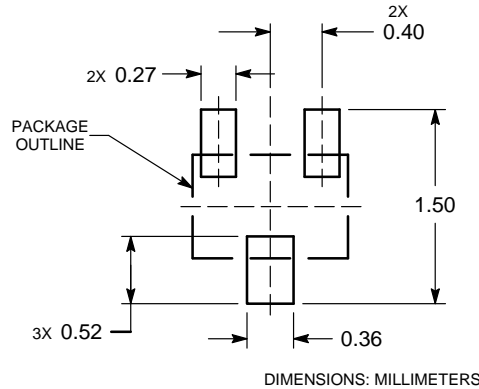

\*For additional information on our Pb-Free strategy and soldering details, please download the ON Semiconductor Soldering and Mounting Techniques Reference Manual, SOLDERRM/D.

PACKAGE DIMENSIONS

SOT-1123  
CASE 524AA  
ISSUE C

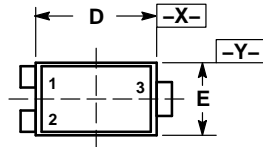

TOP VIEW

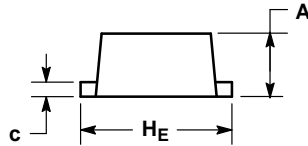

SIDE VIEW

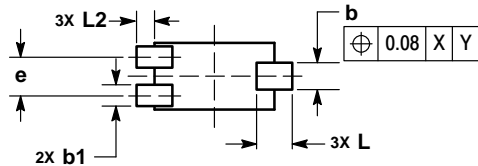

BOTTOM VIEW

NOTES:

1. DIMENSIONING AND TOLERANCING PER ASME Y14.5M, 1994.
2. CONTROLLING DIMENSION: MILLIMETERS.
3. MAXIMUM LEAD THICKNESS INCLUDES LEAD FINISH. MINIMUM LEAD THICKNESS IS THE MINIMUM THICKNESS OF BASE MATERIAL.
4. DIMENSIONS D AND E DO NOT INCLUDE MOLD FLASH, PROTRUSIONS, OR GATE BURRS.

DIM	MILLIMETERS	
	MIN	MAX
A	0.34	0.40
b	0.15	0.28
b1	0.10	0.20
c	0.07	0.17
D	0.75	0.85
E	0.55	0.65
e	0.35	0.40
H <sub>E</sub>	0.95	1.05
L	0.185	REF
L2	0.05	0.15

STYLE 1:

1. BASE
2. EMITTER
3. COLLECTOR

SOLDERING FOOTPRINT\*

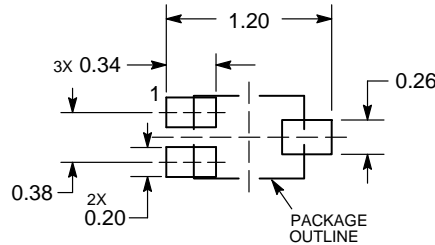

DIMENSIONS: MILLIMETERS

\*For additional information on our Pb-Free strategy and soldering details, please download the ON Semiconductor Soldering and Mounting Techniques Reference Manual, SOLDERRM/D.

ON Semiconductor and are trademarks of Semiconductor Components Industries, LLC dba ON Semiconductor or its subsidiaries in the United States and/or other countries. ON Semiconductor owns the rights to a number of patents, trademarks, copyrights, trade secrets, and other intellectual property. A listing of ON Semiconductor's product/patent coverage may be accessed at [www.onsemi.com/site/pdf/Patent-Marking.pdf](http://www.onsemi.com/site/pdf/Patent-Marking.pdf). ON Semiconductor reserves the right to make changes without further notice to any products herein. ON Semiconductor makes no warranty, representation or guarantee regarding the suitability of its products for any particular purpose, nor does ON Semiconductor assume any liability arising out of the application or use of any product or circuit, and specifically disclaims any and all liability, including without limitation special, consequential or incidental damages. Buyer is responsible for its products and applications using ON Semiconductor products, including compliance with all laws, regulations and safety requirements or standards, regardless of any support or applications information provided by ON Semiconductor. "Typical" parameters which may be provided in ON Semiconductor data sheets and/or specifications can and do vary in different applications and actual performance may vary over time. All operating parameters, including "Typicals" must be validated for each customer application by customer's technical experts. ON Semiconductor does not convey any license under its patent rights nor the rights of others. ON Semiconductor products are not designed, intended, or authorized for use as a critical component in life support systems or any FDA Class 3 medical devices or medical devices with a same or similar classification in a foreign jurisdiction or any devices intended for implantation in the human body. Should Buyer purchase or use ON Semiconductor products for any such unintended or unauthorized application, Buyer shall indemnify and hold ON Semiconductor and its officers, employees, subsidiaries, affiliates, and distributors harmless against all claims, costs, damages, and expenses, and reasonable attorney fees arising out of, directly or indirectly, any claim of personal injury or death associated with such unintended or unauthorized use, even if such claim alleges that ON Semiconductor was negligent regarding the design or manufacture of the part. ON Semiconductor is an Equal Opportunity/Affirmative Action Employer. This literature is subject to all applicable copyright laws and is not for resale in any manner.

PUBLICATION ORDERING INFORMATION

**LITERATURE FULFILLMENT:**  
Literature Distribution Center for ON Semiconductor  
19521 E. 32nd Pkwy, Aurora, Colorado 80011 USA  
**Phone:** 303-675-2175 or 800-344-3860 Toll Free USA/Canada  
**Fax:** 303-675-2176 or 800-344-3867 Toll Free USA/Canada  
**Email:** [orderlit@onsemi.com](mailto:orderlit@onsemi.com)

**N. American Technical Support:** 800-282-9855 Toll Free  
USA/Canada  
**Europe, Middle East and Africa Technical Support:**  
Phone: 421 33 790 2910  
**Japan Customer Focus Center**  
Phone: 81-3-5817-1050

**ON Semiconductor Website:** [www.onsemi.com](http://www.onsemi.com)  
**Order Literature:** <http://www.onsemi.com/orderlit>

For additional information, please contact your local Sales Representative