

DIGITRON SEMICONDUCTORS

MUR805-MUR860

8A SCHOTTKY RECTIFIER

MAXIMUM RATINGS

Rating	Symbol	MUR						Unit
		805	810	815	820	840	860	
Peak repetitive reverse voltage	V_{RRM}							V
Working peak reverse voltage	V_{RWM}	50	100	150	200	400	600	
DC blocking voltage	V_R							
Average rectified forward current (Rated V_R) ⁽¹⁾	$I_{F(AV)}$	8.0 @ $T_C = 150^\circ\text{C}$						A
Peak repetitive forward current (Rated V_R) Square wave, 20 kHz	I_{FM}	16 @ $T_C = 150^\circ\text{C}$						A
Non-repetitive peak surge current (surge applied at rated load conditions, halfwave, single phase, 60Hz)	I_{FSM}	100						A
Operating and storage junction temperature range	T_J, T_{stg}	-65 to +175						$^\circ\text{C}$
Maximum thermal resistance	$R_{\theta JC}$					3.0		$^\circ\text{C}/\text{W}$
Junction to case	$R_{\theta JA}$					2.0		
Junction to ambient		73						

ELECTRICAL CHARACTERISTICS ($T_C = 25^\circ\text{C}$ unless otherwise noted)

Parameter	Symbol	MUR						Unit
		805	810	815	820	840	860	
Maximum instantaneous forward voltage ⁽¹⁾ ($I_F = 8.0\text{A}, T_C = 150^\circ\text{C}$) ($I_F = 8.0\text{A}, T_C = 25^\circ\text{C}$)	V_F	0.895 0.975				1.00 1.30	1.20 1.50	V
Maximum instantaneous reverse current ⁽¹⁾ (Rated dc voltage, $T_C = 150^\circ\text{C}$) (Rated dc voltage, $T_C = 25^\circ\text{C}$)	I_R	250 5.0				500 10		μA
Maximum reverse recovery time ($I_F = 1.0\text{A}, di/dt = 50\text{A}/\mu\text{s}$) ($I_F = 0.5\text{A}, I_R = 1.0\text{A}, I_{REC} = 0.25\text{A}$)	t_{rr}	35 25				60 50		ns

Note 1: Pulse test: Pulse width = 300 μs , duty cycle = 2.0%.

DIGITRON SEMICONDUCTORS

MUR805-MUR860

8A SCHOTTKY RECTIFIER

MECHANICAL CHARACTERISTICS

Case	TO-220AC
Marking	Alpha-numeric
Pin out	See below

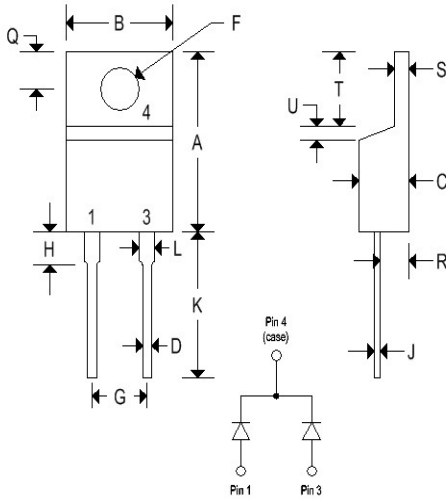

	TO-220AC			
	Inches		Millimeters	
	Min	Max	Min	Max
A	0.595	0.620	15.110	15.750
B	0.380	0.405	9.650	10.290
C	0.160	0.190	4.060	4.820
D	0.142	0.147	3.610	3.730
F	0.142	0.147	3.610	3.730
G	0.190	0.210	4.830	5.330
H	0.110	0.130	2.790	3.300
J	0.018	0.025	0.460	0.640
K	0.500	0.562	12.700	14.270
L	0.045	0.050	1.140	1.270
Q	0.100	0.120	2.540	3.040
R	0.080	0.110	2.040	2.790
S	0.045	0.055	1.140	1.390
T	0.235	0.255	5.970	6.480
U	0.030	0.050	0.760	1.270

Available Non-RoHS (standard) or RoHS compliant (add PBF suffix).

Available as "HR" (high reliability) screened per MIL-PRF-19500, JANTX level. Add "HR" suffix to base part number.

DIGITRON SEMICONDUCTORS

MUR805-MUR860 10A SCHOTTKY RECTIFIER

MUR805, MUR810, MUR815, MUR820

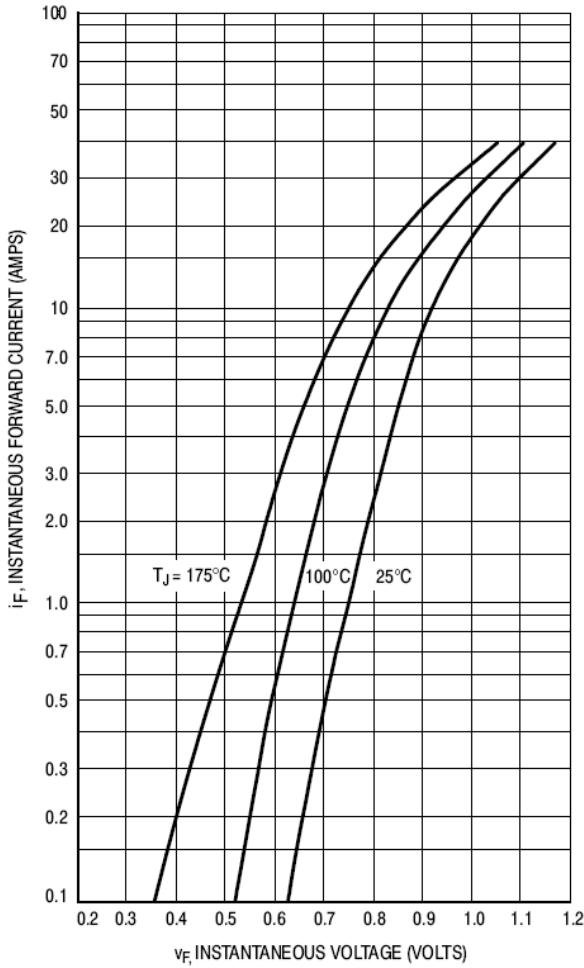

Figure 1. Typical Forward Voltage

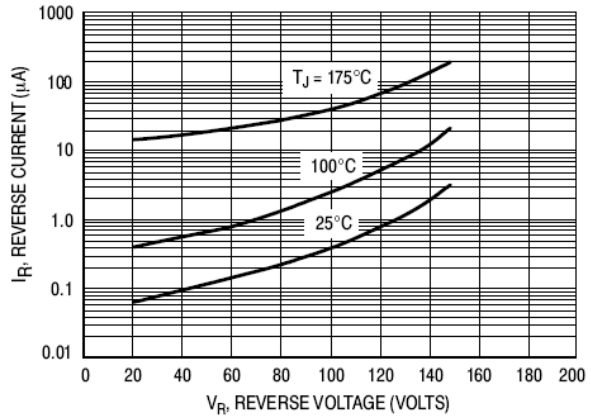

Figure 2. Typical Reverse Current*

* The curves shown are typical for the highest voltage device in the grouping. Typical reverse current for lower voltage selections can be estimated from these same curves if V_R is sufficiently below rated V_R .

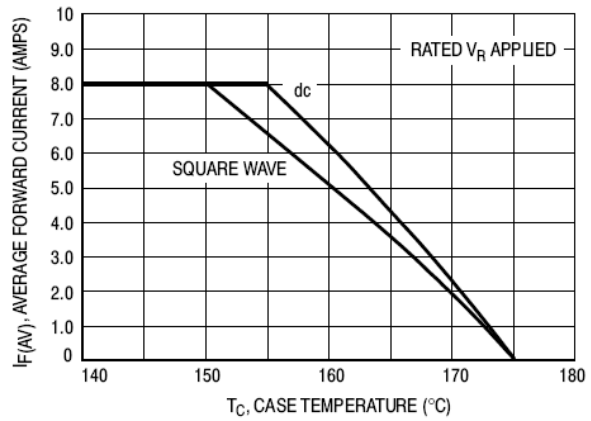

Figure 3. Current Derating, Case

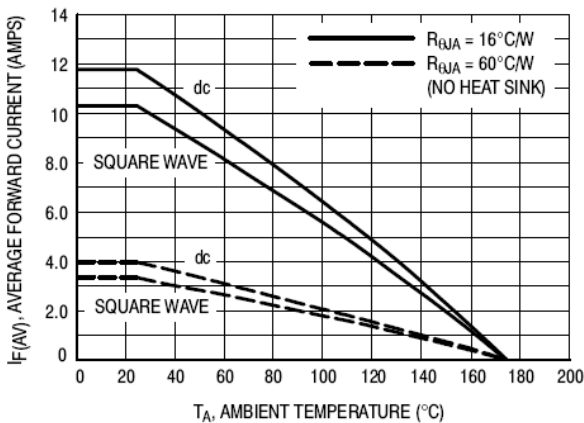

Figure 4. Current Derating, Ambient

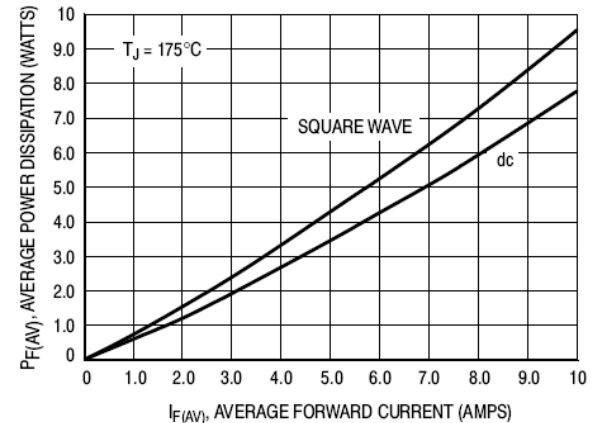

Figure 5. Power Dissipation

DIGITRON SEMICONDUCTORS

MUR805-MUR860 10A SCHOTTKY RECTIFIER

MUR840

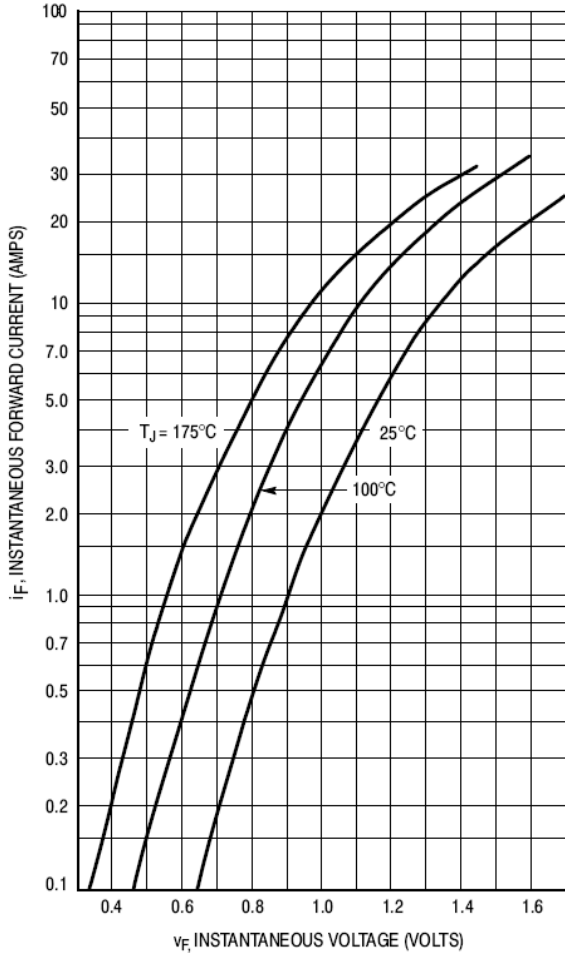

Figure 6. Typical Forward Voltage

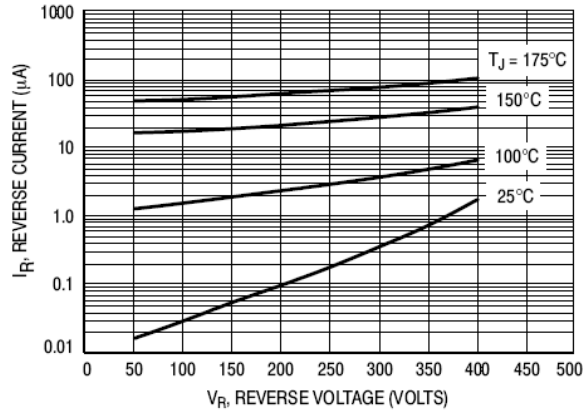

Figure 7. Typical Reverse Current*

* The curves shown are typical for the highest voltage device in the grouping. Typical reverse current for lower voltage selections can be estimated from these same curves if V_R is sufficiently below rated V_R .

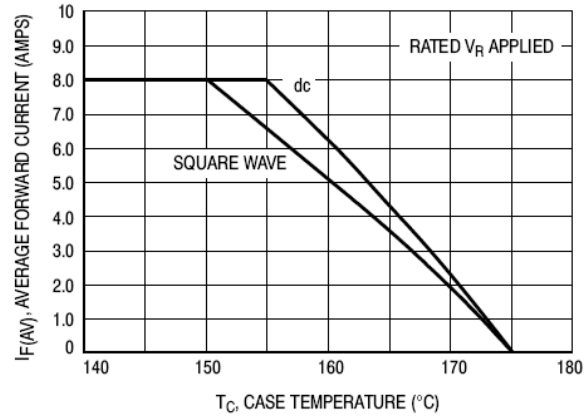

Figure 8. Current Derating, Case

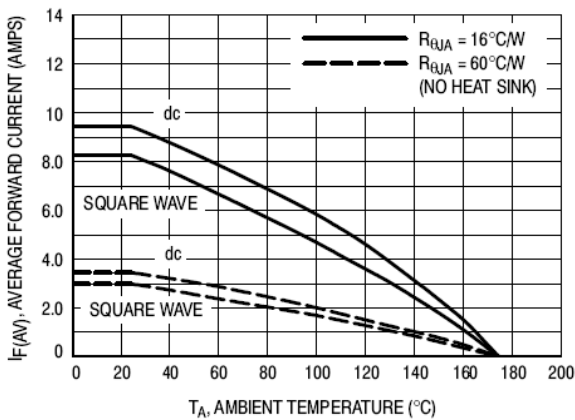

Figure 9. Current Derating, Ambient

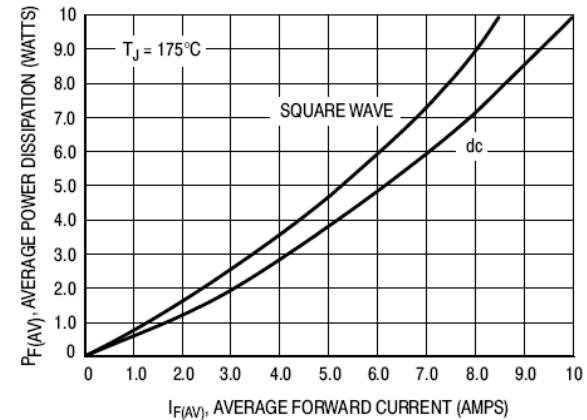

Figure 10. Power Dissipation

DIGITRON SEMICONDUCTORS

MUR805-MUR860 10A SCHOTTKY RECTIFIER

MUR860

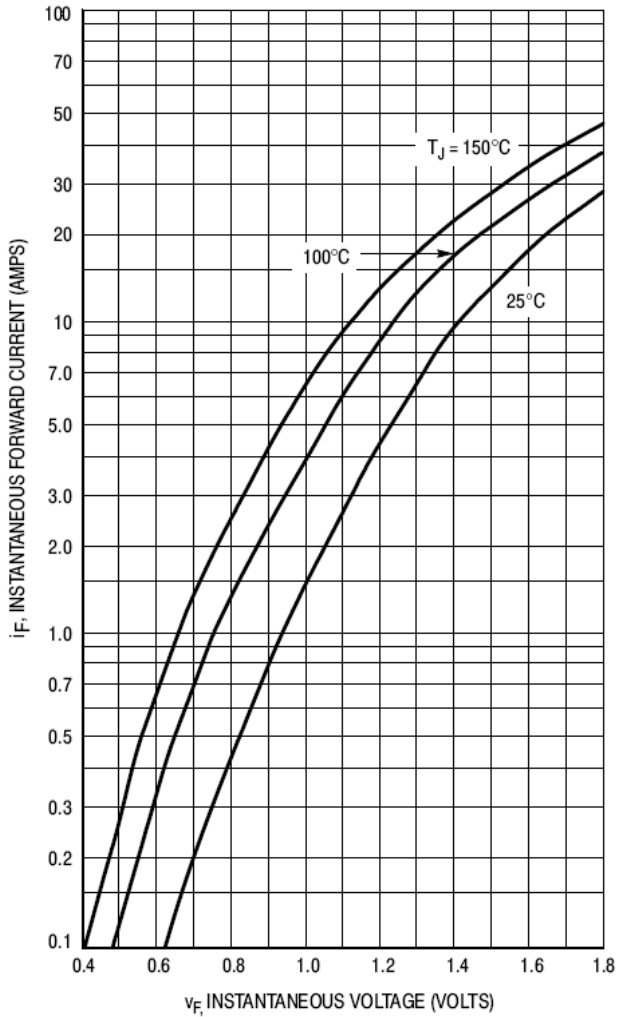

Figure 11. Typical Forward Voltage

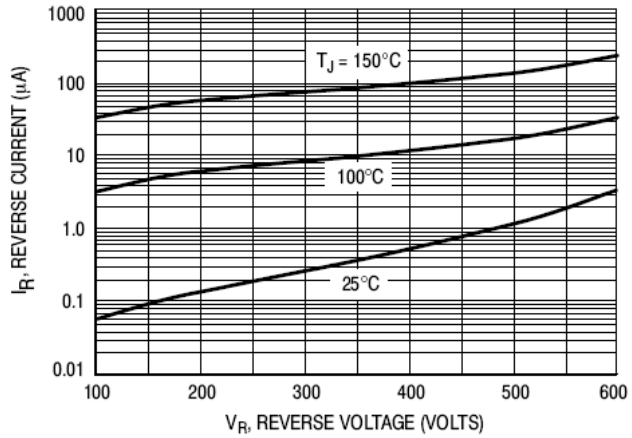

Figure 12. Typical Reverse Current*

* The curves shown are typical for the highest voltage device in the grouping. Typical reverse current for lower voltage selections can be estimated from these same curves if V_R is sufficiently below rated V_R .

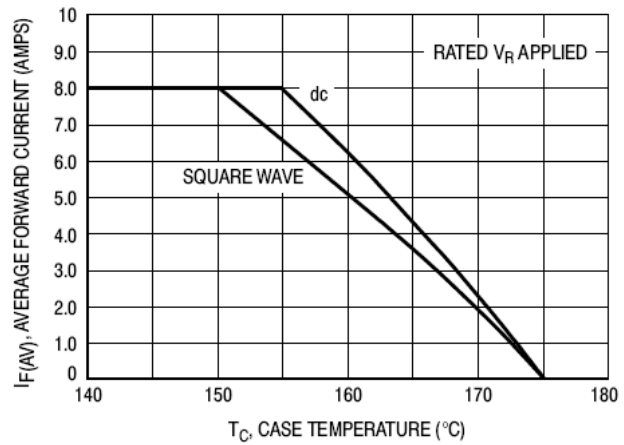

Figure 13. Current Derating, Case

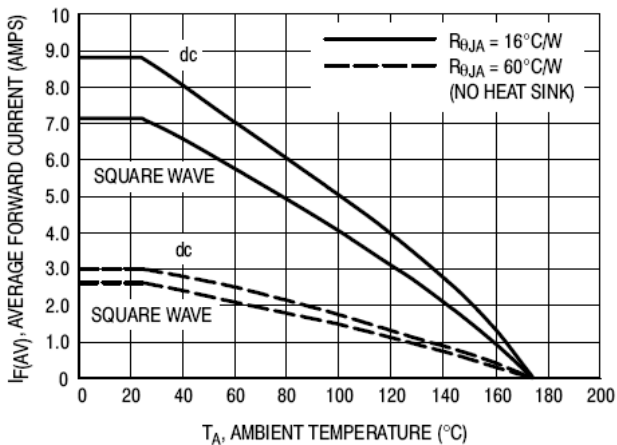

Figure 14. Current Derating, Ambient

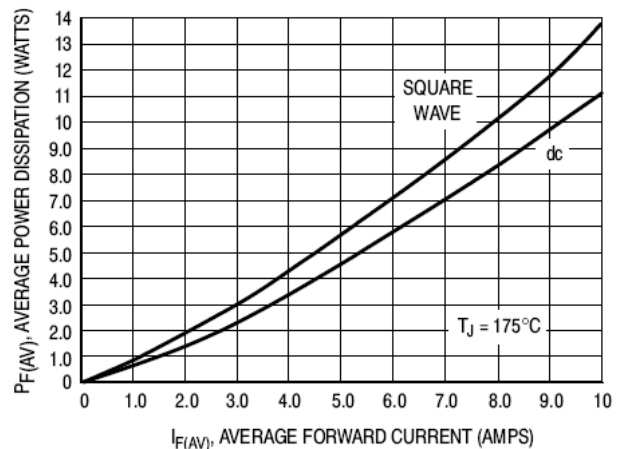

Figure 15. Power Dissipation

DIGITRON SEMICONDUCTORS

MUR805-MUR860

10A SCHOTTKY RECTIFIER

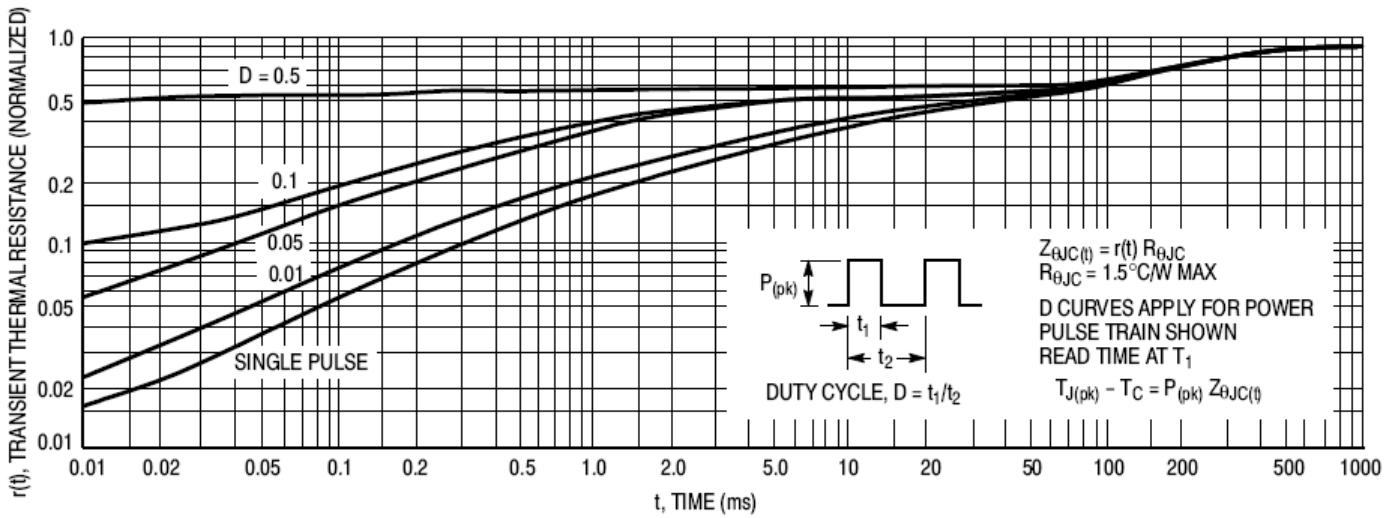

Figure 16. Thermal Response

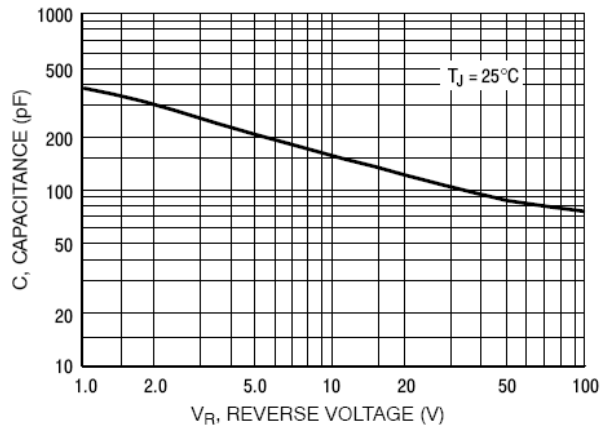

Figure 19. Typical Capacitance