

**Pb Free Plating Product**

MURB1620CTG/MURB1630CTG/MURB1640CTG/MURB1660CTG



16.0 Ampere Surface Mount Dual Common Cathode Ultra Fast Recovery Rectifier Diodes

**Features**

- ★ Matured GPP Technology
- ★ Good Soft Recovery Characteristics
- ★ Ideally Suited for Automatic Assembly
- ★ Low Forward Voltage
- ★ High Surge Current Capability
- ★ Low Leakage Current

**Applications**

- ★ Freewheeling, Snubber, Clamp
- ★ Inversion Welder
- ★ PFC&Transformer Secondary Rectifier
- ★ Plating Power Supply
- ★ Ultrasonic Cleaner and Welder
- ★ Converter & Chopper
- ★ UPS/LED SMPS/HID

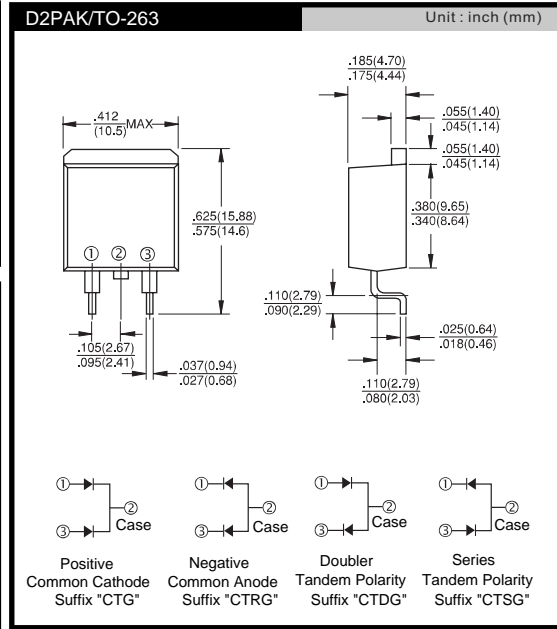

**Maximum Ratings and Electrical Characteristics** @T<sub>A</sub>=25°C unless otherwise specified

Single Phase, half wave, 60Hz, resistive or inductive load. For capacitive load, derate current by 20%.

Characteristic	Symbol	MURB1620CTG	MURB1630CTG	MURB1640CTG	MURB1660CTG	Unit
Peak Repetitive Reverse Voltage	V <sub>RRM</sub>					
Working Peak Reverse Voltage	V <sub>RWM</sub>	200	300	400	600	V
DC Blocking Voltage	V <sub>R</sub>					
RMS Reverse Voltage	V <sub>R(RMS)</sub>	140	210	280	420	V
Average Rectified Output Current @T <sub>C</sub> = 100°C	I <sub>O</sub>			16.0 8.0		A
Non-Repetitive Peak Forward Surge Current 8.3ms Single Half Sine-Wave Superimposed on Rated Load (JEDEC Method)	I <sub>FSM</sub>			150		A
Forward Voltage per diode @I <sub>F</sub> = 8.0A	V <sub>FM</sub>	0.98		1.3	1.7	V
Peak Reverse Current At Rated DC Blocking Voltage	I <sub>RM</sub>			5.0 100		μA
Reverse Recovery Time (Note 1)	t <sub>rr</sub>			35		nS
Typical Junction Capacitance (Note 2)	C <sub>J</sub>	70		50		pF
Thermal Resistance Junction to Ambient (Note 3)	R <sub>JA</sub>			30		°C/W
Thermal Resistance Junction to Lead (Note 3)	R <sub>JC</sub>			1.5		
Operating and Storage Temperature Range	T <sub>J</sub> , T <sub>STG</sub>			-55 to +150		°C

Note: 1. Measured with I<sub>F</sub> = 0.5A, I<sub>R</sub> = 1.0A, I<sub>RR</sub> = 0.25A.  
 2. Measured at 1.0 MHz and applied reverse voltage of 4.0 V DC.  
 3. Mounted on PCB with minimum recommended pad sizes per diode.

RATINGS AND CHARACTERISTICS CURVES

( $T_A=25^{\circ}\text{C}$  unless otherwise noted)

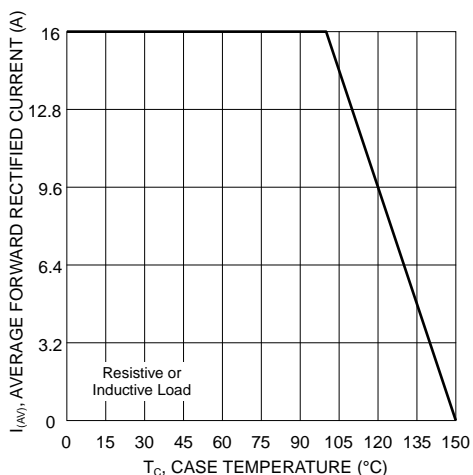

Fig. 1 Forward Current Derating Curve

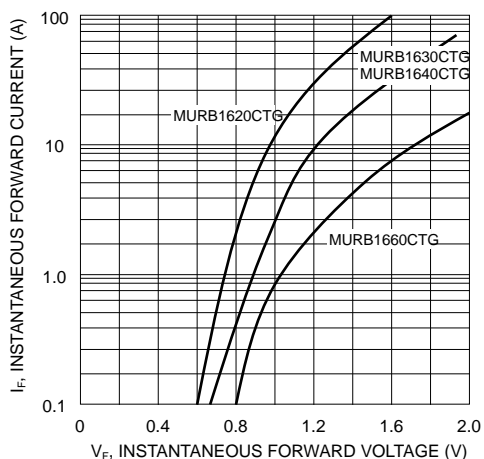

Fig. 2 Typical Forward Characteristics

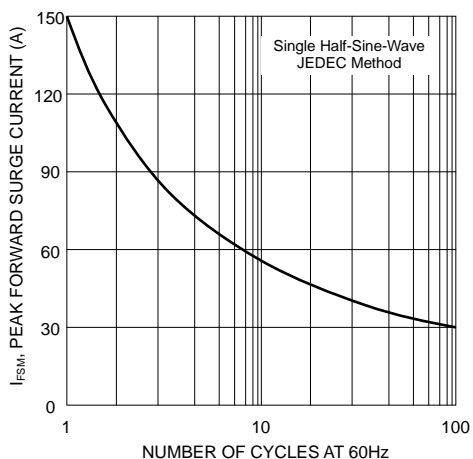

Fig. 3 Forward Surge Current Derating Curve

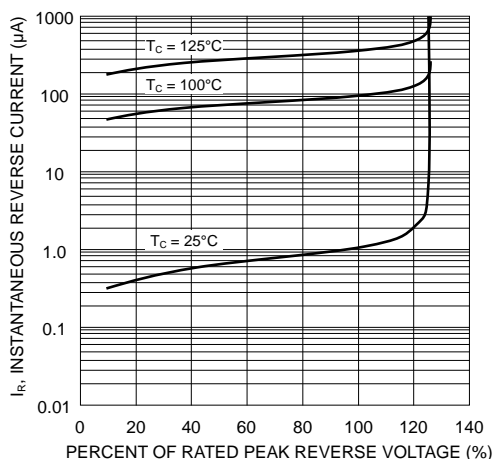

Fig. 4 Typical Reverse Characteristics

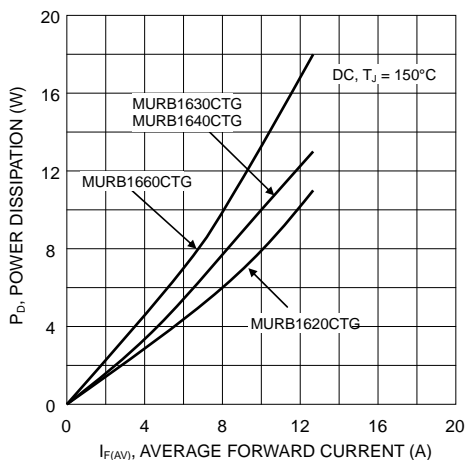

Fig. 5 Forward Power Dissipation

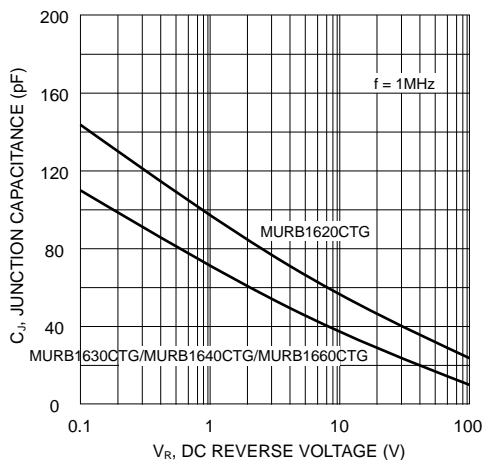

Fig. 6 Typical Junction Capacitance