

## 7.5-30GHz Frequency Multiplier

GaAs Monolithic Microwave IC

*preliminary*

### Description

The MUX-PO9824 is a frequency multiplier by 4 monolithic circuit.

It is designed for a wide range of applications, from military to commercial communication systems. The backside of the chip is both RF and DC grounds. This helps simplify the assembly process.

The circuit is manufactured with a P-HEMT process, 0.25 $\mu$ m gate length, via holes through the substrate, air bridges and electron beam gate lithography.

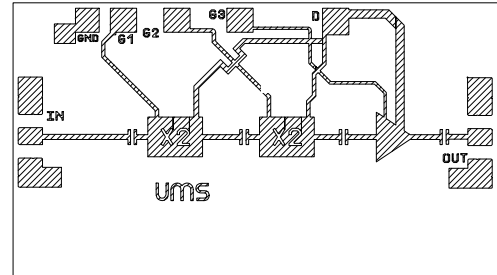

### Main Features

- Broadband performance : 6.25-8.25 GHz
- 11dBm output power for +12dBm input power
- DC power consumption, 75mA @ 3.5V (with RF)
- Chip size : 2.02 x 1.17 x 0.10 mm

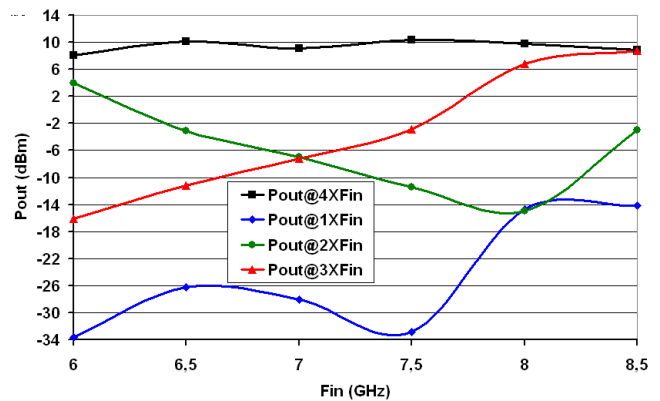

### Main Characteristics

Tamb=25°C

Symbol	Parameter	Min	Typ	Max	Unit
Fin	Input frequency range	6.25		8.25	GHz
Fout	Output frequency range	25		33	GHz
Pin	Input power		12		dBm
Pout 4xFin	Output power for +12dBm input power	8	11	14	dBm

ESD Protection : Electrostatic discharge sensitive device. Observe handling precautions !

*preliminary*

## Electrical Characteristics

These values are representative on wafer measurements that are made without bonding wires at the RF ports.

Tamb=+25°C, Vd=3.5V Vg1=Vg2=-0.9V Vg3 adjusted for Id=75mA under RF Pin=+12dBm

Symbol	Parameter	Min	Typ	Max	Unit
Fin	Input frequency range	6.25		8.25	GHz
Fout	Output frequency range	25		33	GHz
Pin	Input power		12		dBm
Pout 4xFin	Output power for +12 dBm input power	8	11	14	dBm
Pout 1xFin	Fin level at the output ( 6.25 < Fin < 8.25GHz ), for +12dBm input power		0	2	dBm
Pout 2xFin	2Fin level at the output ( 12.5 < 2Fin < 16.5GHz ), for +12dBm input power		-10	3	dBm
Pout 3xFin	3Fin level at the output ( 18.75 < 3Fin < 24.75GHz ), for +12dBm input power		0	12	dBm
Pout 5xFin	5Fin level at the output ( 31.25 < 5Fin < 41.25GHz ), for +12dBm input power		0		dBm
VSWRin	Input VSWR		2.5:1		
VSWRout	Output VSWR		2.5:1		
Id	Bias current		75		mA

A wire bond of typically 0.1 to 0.15 nH will improve the input and output matching.

## Absolute Maximum Ratings

Tamb=+25°C

Symbol	Parameter	Values	Unit
Vd	Supply voltage	4.0	V
Id	Supply current	150	mA
Pin	Input power	20	dBm
Ta	Operating temperature range	-40 to +85	°C
Tstg	Storage temperature range	-55 to +125	°C

(1) Operation of device above any one of these parameters may cause permanent damage.

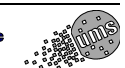

*preliminary*

**Typical on Wafer Measurements**

Bias conditions:  $T_{amb}=+25^{\circ}C$ ,  $V_d=3.5V$   $V_{g1}=V_{g2}=-0.9V$   $V_{g3}$  adjusted for  $I_d=75mA$  under RF  $P_{in}=+12dBm$

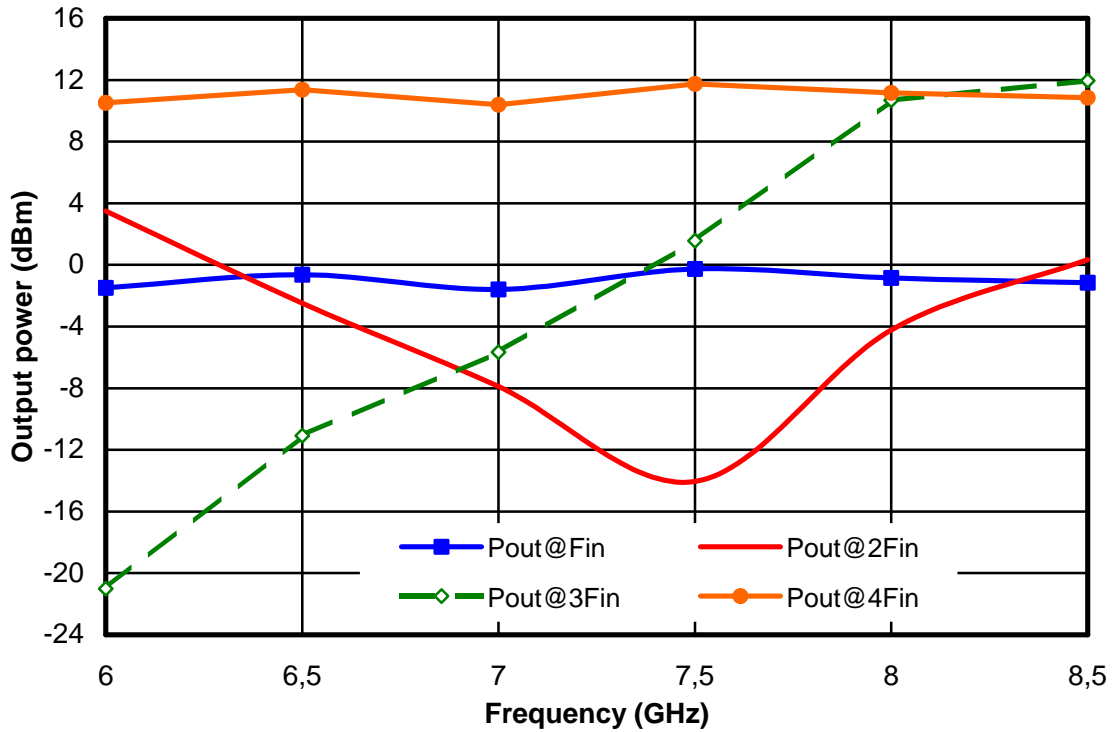

*preliminary*

## Typical In-Jig Measurements

Bias conditions:  $T_{amb}=+25^{\circ}\text{C}$ ,  $V_d=3.5\text{V}$   $P_{in}=+11\text{dBm}$  (jig losses are not corrected and are evaluated to 1.5dB at 30GHz)

Gate voltage  $V_{g1}=V_{g2}=-0.8\text{V}$   $I_d=70\text{mA}$

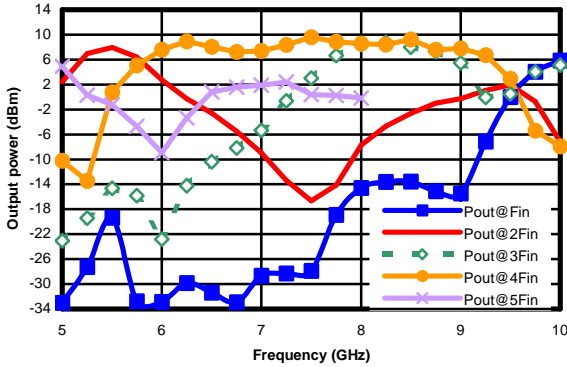

Gate voltage  $V_{g1}=V_{g2}=-0.95\text{V}$   $I_d=75\text{mA}$

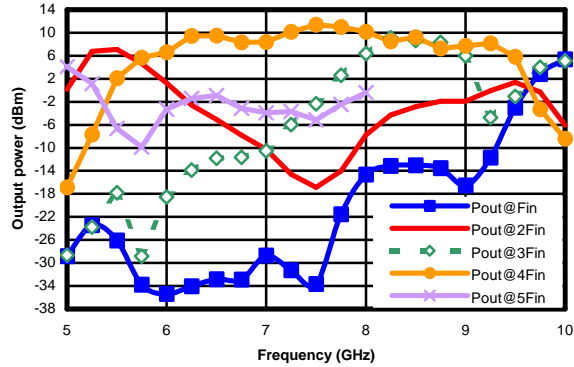

Gate voltage  $V_{g1}=V_{g2}=-1.1\text{V}$   $I_d=80\text{mA}$

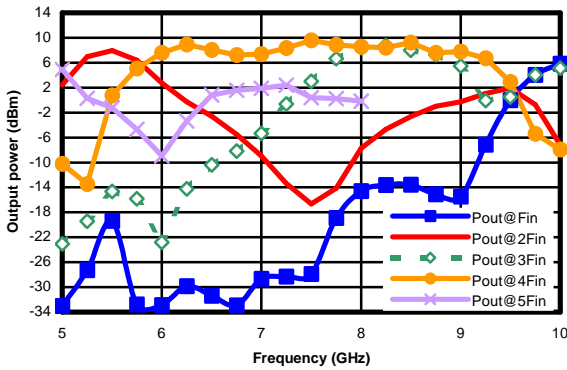

Bias conditions:  $T_{amb}=+25^{\circ}\text{C}$ ,  $V_d=3.5\text{V}$   $I_d=75\text{mA}$  under RF nominal  $P_{in}=+12\text{dBm}$   $F_{in}=7.5\text{GHz}$  (jig losses are not corrected and are evaluated to 1.5dB at 30GHz)

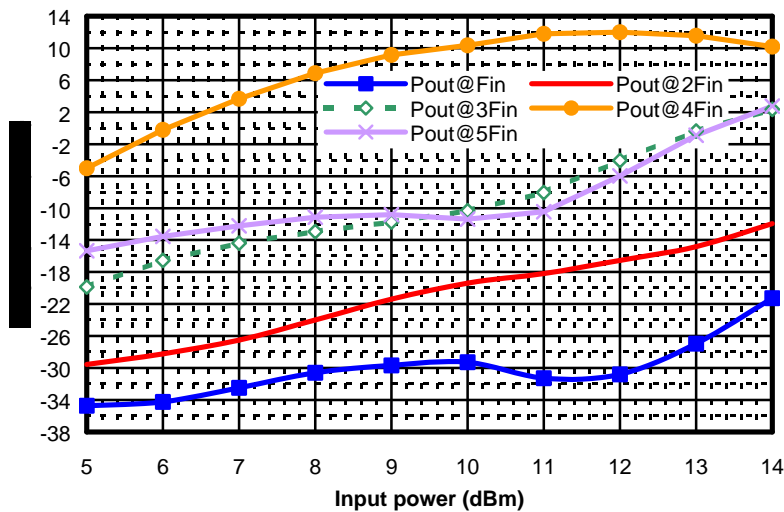

**Chip Assembly and Mechanical Data**

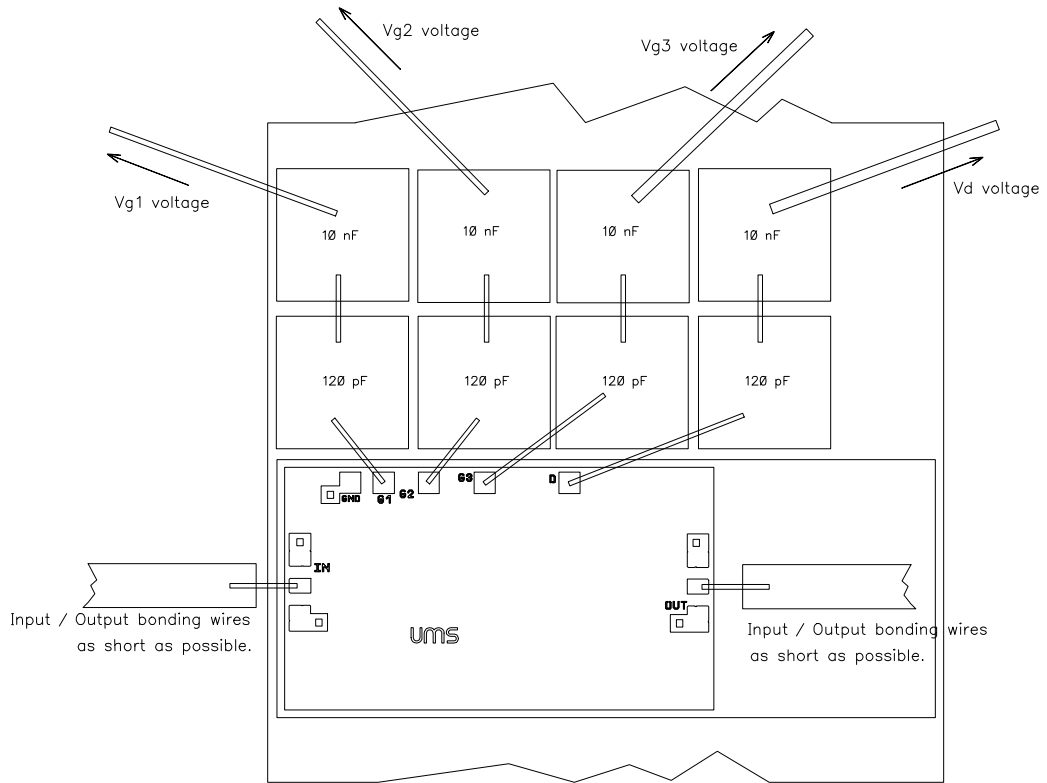

Note : Supply feed should be capacitively bypassed. 25µm diameter gold wire is to be preferred.

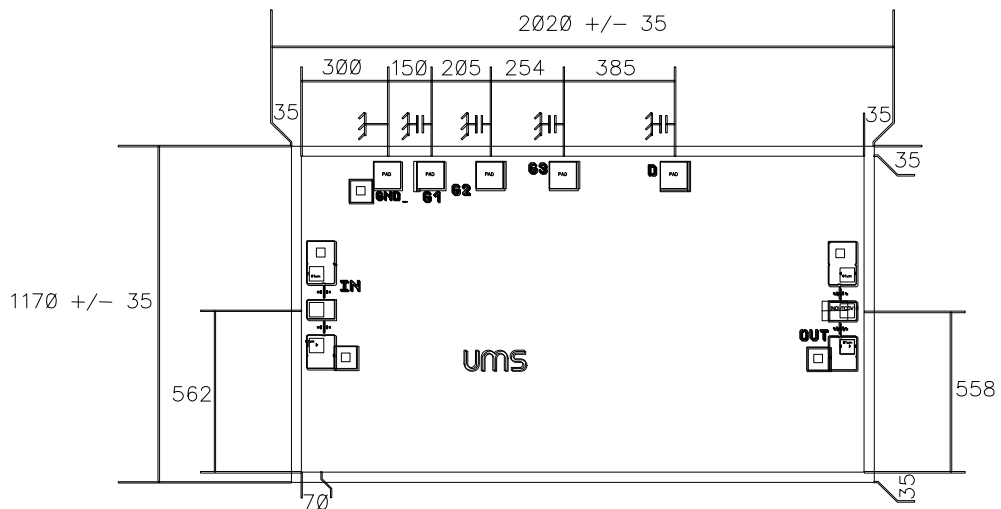

**Bonding pad positions.**  
( Chip thickness : 100µm. All dimensions are in micrometers )

*preliminary*

## Ordering Information

Chip form : MUX-PO9824-99F/00

Information furnished is believed to be accurate and reliable. However **United Monolithic Semiconductors S.A.S.** assumes no responsibility for the consequences of use of such information nor for any infringement of patents or other rights of third parties which may result from its use. No license is granted by implication or otherwise under any patent or patent rights of **United Monolithic Semiconductors S.A.S.**. Specifications mentioned in this publication are subject to change without notice. This publication supersedes and replaces all information previously supplied. **United Monolithic Semiconductors S.A.S.** products are not authorised for use as critical components in life support devices or systems without express written approval from **United Monolithic Semiconductors S.A.S.**

