

Cree® XLamp® MX-6S LEDs



PRODUCT DESCRIPTION

The Cree XLamp® MX-6S LED provides the proven lighting-class performance and reliability of Cree XLamp LEDs in a high-voltage, PLCC configuration. All members of the MX family of LEDs have wide viewing angle, uniform light output without secondary optics, unlimited floor life, and electrically neutral thermal path.

The XLamp MX-6S LED brings high performance and quality of light to a range of lighting applications that require near-line-voltage configuration, including LED light bulbs, fluorescent retrofits and retail-display lighting.

FEATURES

- Available in white (2600 K to 8300 K CCT)
- Wide viewing angle: 120°
- 20 VDC nominal with voltage binning available
- Electrically neutral thermal path
- Qualification at maximum drive current
- RoHS and REACH compliant
- UL® recognized component (E349212)

TABLE OF CONTENTS

Characteristics	2
Flux Characteristics	3
Relative Spectral Power Distribution	4
Relative Flux vs. Junction Temperature	4
Electrical Characteristics	5
Relative Flux vs. Current	5
Typical Spatial Distribution.....	6
Thermal Design.....	6
Reflow Soldering Characteristics.....	7
Notes	8
Mechanical Dimensions	10
Tape and Reel.....	11
Packaging.....	12



CHARACTERISTICS

Characteristics	Unit	Minimum	Typical	Maximum
Thermal resistance, junction to solder point	°C/W		5	
Viewing angle (FWHM)	degrees		120	
Temperature coefficient of voltage	mV/°C		-20	
ESD withstand voltage (HBM per Mil-Std-883D)	V			8000
DC forward current	mA			175
Forward voltage (@ 60 mA)	V		20.0	22.0
LED junction temperature	°C			150

FLUX CHARACTERISTICS ($T_j = 25\text{ }^\circ\text{C}$)

The following table provides several base order codes for XLamp MX-6S LEDs. It is important to note that the base order codes listed here are a subset of the total available order codes for the product family. For more order codes, as well as a complete description of the order-code nomenclature, please consult the XLamp MX LED Family Binning and Labeling document.

Color	CCT Range		Minimum Luminous Flux (lm) @ 60 mA		Order Code
	Minimum	Maximum	Group	Flux (lm)	
Cool White	5000 K	8300 K	R4	130	MX6SWT-A1-0000-000G51
			R3	122	MX6SWT-A1-0000-000F51
			R3	122	MX6SWT-A1-0000-000FE3
			R2	114	MX6SWT-A1-0000-000EE3
80-CRI White	5000 K	8300 K	R3	122	MX6SWT-H1-0000-000F51
			R2	114	MX6SWT-H1-0000-000E51
			R3	122	MX6SWT-H1-0000-000FE3
			R2	114	MX6SWT-H1-0000-000EE3
	2600 K	4300 K	R2	114	MX6SWT-H1-0000-000EE5
			Q5	107	MX6SWT-H1-0000-000DE5
			Q5	107	MX6SWT-H1-0000-000DE7
			Q4	100	MX6SWT-H1-0000-000CE7
Warm White	3700 K	4300 K	R2	114	MX6SWT-A1-0000-000EE5
			Q5	107	MX6SWT-A1-0000-000DE5
	2600 K	3700 K	Q5	107	MX6SWT-A1-0000-000DE7
			Q4	100	MX6SWT-A1-0000-000CE7

Notes:

- Cree maintains a tolerance of $\pm 7\%$ on flux and power measurements, ± 0.005 on chromaticity (CCx, CCy) measurements and ± 2 on CRI measurements. See the Measurements section (page 8).
- Typical CRI for Cool White (4300 K – 8300 K CCT) is 75.
- Typical CRI for Warm White (2600 K – 4000 K CCT) is 80.
- Minimum CRI for 80-CRI White is 80.

RELATIVE SPECTRAL POWER DISTRIBUTION

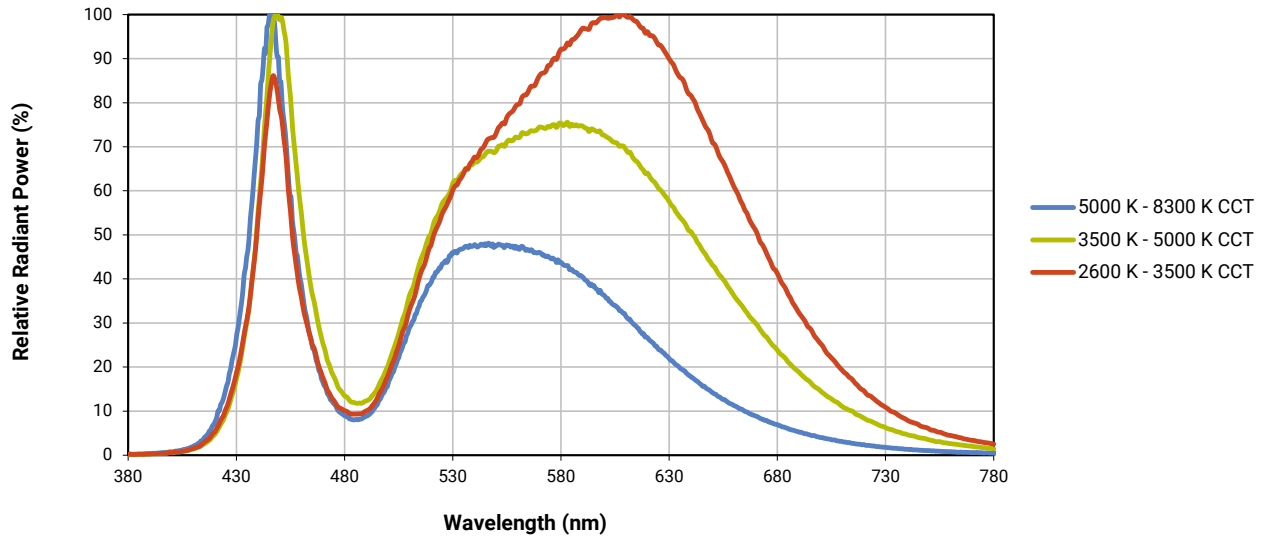

RELATIVE FLUX VS. JUNCTION TEMPERATURE ($I_F = 60 \text{ mA}$)

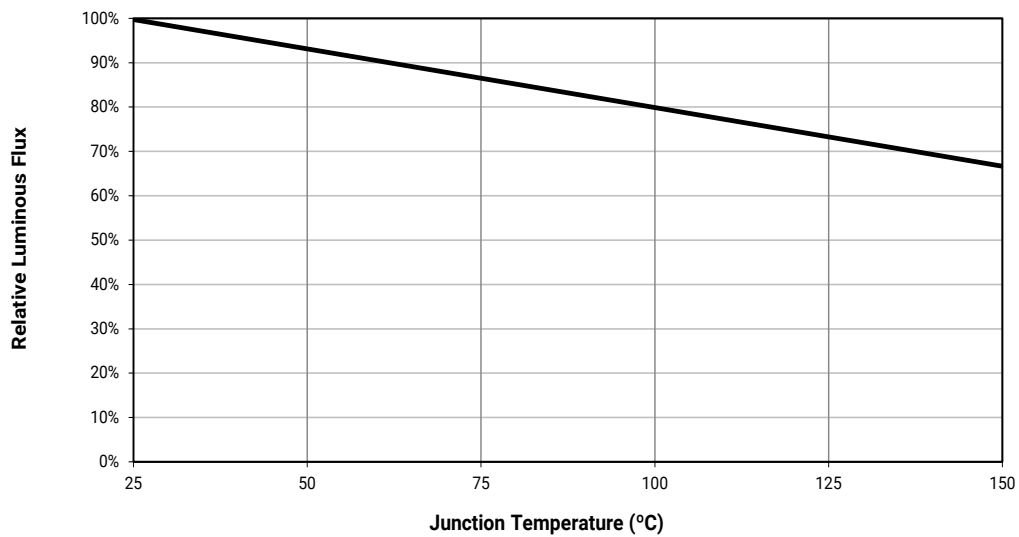

ELECTRICAL CHARACTERISTICS ($T_j = 25\text{ }^\circ\text{C}$)



RELATIVE FLUX VS. CURRENT ($T_j = 25\text{ }^\circ\text{C}$)



TYPICAL SPATIAL DISTRIBUTION



THERMAL DESIGN

The maximum forward current is determined by the thermal resistance between the LED junction and ambient. It is crucial for the end product to be designed in a manner that minimizes the thermal resistance from the solder point to ambient in order to optimize lamp life and optical characteristics.

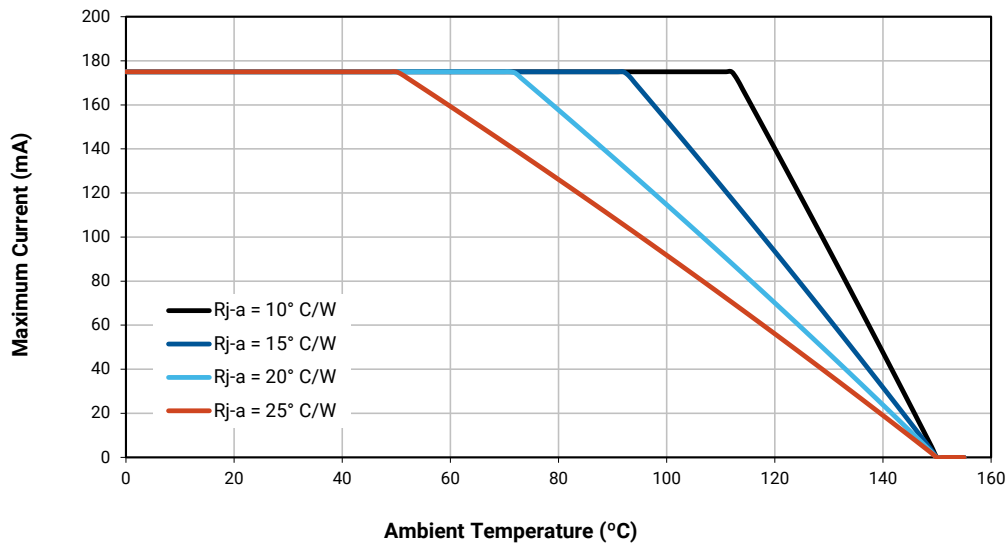

REFLOW SOLDERING CHARACTERISTICS

In testing, Cree has found XLamp MX-6S LEDs to be compatible with JEDEC J-STD-020C, using the parameters listed below. As a general guideline, Cree recommends that users follow the recommended soldering profile provided by the manufacturer of the solder paste used, and therefore it is the lamp or luminaire manufacturer’s responsibility to determine applicable soldering requirements.

Note that this general guideline may not apply to all PCB designs and configurations of reflow soldering equipment.

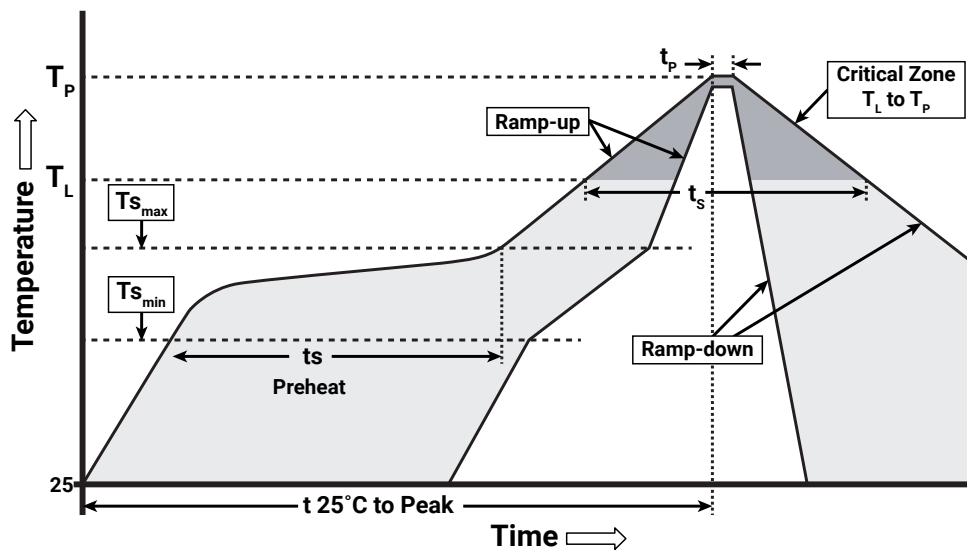

IPC/JEDEC J-STD-020C

Profile Feature	Lead-Free Solder
Average Ramp-Up Rate ($T_{s_{max}}$ to T_P)	1.2 °C/second
Preheat: Temperature Min ($T_{s_{min}}$)	120 °C
Preheat: Temperature Max ($T_{s_{max}}$)	170 °C
Preheat: Time ($t_{s_{min}}$ to $t_{s_{max}}$)	65-150 seconds
Time Maintained Above: Temperature (T_L)	217 °C
Time Maintained Above: Time (t_L)	45-90 seconds
Peak/Classification Temperature (T_P)	235 - 245 °C
Time Within 5 °C of Actual Peak Temperature (t_p)	20-40 seconds
Ramp-Down Rate	1 - 6 °C/second
Time 25 °C to Peak Temperature	4 minutes max.

Note: All temperatures refer to the topside of the package, measured on the package body surface.

NOTES

Measurements

The luminous flux, radiant power, chromaticity, forward voltage and CRI measurements in this document are binning specifications only and solely represent product measurements as of the date of shipment. These measurements will change over time based on a number of factors that are not within Cree's control and are not intended or provided as operational specifications for the products. Calculated values are provided for informational purposes only and are not intended or provided as specifications.

Pre-Release Qualification Testing

Please read the [LED Reliability Overview](#) for details of the qualification process Cree applies to ensure long-term reliability for XLamp LEDs and details of Cree's pre-release qualification testing for XLamp LEDs.

Lumen Maintenance

Cree now uses standardized IES LM-80-08 and TM-21-11 methods for collecting long-term data and extrapolating LED lumen maintenance. For information on the specific LM-80 data sets available for this LED, refer to the public [LM-80 results document](#).

Please read the [Long-Term Lumen Maintenance application note](#) for more details on Cree's lumen maintenance testing and forecasting. Please read the [Thermal Management application note](#) for details on how thermal design, ambient temperature and drive current affect the LED junction temperature.

Moisture Sensitivity

Cree recommends keeping XLamp MX-6S LEDs in the provided, resealable moisture-barrier packaging (MBP) until immediately prior to soldering. Unopened MBPs that contain XLamp LEDs do not need special storage for moisture sensitivity.

Once the MBP is opened, XLamp MX-6S LEDs should be handled and stored as MSL 2a per JEDEC J-STD-033, meaning they have limited exposure time before damage to the LED may occur during the soldering operation. The table on the right specifies the maximum exposure time in days depending on temperature and humidity conditions. LEDs with exposure time longer than the specified maximums must be baked according to the baking conditions listed below.

Temp.	Maximum Percent Relative Humidity						
	30%	40%	50%	60%	70%	80%	90%
35 °C	-	-	-	17	1	.5	.5
30 °C	-	-	-	28	1	1	1
25 °C	-	-	-	-	2	1	1
20 °C	-	-	-	-	2	1	1

Baking Conditions

It is not necessary to bake all XLamp MX-6S LEDs. Only the LEDs that meet all of the following criteria must be baked:

1. LEDs that have been removed from the original MBP.
2. LEDs that have been exposed to a humid environment longer than listed in the Moisture Sensitivity section above.
3. LEDs that have not been soldered.

LEDs should be baked at 70 °C for 24 hours. LEDs may be baked on the original reels. Remove LEDs from the MBP before baking. Do not bake parts at temperatures higher than 70 °C. This baking operation resets the exposure time as defined in the Moisture Sensitivity section above.

NOTES - CONTINUED

Storage Conditions

XLamp MX-6S LEDs that have been removed from the original MBP but not soldered should be stored in one of the following ways:

- Store the parts in a rigid metal container with a tight-fitting lid. Verify that the storage temperature is <30 °C, and place fresh desiccant and an RH indicator in the container to verify that the RH is no greater than 60%.
- Store the parts in a dry, nitrogen-purged cabinet or container that actively maintains the temperature at <30° and the RH at no greater than 60%.
- For short-term store only: LEDs can be resealed in the original MBP soon after opening. Fresh desiccant may be needed. Use the included humidity indicator card to verify <60% RH.

If an environment of <60% RH is not available for storage, XLamp MX-6S LEDs should be baked (described above) before reflow soldering.

RoHS Compliance

The levels of RoHS restricted materials in this product are below the maximum concentration values (also referred to as the threshold limits) permitted for such substances, or are used in an exempted application, in accordance with EU Directive 2011/65/EC (RoHS2), as implemented January 2, 2013. RoHS Declarations for this product can be obtained from your Cree representative or from the [Product Ecology](#) section of the Cree website.

REACH Compliance

REACH substances of very high concern (SVHCs) information is available for this product. Since the European Chemical Agency (ECHA) has published notice of their intent to frequently revise the SVHC listing for the foreseeable future, please contact a Cree representative to insure you get the most up-to-date REACH SVHC Declaration. REACH banned substance information (REACH Article 67) is also available upon request.

UL® Recognized Component

This product meets the requirements to be considered a UL Recognized Component with Level 4 enclosure consideration. The LED package or a portion thereof has been investigated as a fire and electrical enclosure per ANSI/UL 8750.

Vision Advisory

WARNING: Do not look at an exposed lamp in operation. Eye injury can result. See LED For more information about LEDs and eye safety, refer to the [LED Eye Safety application note](#).

MECHANICAL DIMENSIONS

All measurements are $\pm .13$ mm unless otherwise indicated.

Top View



Top View



Bottom View



Side View



Recommended FR4 Solder Pad



Recommended MCPCB Solder Pad



Alternative Solder Pad

TAPE AND REEL

All Cree carrier tapes conform to EIA-481D, Automated Component Handling Systems Standard.

Except as noted, all dimensions in mm.

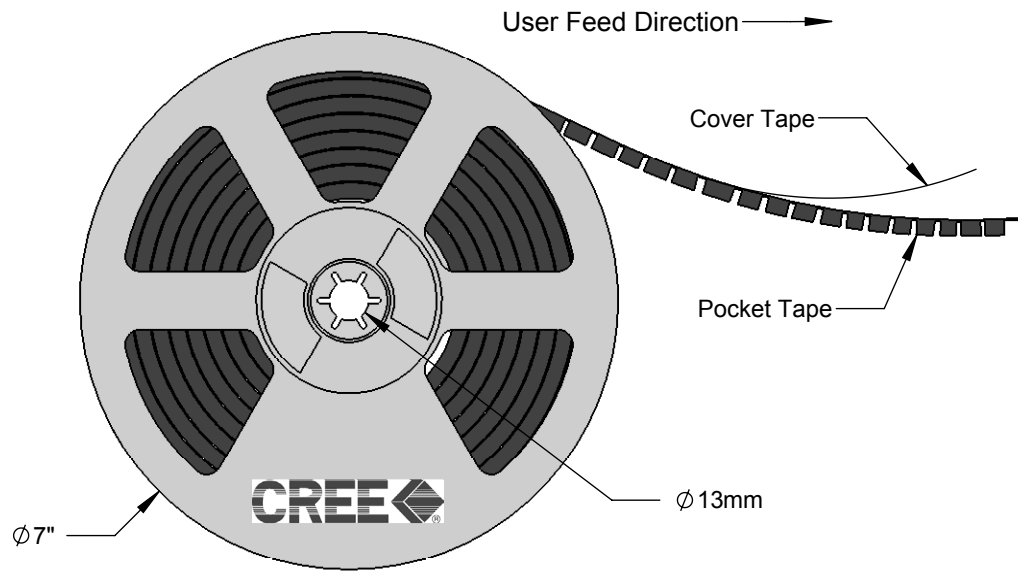

PACKAGING

Unpackaged Reel



Label with Cree Bin Code,
Quantity, Reel ID

Packaged Reel

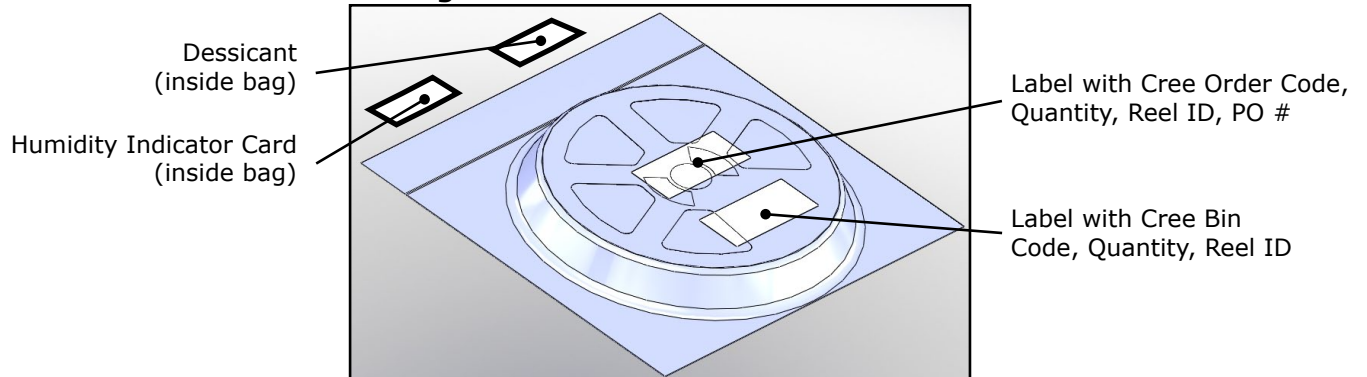

Dessicant
(inside bag)

Humidity Indicator Card
(inside bag)

Label with Cree Order Code,
Quantity, Reel ID, PO #

Label with Cree Bin
Code, Quantity, Reel ID

Boxed Reel

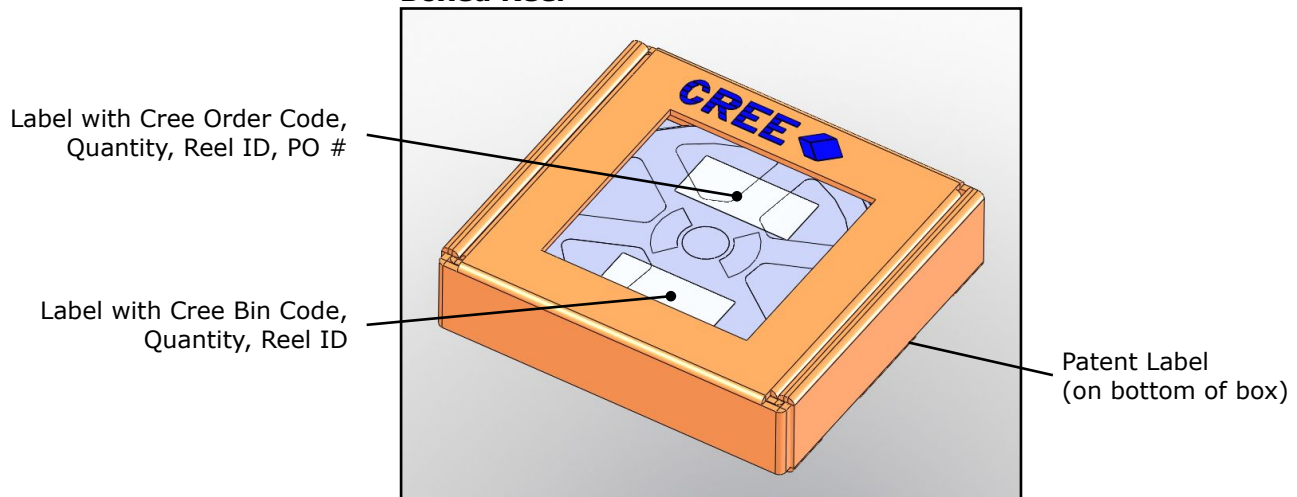

Label with Cree Order Code,
Quantity, Reel ID, PO #

Label with Cree Bin Code,
Quantity, Reel ID

Patent Label
(on bottom of box)

Cree, Inc.:

[MX6SWT-A1-0000-0009A9](#) [MX6SWT-A1-0000-0009AA](#) [MX6SWT-A1-0000-0009B8](#) [MX6SWT-A1-0000-0009B9](#)
[MX6SWT-A1-0000-0009E8](#) [MX6SWT-A1-0000-0009F8](#) [MX6SWT-A1-0000-000AA7](#) [MX6SWT-A1-0000-000AA8](#)
[MX6SWT-A1-0000-000AA9](#) [MX6SWT-A1-0000-000AAA](#) [MX6SWT-A1-0000-000AB6](#) [MX6SWT-A1-0000-000AB7](#)
[MX6SWT-A1-0000-000AB8](#) [MX6SWT-A1-0000-000AB9](#) [MX6SWT-A1-0000-000AE7](#) [MX6SWT-A1-0000-000AF7](#)
[MX6SWT-A1-0000-000AF8](#) [MX6SWT-A1-0000-000BA3](#) [MX6SWT-A1-0000-000BA4](#) [MX6SWT-A1-0000-000BA5](#)
[MX6SWT-A1-0000-000BA6](#) [MX6SWT-A1-0000-000BA7](#) [MX6SWT-A1-0000-000BA8](#) [MX6SWT-A1-0000-000BA9](#)
[MX6SWT-A1-0000-000BAA](#) [MX6SWT-A1-0000-000BB2](#) [MX6SWT-A1-0000-000BB3](#) [MX6SWT-A1-0000-000BB4](#)
[MX6SWT-A1-0000-000BB5](#) [MX6SWT-A1-0000-000BB6](#) [MX6SWT-A1-0000-000BB7](#) [MX6SWT-A1-0000-000BB8](#)
[MX6SWT-A1-0000-000BB9](#) [MX6SWT-A1-0000-000BE5](#) [MX6SWT-A1-0000-000BE6](#) [MX6SWT-A1-0000-000BF5](#)
[MX6SWT-A1-0000-000BF6](#) [MX6SWT-A1-0000-000BF7](#) [MX6SWT-A1-0000-000BF8](#) [MX6SWT-A1-0000-000CA1](#)
[MX6SWT-A1-0000-000CA2](#) [MX6SWT-A1-0000-000CA3](#) [MX6SWT-A1-0000-000CA4](#) [MX6SWT-A1-0000-000CA5](#)
[MX6SWT-A1-0000-000CA6](#) [MX6SWT-A1-0000-000CA7](#) [MX6SWT-A1-0000-000CA8](#) [MX6SWT-A1-0000-000CA9](#)
[MX6SWT-A1-0000-000CAA](#) [MX6SWT-A1-0000-000CB1](#) [MX6SWT-A1-0000-000CB2](#) [MX6SWT-A1-0000-000CB3](#)
[MX6SWT-A1-0000-000CB4](#) [MX6SWT-A1-0000-000CB5](#) [MX6SWT-A1-0000-000CB6](#) [MX6SWT-A1-0000-000CB7](#)
[MX6SWT-A1-0000-000CB8](#) [MX6SWT-A1-0000-000CB9](#) [MX6SWT-A1-0000-000CDZ](#) [MX6SWT-A1-0000-000CE3](#)
[MX6SWT-A1-0000-000CE4](#) [MX6SWT-A1-0000-000CE6](#) [MX6SWT-A1-0000-000CF4](#) [MX6SWT-A1-0000-000CF5](#)
[MX6SWT-A1-0000-000CF6](#) [MX6SWT-A1-0000-000CF7](#) [MX6SWT-A1-0000-000CF8](#) [MX6SWT-A1-0000-000D50](#)
[MX6SWT-A1-0000-000D51](#) [MX6SWT-A1-0000-000D53](#) [MX6SWT-A1-0000-000DA1](#) [MX6SWT-A1-0000-000DA2](#)
[MX6SWT-A1-0000-000DA3](#) [MX6SWT-A1-0000-000DA4](#) [MX6SWT-A1-0000-000DA5](#) [MX6SWT-A1-0000-000DA6](#)
[MX6SWT-A1-0000-000DA7](#) [MX6SWT-A1-0000-000DA8](#) [MX6SWT-A1-0000-000DB1](#) [MX6SWT-A1-0000-000DB2](#)
[MX6SWT-A1-0000-000DB3](#) [MX6SWT-A1-0000-000DB4](#) [MX6SWT-A1-0000-000DB5](#) [MX6SWT-A1-0000-000DB6](#)
[MX6SWT-A1-0000-000DB7](#) [MX6SWT-A1-0000-000DDZ](#) [MX6SWT-A1-0000-000DE4](#) [MX6SWT-A1-0000-000DE6](#)
[MX6SWT-A1-0000-000DE7](#) [MX6SWT-A1-0000-000DF5](#) [MX6SWT-A1-0000-000DF6](#) [MX6SWT-A1-0000-000DF7](#)
[MX6SWT-A1-0000-000E50](#) [MX6SWT-A1-0000-000E53](#) [MX6SWT-A1-0000-000EA1](#) [MX6SWT-A1-0000-000EA2](#)
[MX6SWT-A1-0000-000EA3](#) [MX6SWT-A1-0000-000EA4](#) [MX6SWT-A1-0000-000EB1](#) [MX6SWT-A1-0000-000EB2](#)