

NCP5663, NCV5663

Low Output Voltage, Ultra-Fast 3.0 A Low Dropout Linear Regulator with Enable

The NCP5663/NCV5663 is a high performance, low dropout linear regulator designed for high power applications that require up to 3.0 A current. It is offered in both fixed and adjustable output versions. With output voltages as low as 0.9 V and ultra-fast response times for load transients, the NCP5663/NCV5663 also provides additional features such as Enable and Error Flag (for the fixed output version), increasing the utility of this device. A thermally robust, 5 pin D²PAK, combined with an architecture that offers low ground current (independent of load), provides for a superior high-current LDO solution.

Features

- Ultra-Fast Transient Response (Settling Time: 1–3 μ s)
- Low Noise Without Bypass Capacitor (28 μ V_{rms})
- Low Ground Current Independent of Load (3.0 mA Maximum)
- Fixed/Adjustable Output Voltage Versions
- Enable Function
- Error Flag (Fixed Output Version)
- Current Limit Protection
- Thermal Protection
- 0.9 V Reference Voltage for Ultra-Low Output Operation
- Power Supply Rejection Ratio > 65 dB
- NCV Prefix for Automotive and Other Applications Requiring Unique Site and Control Change Requirements; AEC-Q100 Qualified and PPAP Capable
- This is a Pb-Free Device

Applications

- Servers
- ASIC Power Supplies
- Post Regulation for Power Supplies
- Constant Current Source
- Networking Equipment
- Gaming and STB Modules



ON Semiconductor®

<http://onsemi.com>

MARKING DIAGRAM

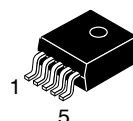

D²PAK
CASE 936A



Tab = Ground

- Pin
1. Enable
 2. V_{in}
 3. Ground
 4. V_{out}
 5. Adj (adjustable output)
 5. Error Flag (fixed output)

x = P or V

y = A for Adjustable Version
B for Fixed 1.5 V Version
C for Fixed 1.8 V Version

A = Assembly Location

W = Wafer Lot

Y = Year

WW = Work Week

G = Pb-Free

ORDERING INFORMATION

See detailed ordering and shipping information in the package dimensions section on page 11 of this data sheet.

NCP5663, NCV5663

PIN FUNCTION DESCRIPTION

| Pin Adj/Fixed | Pin Name | Description |
|---------------|-------------------------------|---|
| 1 | Enable | This pin allows for on/off control of the regulator. To disable the device, connect to Ground. If this function is not in use, connect to V_{in} . |
| 2 | V_{in} | Positive Power Supply Input Voltage |
| 3 | Ground | Power Supply Ground |
| 4 | V_{out} | Regulated Output Voltage |
| 5 | Adj (Adjustable Version) | This pin is connected to the resistor divider network and programs the output voltage. |
| 5 | Error Flag (Fixed Version) | An Error Flag is triggered when the output voltage is out of regulation excluding transient signals that may occur. Requires a pullup resistor $\approx 100\text{ k}\Omega$. |

ABSOLUTE MAXIMUM RATINGS

| Rating | Symbol | Value | Unit |
|--|------------------------------------|------------------------|-----------------------------|
| Input Voltage (Note 1) | V_{in} | 18 | V |
| Output Pin Voltage | V_{out} | -0.3 to $V_{in} + 0.3$ | V |
| Adjust Pin Voltage | V_{adj} | -0.3 to $V_{in} + 0.3$ | V |
| Enable Pin Voltage | V_{en} | -0.3 to $V_{in} + 0.3$ | V |
| Error Flag Voltage | V_{ef} | -0.3 to $V_{in} + 0.3$ | V |
| Error Flag Current | I_{ef} | 3.0 | mA |
| Thermal Characteristics (Note 1) Thermal Resistance Junction-to-Air (Note 2) Thermal Resistance Junction-to-Case | $R_{\theta JA}$ $R_{\theta JC}$ | 45 5.0 | $^{\circ}\text{C}/\text{W}$ |
| Operating Junction Temperature Range | T_J | -40 to +150 | $^{\circ}\text{C}$ |
| Storage Temperature Range | T_{stg} | -55 to +150 | $^{\circ}\text{C}$ |

Stresses exceeding Maximum Ratings may damage the device. Maximum Ratings are stress ratings only. Functional operation above the Recommended Operating Conditions is not implied. Extended exposure to stresses above the Recommended Operating Conditions may affect device reliability.

NOTE: This device series contains ESD protection and exceeds the following tests:

Human Body Model (HBM) JESD 22-A114-B

Machine Model (MM) JESD 22-A115-A.

1. Refer to Electrical Characteristics table and Application Information section for Safe Operating Area.
2. As measured using a copper heat spreading area of 625 mm², 1 oz. copper thickness.

NCP5663, NCV5663

ELECTRICAL CHARACTERISTICS

($V_{in} - V_{out} = 1.5\text{ V}$, for typical values $T_J = 25^\circ\text{C}$, for min/max values $T_J = -40^\circ\text{C}$ to 85°C (125°C for NCV versions), $C_{in} = C_{out} = 150\ \mu\text{F}$ unless otherwise noted.)

| Characteristic | Symbol | Min | Typ | Max | Unit |
|--|----------------------------|---------------------|---------------|---------------------|----------------------------|
| ADJUSTABLE OUTPUT VERSION | | | | | |
| Input Voltage | V_{in} | 2.0 | – | 9.0 | V |
| Output Noise Voltage | V_n | – | 28 | – | μV_{rms} |
| Output Voltage Accuracy $T_J = 25^\circ\text{C}$ ($V_{in} = V_{out} + 1.5\text{ V}$ to 7.0 V , $I_{out} = 10\text{ mA}$ to 3.0 A) $T_J = -20$ to $+125^\circ\text{C}$ ($V_{in} = V_{out} + 1.5\text{ V}$ to 7.0 V , $I_{out} = 10\text{ mA}$ to 3.0 A) $T_J = -40$ to $+150^\circ\text{C}$ ($V_{in} = V_{out} + 1.5\text{ V}$ to 7.0 V , $I_{out} = 10\text{ mA}$ to 3.0 A) | V_{out} | -1% -1.5% -2% | – 0.9 – | +1% +1.5% +2% | V |
| Adjustable Pin Input Current | I_{adj} | – | 40 | – | nA |
| Line Regulation ($I_{out} = 10\text{ mA}$, $V_{out} + 1.5\text{ V} < V_{in} < 7.0\text{ V}$) | REG_{line} | – | 0.03 | – | % |
| Load Regulation ($10\text{ mA} < I_{out} < 3.0\text{ A}$) | REG_{load} | – | 0.03 | – | % |
| Dropout Voltage ($I_{out} = 3.0\text{ A}$) | V_{DO} | – | 1.0 | 1.3 | V |
| Peak Output Current Limit | I_{out} | 3.0 | – | – | A |
| Internal Current Limitation | I_{lim} | – | 4.5 | – | A |
| Ripple Rejection (120 Hz) | RR | – | 70 | – | dB |
| Ripple Rejection (1 kHz) | | – | 65 | – | |
| Thermal Shutdown (Guaranteed by Design) | T_{SHD} | – | 160 | – | $^\circ\text{C}$ |
| Ground Current $I_{out} = 3.0\text{ A}$ Disabled State | I_q I_{qds} | – – | 1.3 10 | 3.0 300 | mA μA |
| Enable Input Threshold Voltage Voltage Increasing, On state, Logic High Voltage Decreasing, Off state, Logic Low | V_{en} | 1.3 – | – – | – 0.3 | V |
| Enable Input Current Enable Pin Voltage = $0.3\text{ V}_{\text{max}}$ Enable Pin Voltage = $1.3\text{ V}_{\text{min}}$ | I_{en} | – – | 0.5 0.5 | – – | μA |

NCP5663, NCV5663

ELECTRICAL CHARACTERISTICS

($V_{in} - V_{out} = 1.5$ V, for typical values $T_J = 25^\circ\text{C}$, for min/max values $T_J = -40^\circ\text{C}$ to 85°C (125°C for NCV versions), $C_{in} = C_{out} = 150$ μF unless otherwise noted.)

| Characteristic | Symbol | Min | Typ | Max | Unit |
|---|----------------------------|---------------------|---------------------|---------------------|----------------------------|
| FIXED OUTPUT VOLTAGE | | | | | |
| Input Voltage | V_{in} | 2.0 | – | 9.0 | V |
| Output Noise Voltage ($V_{out} = 0.9$ V) | V_n | – | 28 | – | μV_{rms} |
| Output Voltage Accuracy (Note 3) $T_J = 25^\circ\text{C}$ ($V_{in} = V_{out} + 1.5$ V to 7.0 V, $I_{out} = 10$ mA to 3.0 A) $T_J = -20$ to $+125^\circ\text{C}$ ($V_{in} = V_{out} + 1.5$ V to 7.0 V, $I_{out} = 10$ mA to 3.0 A) $T_J = -40$ to $+150^\circ\text{C}$ ($V_{in} = V_{out} + 1.5$ V to 7.0 V, $I_{out} = 10$ mA to 3.0 A) | V_{out} | -1% -1.5% -2% | – V_{out} – | +1% +1.5% +2% | V |
| Line Regulation ($I_{out} = 10$ mA, $V_{out} + 1.5$ V < V_{in} < 7.0 V) | REG_{line} | – | 0.03 | – | % |
| Load Regulation (10 mA < I_{out} < 3.0 A) | REG_{load} | – | 0.2 | – | % |
| Dropout Voltage ($I_{out} = 3.0$ A) | V_{DO} | – | 1.0 | 1.3 | V |
| Peak Output Current Limit | I_{out} | 3.0 | – | – | A |
| Internal Current Limitation | I_{lim} | – | 4.5 | – | A |
| Ripple Rejection (120 Hz) | RR | – | 70 | – | dB |
| Ripple Rejection (1 kHz) | | – | 65 | – | |
| Thermal Shutdown (Guaranteed by Design) | T_{SHD} | – | 160 | – | $^\circ\text{C}$ |
| Ground Current $I_{out} = 3.0$ A Disabled State | I_q I_{qds} | – – | 1.3 30 | 3.0 300 | mA μA |
| Enable Input Threshold Voltage Voltage Increasing, On state, Logic High Voltage Decreasing, Off state, Logic Low | V_{en} | 1.3 – | – – | – 0.3 | V |
| Enable Input Current Enable Pin Voltage = $0.3 V_{\text{max}}$ Enable Pin Voltage = $1.3 V_{\text{min}}$ | I_{en} | – – | 0.5 0.5 | – – | μA |
| Error Flag (Fixed Output) | V_{cflt} | 91 | 94 | 97 | % of V_{out} |
| Error Flag Output Low Voltage Saturation ($I_{\text{ef}} = 1.0$ mA) | V_{cfd0} | – | 200 | – | mV |
| Error Flag Leakage | I_{efleak} | – | 1.0 | – | μA |
| Error Flag Blanking Time (Note 4) | T_{ef} | – | 50 | – | μs |

3. Refer to Ordering Information Table for available voltage options.
4. Can be disabled per customer request.

NCP5663, NCV5663

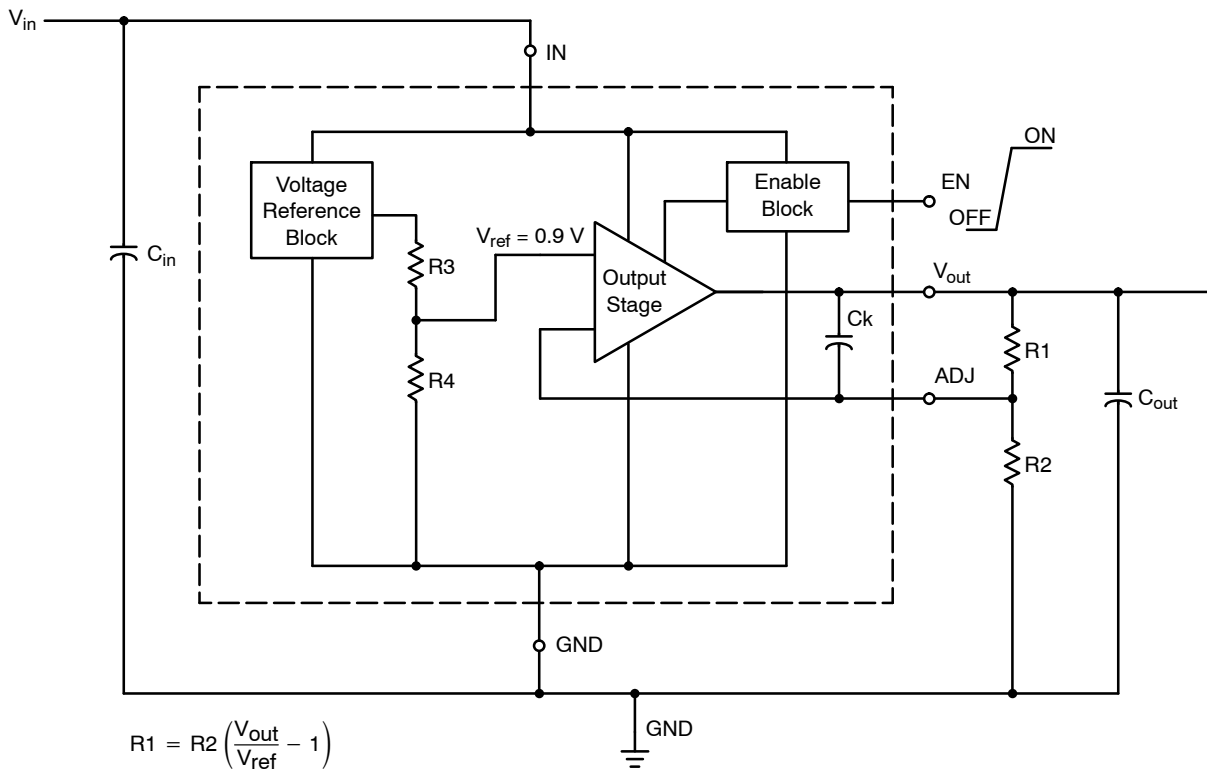

Figure 1. Typical Schematic, Adjustable Output Version

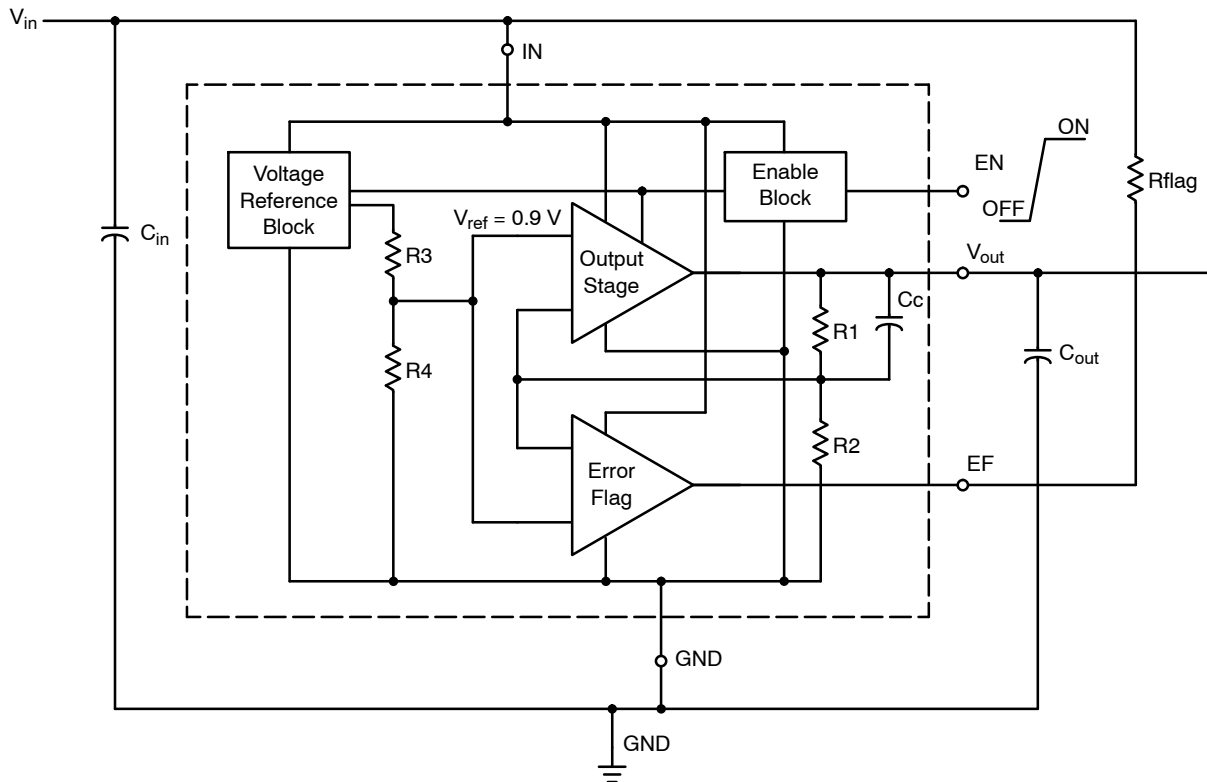

Figure 2. Typical Schematic, Fixed Output Version

NCP5663, NCV5663

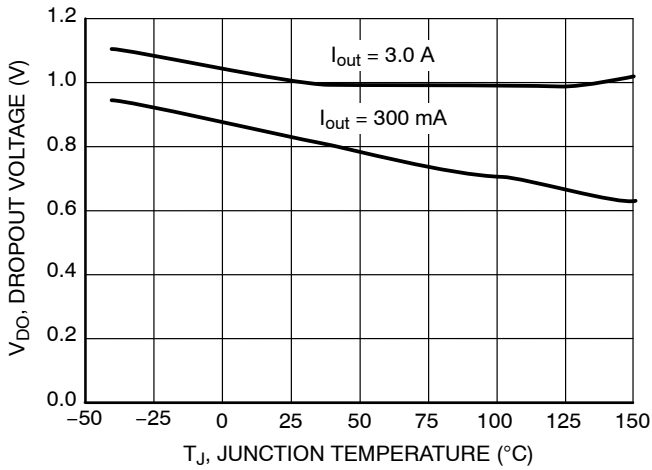

Figure 1. Dropout Voltage vs. Temperature

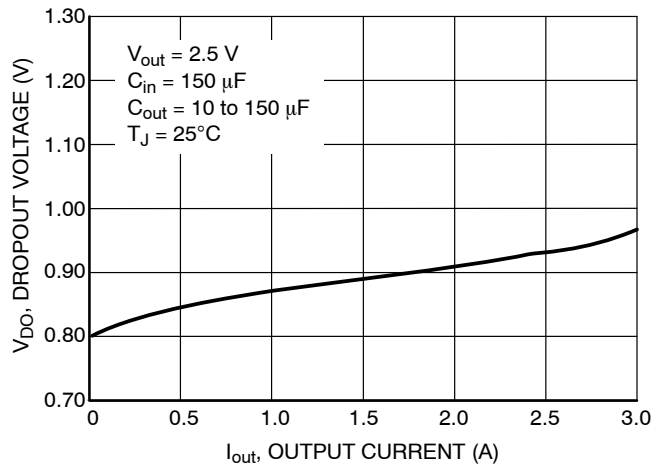

Figure 2. Dropout Voltage vs. Output Current

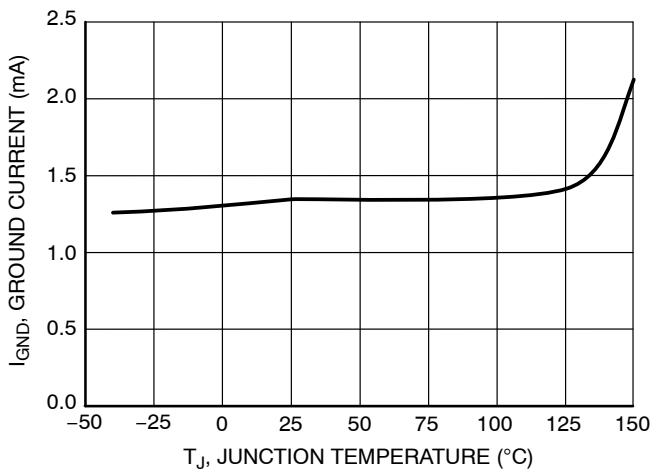

Figure 3. Ground Current vs. Temperature

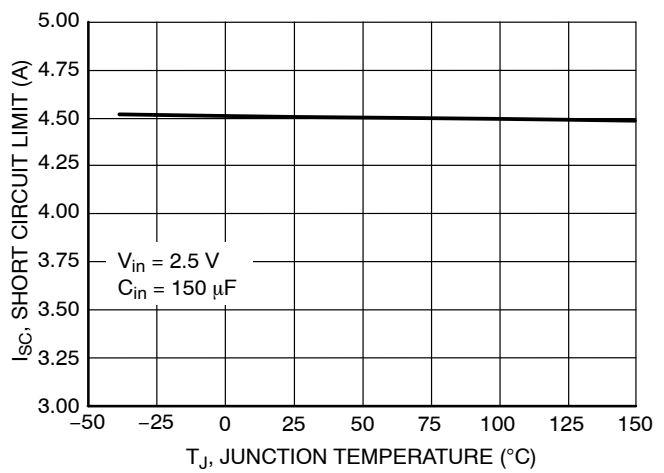

Figure 4. Short Circuit Current Limit vs. Temperature

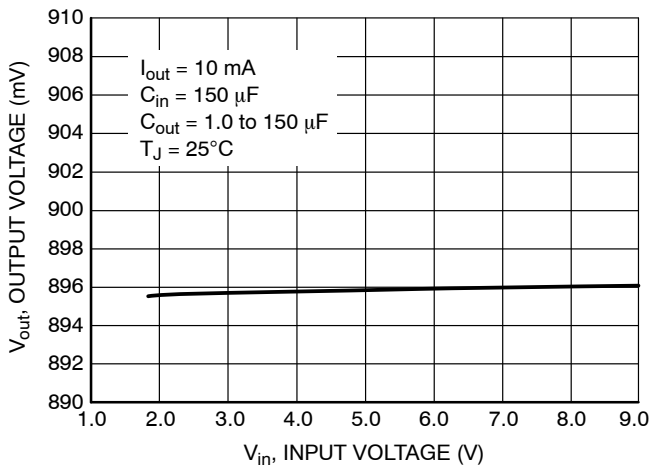

Figure 5. Output Voltage vs. Input Voltage

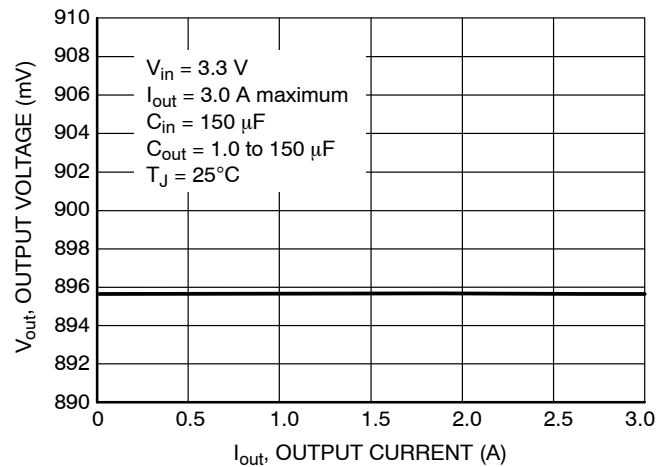

Figure 6. Output Voltage vs. Output Load Current

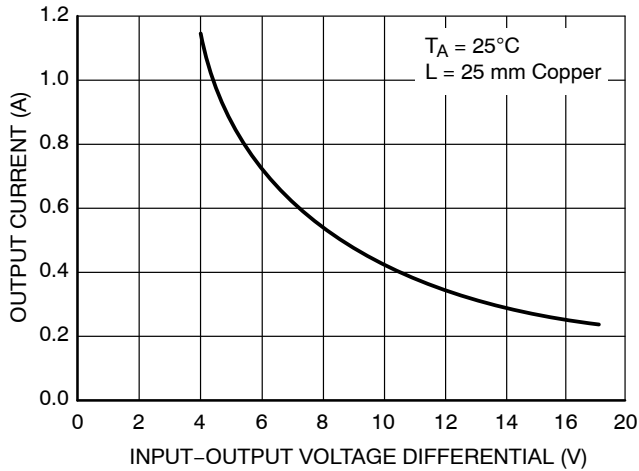

Figure 7. Output Current vs. Input-Output Voltage Differential

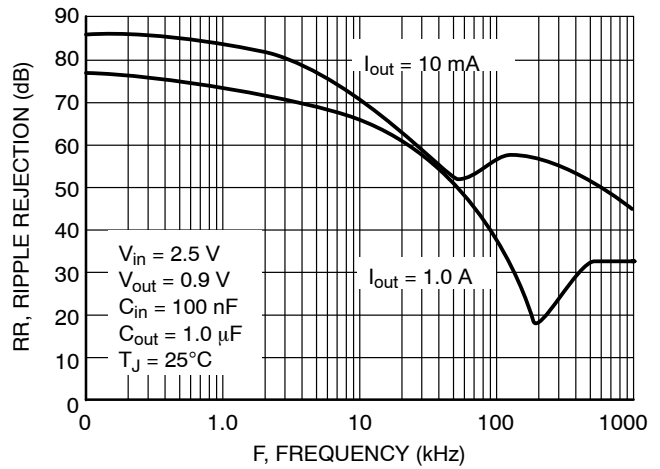

Figure 8. Ripple Rejection vs. Frequency

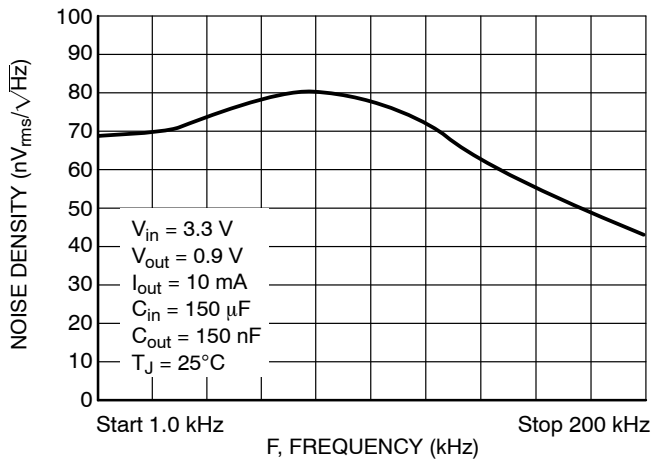

Figure 9. Noise Density vs. Frequency

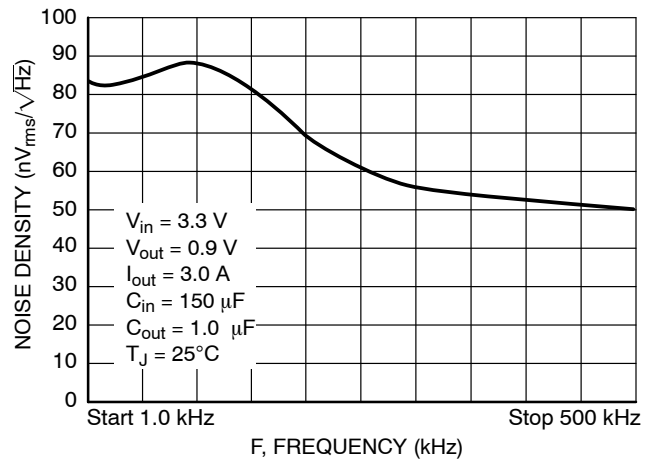

Figure 10. Noise Density vs. Frequency

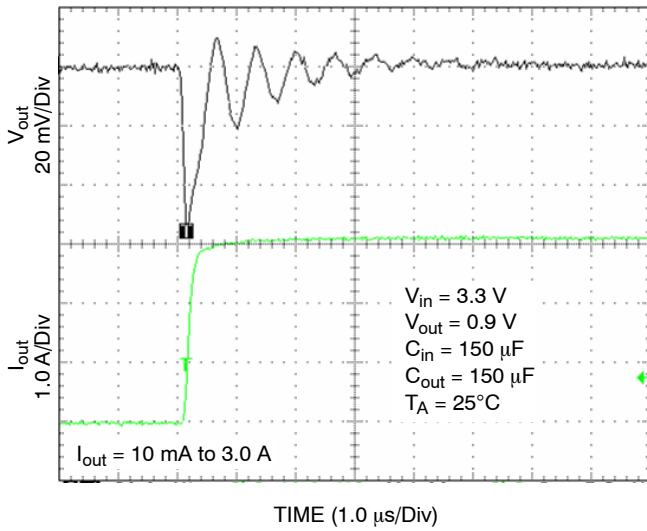

Figure 11. Load Transient Response

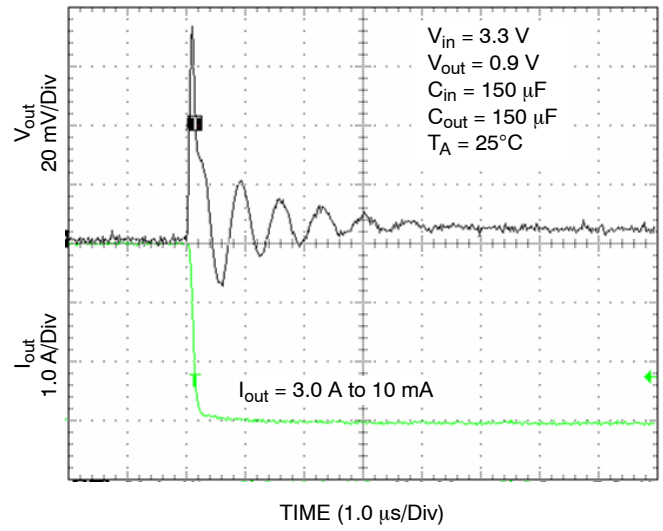

Figure 12. Load Transient Response

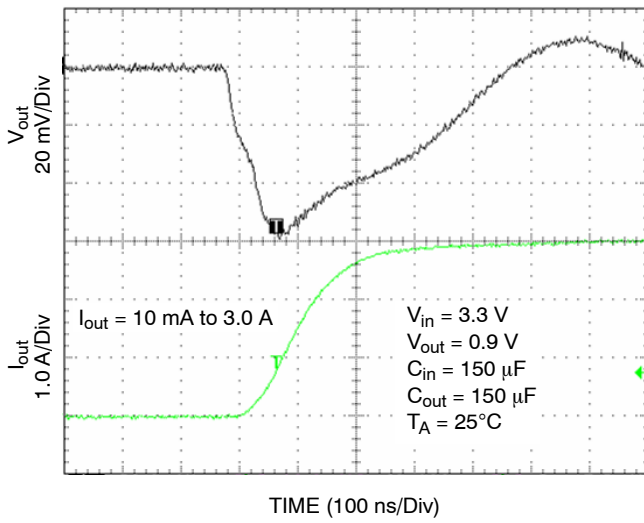

Figure 13. Load Transient Response

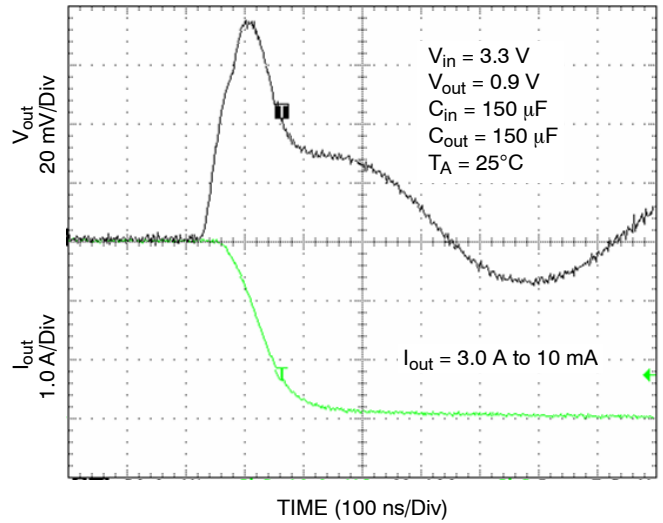

Figure 14. Load Transient Response

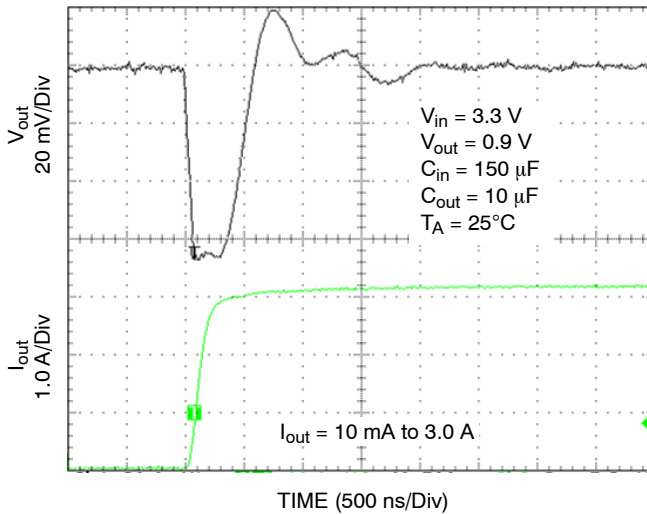

Figure 15. Load Transient Response

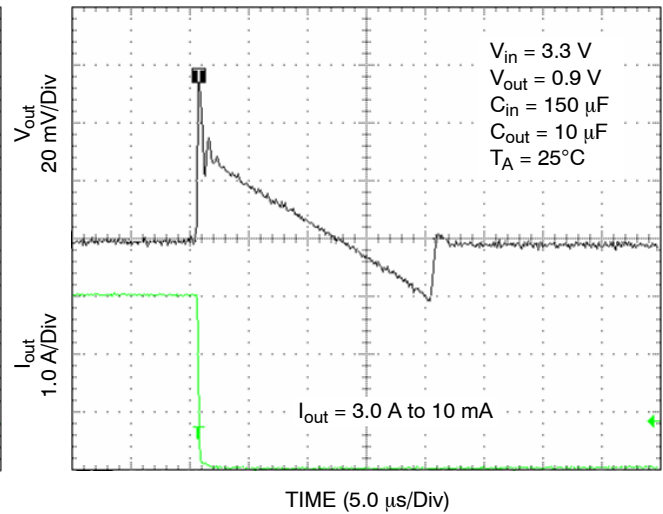

Figure 16. Load Transient Response

APPLICATION INFORMATION

The NCP5663/NCV5663 is a high performance low dropout 3.0 A linear regulator suitable for high power applications, featuring an ultra-fast response time and low noise without a bypass capacitor. It is offered in both fixed and adjustable output versions with voltages as low as 0.9 V. Additional features, such as Enable and Error Flag (fixed output version) increase the utility of the NCP5663/NCV5663. It is thermally robust and includes the safety features necessary during a fault condition, which provide for an attractive high current LDO solution for server, ASIC power supplies, networking equipment applications, and many others.

Input Capacitor

The recommended input capacitor value is a 150 µF OSCON with an Equivalent Series Resistance (ESR) of 50 mΩ. It is especially required if the power source is located more than a few inches from the NCP5663/NCV5663. This capacitor will reduce device sensitivity and enhance the output transient response time. The PCB layout is very important and in order to obtain the optimal solution, the Vin and GND traces should be sufficiently wide to minimize noise and unstable operation.

Output Capacitor

Proper output capacitor selection is required to maintain stability. The NCP5663/NCV5663 is stable for C_{out} as low as 10 µF (Figures 15 and 16) and guaranteed to be stable at an output capacitance of, C_{out} > 33 µF with an ESR between 50 mΩ and 300 mΩ over the output current range of 10 mA to 3.0 A. For PCB layout considerations, place the recommended ceramic capacitor close to the output pin and keep the leads short. This should help ensure ultra-fast transient response times.

Adjustable Output Operation

The application circuit for the adjustable output version is shown in Figure 1. The reference voltage is 0.9 V and the adjustable pin current is typically 40 nA. A resistor divider network, R1 and R2, is calculated using the following formula:

$$R1 = R2 \left(\frac{V_{out}}{V_{ref}} - 1 \right)$$

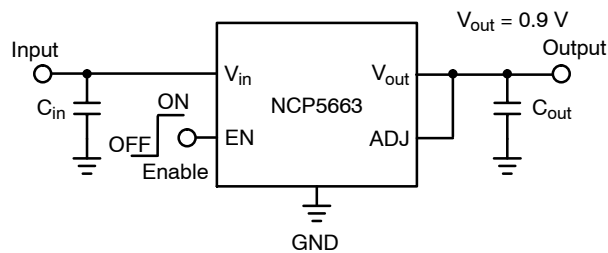

Figure 17. To achieve the minimum output voltage, ADJ to V_{out} has to be connected together

Current Limit Operation

As the peak output current increases beyond its limitation, the device is internally clamped to 4.5 A, thus causing the output voltage to decrease and go out of regulation. This allows the device never to exceed the maximum power dissipation.

Error Flag Operation

The Error Flag pin on the NCP5663/NCV5663 will produce a logic Low when it drops below the nominal output voltage. Refer to the electrical characteristics for the threshold values at which point the Error Flag goes Low. When the NCP5663/NCV5663 is above the nominal output voltage, the Error Flag will remain at logic High.

The external pullup resistor needs to be connected between V_{in} and the Error Flag pin. A resistor of approximately 100 kΩ is recommended to minimize the current consumption. No pullup resistor is required if the Error Flag output is not being used.

Thermal Consideration

This series contains an internal thermal limiting circuit that is designed to protect the regulator in the event that the maximum junction temperature is exceeded. This feature provides protection from a catastrophic device failure due to accidental overheating. It is not intended to be used as a substitute for proper heat sinking. The maximum device power dissipation can be calculated by:

$$P_D = \frac{T_{J(max)} - T_A}{R_{\theta JA}}$$

The bipolar process employed for this IC is fully characterized and rated for reliable 18 V V_{CCmax} operation. To avoid damaging the part or degrading its reliability, power dissipation transients should be limited to under 30 W for D²PAK. For open-circuit to short-circuit transient,

$$P_{DTransient} = V_{CCmax} * I_{SC}$$

NCP5663, NCV5663

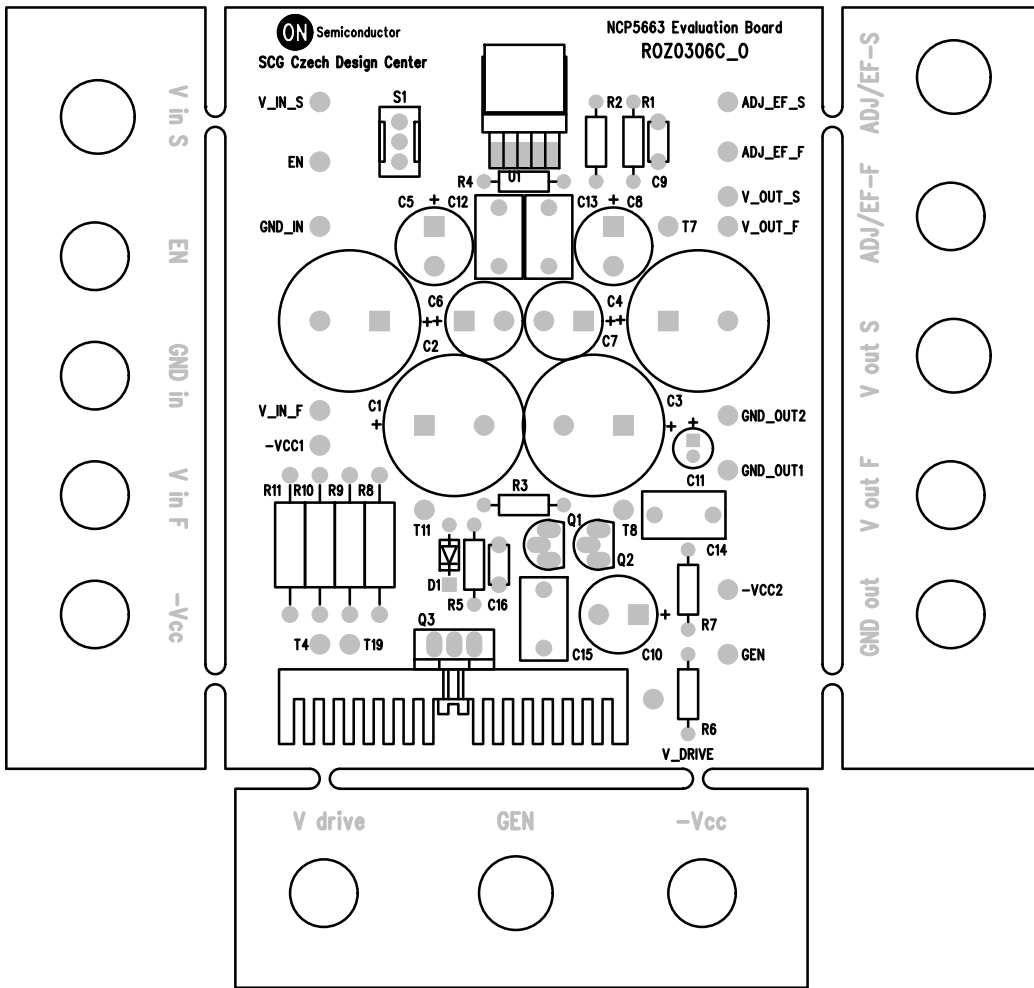

Figure 18. Test Board used for Evaluation

NCP5663, NCV5663

ORDERING INFORMATION

| Device | Nominal Output Voltage | Package | Shipping† |
|--------------------------|------------------------|---------------------------------|-----------------|
| NCP5663DSADJR4G | Adj | D ² PAK (Pb-Free) | 800 Tape & Reel |
| NCP5663DS15R4G (Note 5) | Fixed, 1.5 V | | 800 Tape & Reel |
| NCP5663DS18R4G (Note 5) | Fixed, 1.8 V | | 800 Tape & Reel |
| NCP5663DS18G (Note 5) | Fixed, 1.8 V | | 50 Units / Rail |
| NCV5663DSADJR4G* | Adj | | 800 Tape & Reel |
| NCV5663DS15R4G* (Note 5) | Fixed, 1.5 V | | 800 Tape & Reel |

5. Other fixed output voltages available at 0.9 V, 1.2 V, 2.5 V, 3.0 V, 3.3 V per request.

†For information on tape and reel specifications, including part orientation and tape sizes, please refer to our Tape and Reel Packaging Specifications Brochure, BRD8011/D.

*NCV Prefix for Automotive and Other Applications Requiring Unique Site and Control Change Requirements; AEC-Q100 Qualified and PPAP Capable

NCP5663, NCV5663

PACKAGE DIMENSIONS

D²PAK 5-LEAD CASE 936A-02 ISSUE C

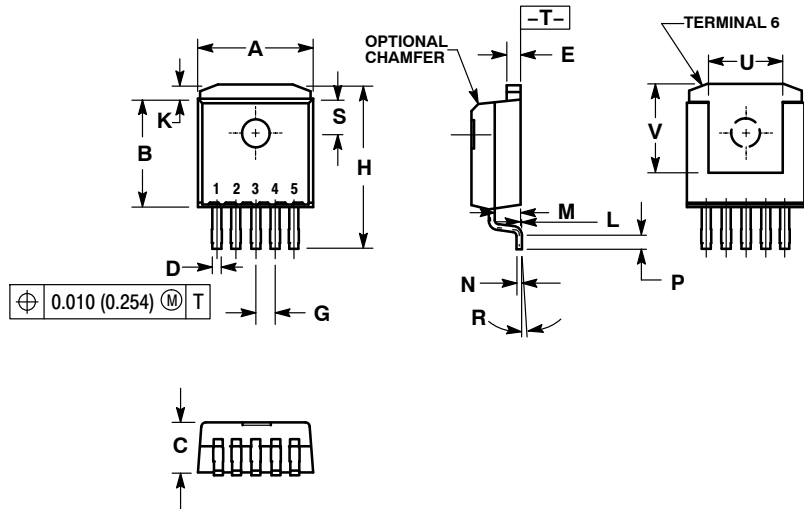

NOTES:

1. DIMENSIONING AND TOLERANCING PER ANSI Y14.5M, 1982.
2. CONTROLLING DIMENSION: INCH.
3. TAB CONTOUR OPTIONAL WITHIN DIMENSIONS A AND K.
4. DIMENSIONS U AND V ESTABLISH A MINIMUM MOUNTING SURFACE FOR TERMINAL 6.
5. DIMENSIONS A AND B DO NOT INCLUDE MOLD FLASH OR GATE PROTRUSIONS. MOLD FLASH AND GATE PROTRUSIONS NOT TO EXCEED 0.025 (0.635) MAXIMUM.

| DIM | INCHES | | MILLIMETERS | |
|-----|-----------|-------|-------------|--------|
| | MIN | MAX | MIN | MAX |
| A | 0.386 | 0.403 | 9.804 | 10.236 |
| B | 0.356 | 0.368 | 9.042 | 9.347 |
| C | 0.170 | 0.180 | 4.318 | 4.572 |
| D | 0.026 | 0.036 | 0.660 | 0.914 |
| E | 0.045 | 0.055 | 1.143 | 1.397 |
| G | 0.067 BSC | | 1.702 BSC | |
| H | 0.539 | 0.579 | 13.691 | 14.707 |
| K | 0.050 REF | | 1.270 REF | |
| L | 0.000 | 0.010 | 0.000 | 0.254 |
| M | 0.088 | 0.102 | 2.235 | 2.591 |
| N | 0.018 | 0.026 | 0.457 | 0.660 |
| P | 0.058 | 0.078 | 1.473 | 1.981 |
| R | 5° REF | | 5° REF | |
| S | 0.116 REF | | 2.946 REF | |
| U | 0.200 MIN | | 5.080 MIN | |
| V | 0.250 MIN | | 6.350 MIN | |

SOLDERING FOOTPRINT

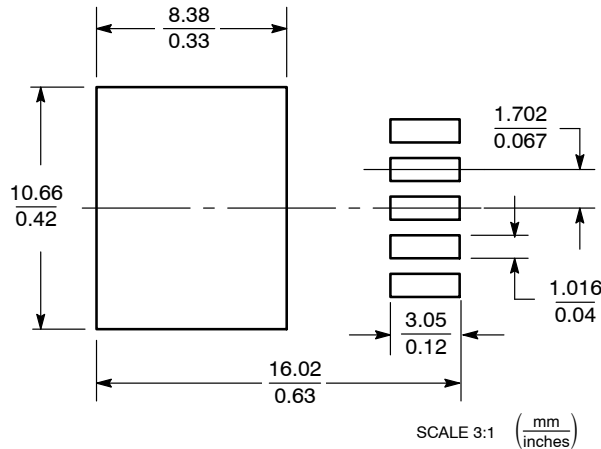

ON Semiconductor and **ON** are registered trademarks of Semiconductor Components Industries, LLC (SCILLC). SCILLC owns the rights to a number of patents, trademarks, copyrights, trade secrets, and other intellectual property. A listing of SCILLC's product/patent coverage may be accessed at www.onsemi.com/site/pdf/Patent-Marking.pdf. SCILLC reserves the right to make changes without further notice to any products herein. SCILLC makes no warranty, representation or guarantee regarding the suitability of its products for any particular purpose, nor does SCILLC assume any liability arising out of the application or use of any product or circuit, and specifically disclaims any and all liability, including without limitation special, consequential or incidental damages. "Typical" parameters which may be provided in SCILLC data sheets and/or specifications can and do vary in different applications and actual performance may vary over time. All operating parameters, including "Typicals" must be validated for each customer application by customer's technical experts. SCILLC does not convey any license under its patent rights nor the rights of others. SCILLC products are not designed, intended, or authorized for use as components in systems intended for surgical implant into the body, or other applications intended to support or sustain life, or for any other application in which the failure of the SCILLC product could create a situation where personal injury or death may occur. Should Buyer purchase or use SCILLC products for any such unintended or unauthorized application, Buyer shall indemnify and hold SCILLC and its officers, employees, subsidiaries, affiliates, and distributors harmless against all claims, costs, damages, and expenses, and reasonable attorney fees arising out of, directly or indirectly, any claim of personal injury or death associated with such unintended or unauthorized use, even if such claim alleges that SCILLC was negligent regarding the design or manufacture of the part. SCILLC is an Equal Opportunity/Affirmative Action Employer. This literature is subject to all applicable copyright laws and is not for resale in any manner.

PUBLICATION ORDERING INFORMATION

LITERATURE FULFILLMENT:

Literature Distribution Center for ON Semiconductor
P.O. Box 5163, Denver, Colorado 80217 USA
Phone: 303-675-2175 or 800-344-3860 Toll Free USA/Canada
Fax: 303-675-2176 or 800-344-3867 Toll Free USA/Canada
Email: orderlit@onsemi.com

N. American Technical Support: 800-282-9855 Toll Free
USA/Canada
Europe, Middle East and Africa Technical Support:
Phone: 421 33 790 2910
Japan Customer Focus Center
Phone: 81-3-5817-1050

ON Semiconductor Website: www.onsemi.com

Order Literature: <http://www.onsemi.com/orderlit>

For additional information, please contact your local Sales Representative