

# Current-Shunt Monitors, 40 V Common Mode, Unidirectional, Single, Dual, Quad

## NCS21673, NCV21673, NCS21674, NCV21674, NCS21675, NCV21675

The NCS21673, NCS21674, and NCS21675 are a series of current sense amplifiers offered in gains of 20, 50, 100, and 200 V/V. These parts can measure voltage across shunts at common mode voltages from -0.1 V to 40 V, independent of supply voltage. This helps measuring of fast transients and allows the same type of part to be used for high side and low side current sensing. These devices can operate from a single 2.7 V to 5.5 V power supply. With a -3 dB BW of up to 350 kHz and a Slew Rate of 2 V/ $\mu$ s typical, the fast detection of current changes is ensured. These parts are available in SOT23-5, Micro8, and TSSOP-14 packages. The multichannel versions (dual and quad) make current sensing in multiple points of a system both space and cost effective.

### Features

- Wide Common Mode Input Range: -0.1 V to 40 V
- Supply Voltage Range: 2.7 V to 5.5 V
- Low Offset Voltage:  $\pm 100 \mu$ V
- Low Offset Drift:  $\pm 1 \mu$ V/ $^{\circ}$ C max
- Low Gain Error:  $\pm 1\%$  max
- Low Current Consumption: 300  $\mu$ A max per channel
- NCV Prefix for Automotive Grade 1 and Other Applications Requiring Unique Site and Control Change Requirements; AEC-Q100 Qualified and PPAP Capable
- These Devices are Pb-Free, Halogen Free/BFR Free and are RoHS Compliant

### Applications

- High-Side Current Sensing
- Low-Side Current Sensing
- Power Management
- Automotive

### MARKING DIAGRAMS

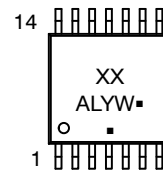
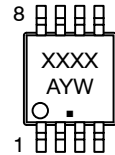
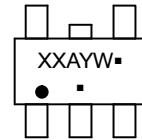

- XX = Specific Device Code
- A = Assembly Location
- L = Wafer Lot
- Y = Year
- W = Work Week
- = Pb-Free Package

(Note: Microdot may be in either location)

### PIN CONNECTIONS

See pin connections on page 2 of this data sheet.

### ORDERING INFORMATION

See detailed ordering and shipping information on page 3 of this data sheet.

**NCS21673, NCV21673, NCS21674, NCV21674, NCS21675, NCV21675**

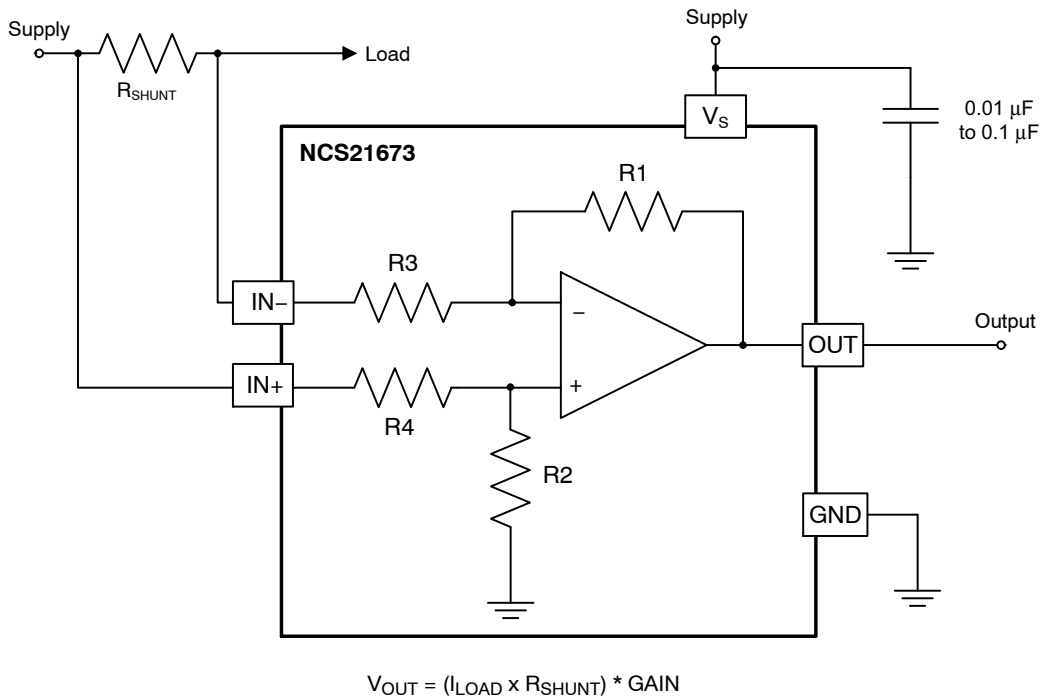

**Figure 1. Example Application Schematic of High-Side Current Sensing**

**PIN CONNECTIONS**

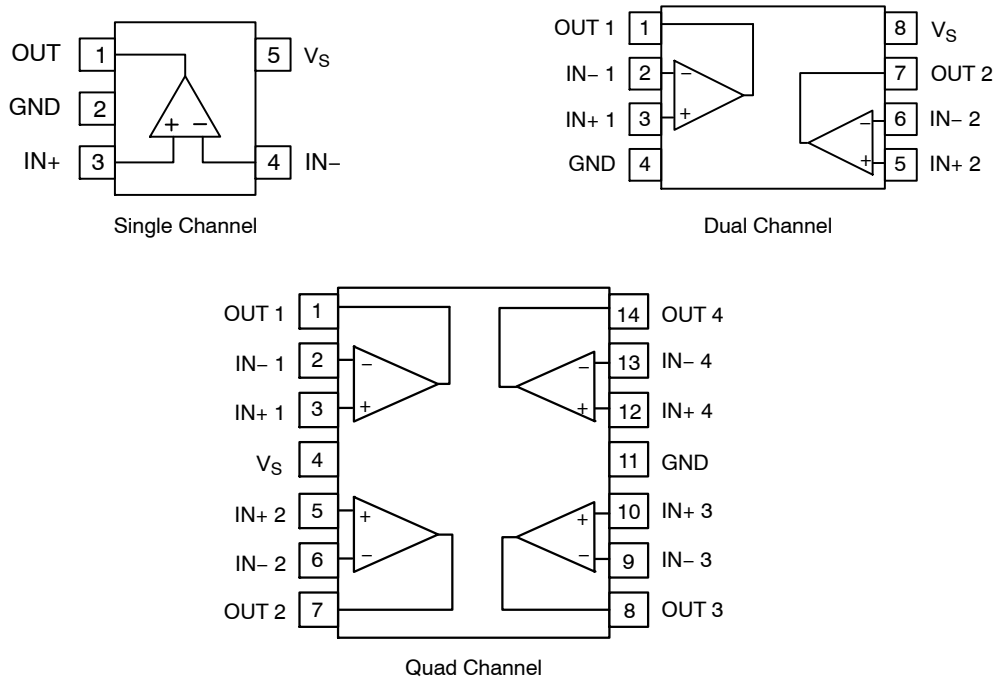

**Figure 2. Pin Connections**

# NCS21673, NCV21673, NCS21674, NCV21674, NCS21675, NCV21675

## ORDERING INFORMATION

Device	Channels	Package	Gain	OPN	Marking	Shipping
<b>Industrial and Consumer</b>						
NCS21673	Single	TSOP-5	20	NCS21673SN2G020T1G**	TBD	Tape and Reel 3000/reel
			50	NCS21673SN2G050T1G**	TBD	
			100	NCS21673SN2G100T1G**	TBD	
			200	NCS21673SN2G200T1G**	TBD	
NCS21674	Dual	Micro8	20	NCS21674DMG020R2G**	G020	Tape and Reel 4000/reel
			50	NCS21674DMG050R2G**	G050	
			100	NCS21674DMG100R2G**	G100	
			200	NCS21674DMG200R2G	G200	
NCS21675	Quad	TSSOP-14	20	NCS21675DTBG020R2G**	TBD	Tape and Reel 2500/reel
			50	NCS21675DTBG050R2G**	TBD	
			100	NCS21675DTBG100R2G**	TBD	
			200	NCS21675DTBG200R2G**	TBD	

### Automotive Qualified

NCV21673*	Single	TSOP-5	20	NCV21673SN2G020T1G**	TBD	Tape and Reel 3000/reel
			50	NCV21673SN2G050T1G**	TBD	
			100	NCV21673SN2G100T1G**	TBD	
			200	NCV21673SN2G200T1G**	TBD	
NCV21674*	Dual	Micro8	20	NCV21674DMG020R2G**	G020	Tape and Reel 4000/reel
			50	NCV21674DMG050R2G**	G050	
			100	NCV21674DMG100R2G**	G100	
			200	NCV21674DMG200R2G**	G200	
NCV21675*	Quad	TSSOP-14	20	NCV21675DTBG020R2G**	TBD	Tape and Reel 2500/reel
			50	NCV21675DTBG050R2G**	TBD	
			100	NCV21675DTBG100R2G**	TBD	
			200	NCV21675DTBG200R2G**	TBD	

†For information on tape and reel specifications, including part orientation and tape sizes, please refer to our Tape and Reel Packaging Specifications Brochure, BRD8011/D.

\*NCV Prefix for Automotive and Other Applications Requiring Unique Site and Control Change Requirements; AEC-Q100 Qualified and PPAP Capable

\*\*In Development

# NCS21673, NCV21673, NCS21674, NCV21674, NCS21675, NCV21675

## MAXIMUM RATINGS

Parameter		Symbol	Rating	Unit
Supply Voltage (Note 1)		$V_S$	-0.3 to 5.5	V
Analog Inputs	Differential ( $V_{IN+}$ )-( $V_{IN-}$ ) (Note 2)	$V_{IN+}, V_{IN-}$	$\pm 42$	V
	Common-Mode (Note 2)		-0.3 to +42	
Output (Note 2)		$V_{OUT}$	GND-0.3 to ( $V_S$ ) +0.3	V
Input Current into Any Pin (Note 2)		$I_{IN}$	$\pm 10$	mA
Maximum Junction Temperature		$T_{J(max)}$	+150	°C
Storage Temperature Range		$T_{STG}$	-65 to +150	°C
ESD Capability, Human Body Model (Note 3)		HBM	$\pm 2000$	V
Charged Device Model (Note 3)		CDM	$\pm 1000$	V
Latch-up Current (Note 4)			$\pm 100$	mA

Stresses exceeding those listed in the Maximum Ratings table may damage the device. If any of these limits are exceeded, device functionality should not be assumed, damage may occur and reliability may be affected.

1. Refer to ELECTRICAL CHARACTERISTICS, RECOMMENDED OPERATING RANGES and/or APPLICATION INFORMATION for safe operating parameters
2. Input voltage at any pin may exceed the voltage shown if current at that pin is limited to  $\pm 10$  mA
3. This device series incorporates ESD protection and is tested by the following methods:  
 ESD Human Body Model tested per JEDEC standard JS-001-2017  
 ESD Charged Device Model tested per JEDEC standard JS-002-2014
4. Latch-up Current tested per JEDEC standard: JESD78E

## THERMAL CHARACTERISTICS

Parameter	Symbol	Package	Value	Unit
Thermal Resistance, Junction-to-Air (Notes 5, 6)	$\theta_{JA}$	TSOP-5 / SOT23-5	210	°C/W
		Micro8 / MSOP-8	195	
		TSSOP-14	TBD	

5. Refer to ELECTRICAL CHARACTERISTICS, RECOMMENDED OPERATING RANGES and/or APPLICATION INFORMATION for safe operating parameters
6. Values based on copper area of 645 mm<sup>2</sup> (or 1 in<sup>2</sup>) of 1 oz copper thickness and FR4 PCB substrate

## RECOMMENDED OPERATING RANGES

Parameter	Symbol	Conditions	Min	Max	Unit
Ambient Temperature	$T_A$	NCS prefix	-40	125	°C
		NCV prefix	-40	150*	
Common Mode Input Voltage	$V_{CM}$	$T_a = -40^\circ\text{C}$ to $+125^\circ\text{C}$	-0.1	40	V
Supply Voltage	$V_S$	$T_a = -40^\circ\text{C}$ to $+125^\circ\text{C}$	2.7	5.5	V
		$T_a = 0^\circ\text{C}$ to $+85^\circ\text{C}$	1.8	5.5	

Functional operation above the stresses listed in the Recommended Operating Ranges is not implied. Extended exposure to stresses beyond the Recommended Operating Ranges limits may affect device reliability.

\*During operation at  $T_a = 150^\circ\text{C}$ , also the limitation for junction temperature ( $T_{J(max)} = 150^\circ\text{C}$ ) has to be considered.

# NCS21673, NCV21673, NCS21674, NCV21674, NCS21675, NCV21675

## ELECTRICAL CHARACTERISTICS

At  $T_A = +25^\circ\text{C}$ ,  $V_{\text{SENSE}} = (V_{\text{IN}+}) - (V_{\text{IN}-})$ ;  $V_S = 5\text{ V}$ ,  $V_{\text{IN}+} = 12\text{ V}$ , unless otherwise noted. **Boldface** limits apply over the specified temperature range,  $T_A = -40^\circ\text{C}$  to  $125^\circ\text{C}$  unless otherwise noted, guaranteed by characterization and/or design.

Parameter	Symbol	Conditions	Min	Typ	Max	Unit		
<b>Input</b>								
Common Mode Rejection Ratio	CMRR	$V_{\text{IN}+} = -0.1\text{ V to }40\text{ V}$ , $V_{\text{SENSE}} = 0\text{ mV}$	G = 20	84	100		dB	
				<b>84</b>				
			G = 50	84	100			
				<b>84</b>				
			G = 100	84	100			
				<b>84</b>				
			G = 200	84	100			
				<b>84</b>				
Input Offset Voltage	$V_{\text{OS}}$	$T_A = 25^\circ\text{C}$ , $V_{\text{IN}+} = 12\text{ V}$	G = 20		$\pm 100$	$\pm 500$	$\mu\text{V}$	
			G = 50		$\pm 100$	$\pm 500$		
			G = 100		$\pm 100$	$\pm 500$		
			G = 200		$\pm 100$	$\pm 500$		
		$T_A = 25^\circ\text{C}$ , $V_{\text{IN}+} = 0\text{ V}$	G = 20		$\pm 25$	TBD		
			G = 50		$\pm 25$	TBD		
			G = 100		$\pm 25$	TBD		
			G = 200		$\pm 25$	$\pm 210$		
Input Offset Voltage Drift vs. Temperature	$dV_{\text{OS}}/dT$	$T_A = -40^\circ\text{C to }+125^\circ\text{C}$		0.2	1	$\mu\text{V}/^\circ\text{C}$		
Power Supply Rejection Ratio	PSRR	$V_S = 2.7\text{ V to }5.5\text{ V}$ , $V_{\text{SENSE}} = 10\text{ mV}$		$\pm 8$	<b><math>\pm 40</math></b>	$\mu\text{V/V}$		
Input Bias Current	$I_{\text{IB}}$	$V_{\text{IN}+} = 0\text{ V}$		1		$\mu\text{A}$		
		$V_{\text{IN}+} = 12\text{ V}$		100				
Input Offset Current	$I_{\text{IO}}$	$V_{\text{IN}+} = 12\text{ V}$ , $V_{\text{SENSE}} = 10\text{ mV}$		15		$\mu\text{A}$		

## Output

Gain	G	G = 20		20		V/V
		G = 50		50		
		G = 100		100		
		G = 200		200		
Gain Error		$T_A = 25^\circ\text{C}$		$\pm 0.1$		%
		$T_A = -40^\circ\text{C to }+125^\circ\text{C}$			<b><math>\pm 1</math></b>	
Gain Error vs Temperature		$T_A = -40^\circ\text{C to }+125^\circ\text{C}$		1.5	<b>20</b>	ppm/ $^\circ\text{C}$
Nonlinearity Error				$\pm 0.01$		%
Maximum Capacitive Load	$C_L$	No sustained oscillation		1		nF
Settling Time to 1%				5		$\mu\text{s}$

## Voltage Output

Output Voltage High, Swing from $V_S$ Supply Rail	$V_S - V_{\text{OH}}$	$R_L = 10\text{ k}\Omega$ to GND, $T_A = 25^\circ\text{C}$		0.02		V
		$R_L = 10\text{ k}\Omega$ to GND, $T_A = -40^\circ\text{C to }125^\circ\text{C}$			<b>0.03</b>	
Output Voltage Low, Swing from GND	$V_{\text{OL}} - \text{GND}$	$R_L = 10\text{ k}\Omega$ to GND, $T_A = 25^\circ\text{C}$		0.0005		V
		$R_L = 10\text{ k}\Omega$ to GND, $T_A = -40^\circ\text{C to }125^\circ\text{C}$			<b>0.005</b>	

# NCS21673, NCV21673, NCS21674, NCV21674, NCS21675, NCV21675

## ELECTRICAL CHARACTERISTICS (continued)

At  $T_A = +25^\circ\text{C}$ ,  $V_{\text{SENSE}} = (V_{\text{IN}+}) - (V_{\text{IN}-})$ ;  $V_S = 5\text{ V}$ ,  $V_{\text{IN}+} = 12\text{ V}$ , unless otherwise noted. **Boldface** limits apply over the specified temperature range,  $T_A = -40^\circ\text{C}$  to  $125^\circ\text{C}$  unless otherwise noted, guaranteed by characterization and/or design.

Parameter	Symbol	Conditions	Min	Typ	Max	Unit
<b>Frequency Response</b>						
Bandwidth ( $f_{-3\text{dB}}$ )	BW	$C_L = 25\text{ pF}$	G = 20		350	kHz
			G = 50		210	
			G = 100		150	
			G = 200		105	
Slew Rate	SR			2		V/ $\mu\text{s}$
<b>Noise</b>						
Voltage Noise Density	$e_n$	G = 50 or higher		40		nV/ $\sqrt{\text{Hz}}$
		G = 20		TBD		
<b>Power Supply</b>						
Quiescent Current per Channel	$I_Q$	$T_A = 25^\circ\text{C}$		195	260	$\mu\text{A}$
		$T_A = -40^\circ\text{C}$ to $+125^\circ\text{C}$			<b>300</b>	

Product parametric performance is indicated in the Electrical Characteristics for the listed test conditions, unless otherwise noted. Product performance may not be indicated by the Electrical Characteristics if operated under different conditions.

# NCS21673, NCV21673, NCS21674, NCV21674, NCS21675, NCV21675

TYPICAL CHARACTERISTICS ( $T_A = 25^\circ\text{C}$ ,  $V_S = 5\text{ V}$ , and  $V_{IN+} = 12\text{ V}$  unless otherwise noted)

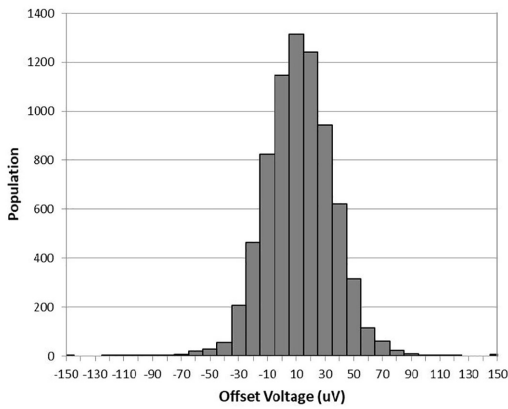

Figure 3. Input Offset Production Distribution G200

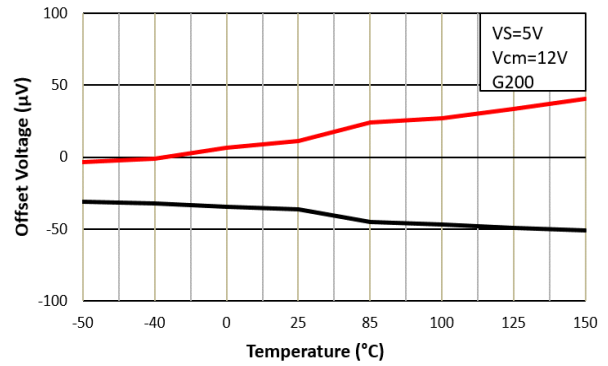

Figure 4. Offset Voltage vs. Temperature

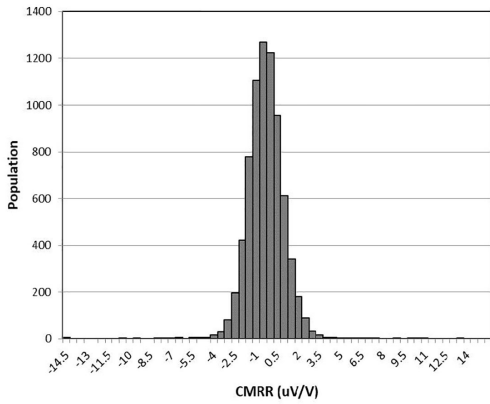

Figure 5. CMRR Production Distribution G200

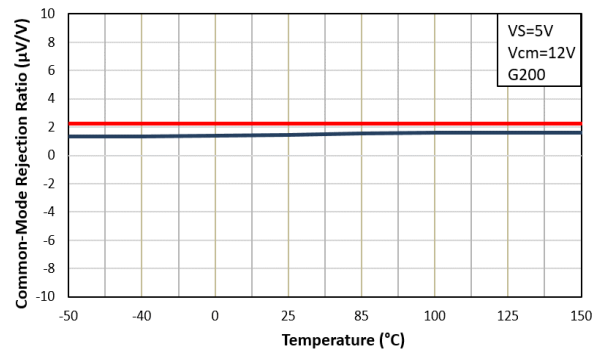

Figure 6. CMRR vs. Temperature

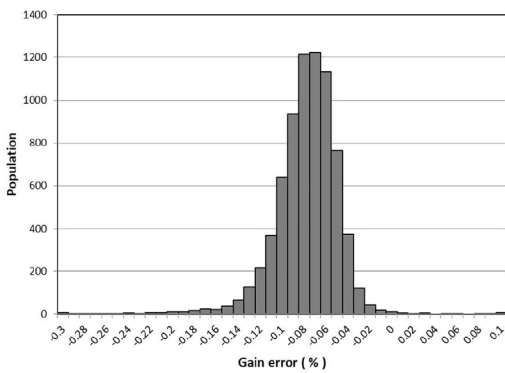

Figure 7. Gain Error Production Distribution G200

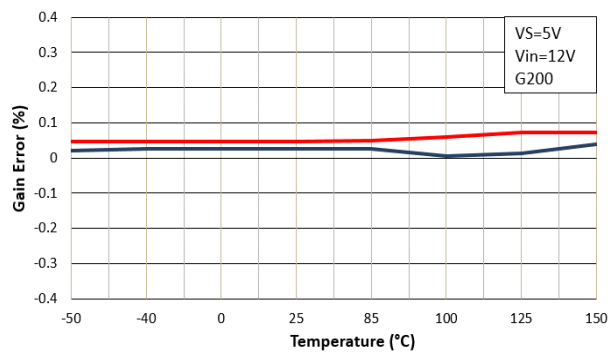

Figure 8. Gain Error vs. Temperature

# NCS21673, NCV21673, NCS21674, NCV21674, NCS21675, NCV21675

TYPICAL CHARACTERISTICS ( $T_A = 25^\circ\text{C}$ ,  $V_S = 5\text{ V}$ , and  $V_{IN+} = 12\text{ V}$  unless otherwise noted) (continued)

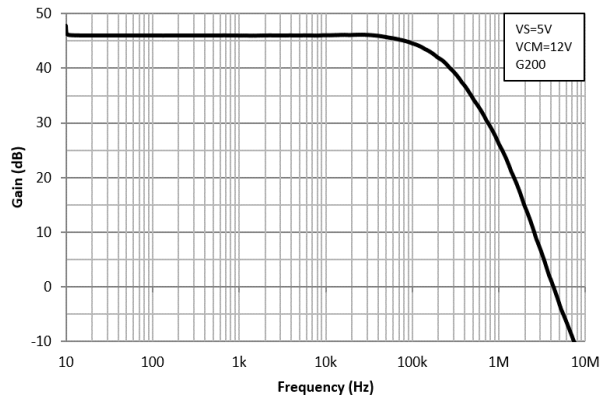

Figure 9. Gain vs. Frequency

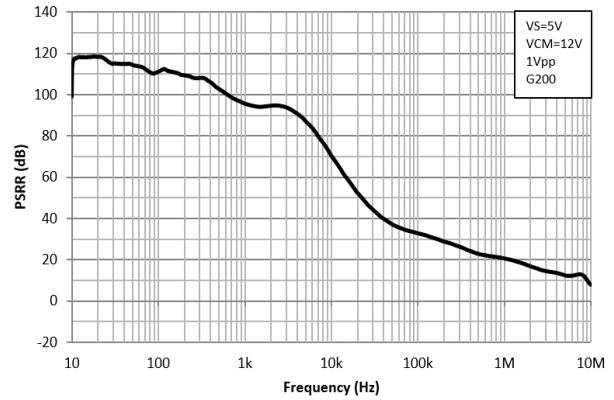

Figure 10. Power Supply Rejection Ratio vs. Frequency

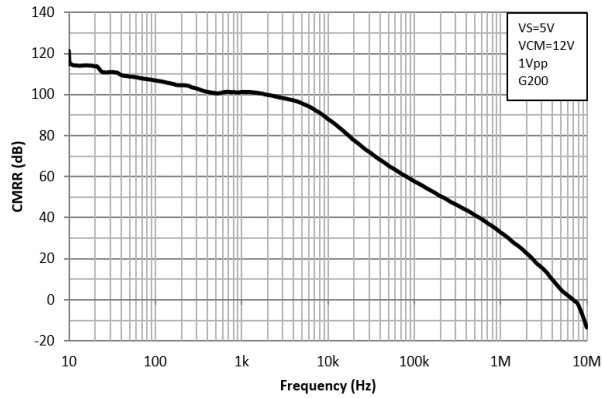

Figure 11. Common Mode Rejection Ratio vs. Frequency

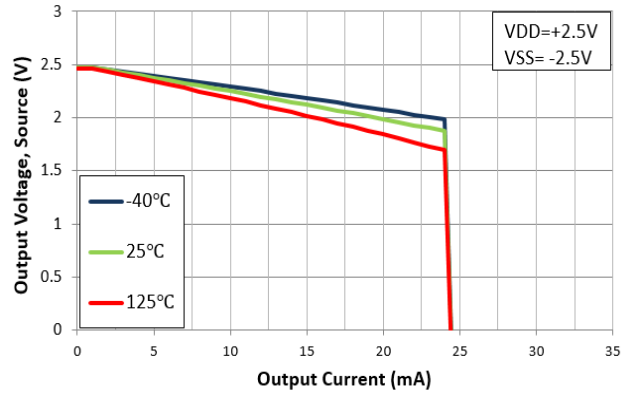

Figure 12. Output High Swing vs. Output Current

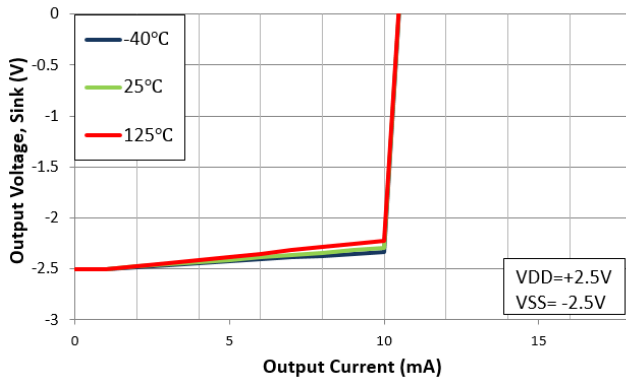

Figure 13. Output Low Swing vs. Output Current

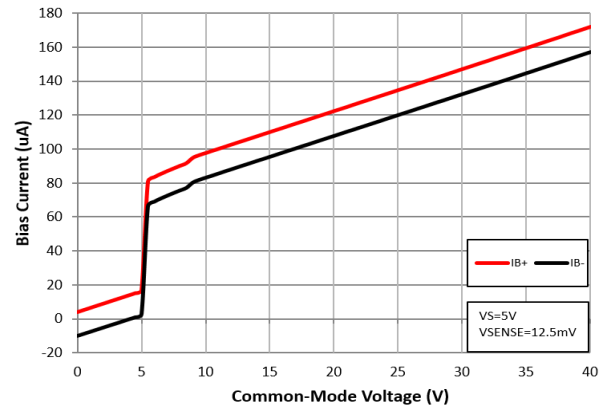

Figure 14. Input Bias Current vs. Common-Mode Voltage



# NCS21673, NCV21673, NCS21674, NCV21674, NCS21675, NCV21675

TYPICAL CHARACTERISTICS ( $T_A = 25^\circ\text{C}$ ,  $V_S = 5\text{ V}$ , and  $V_{IN+} = 12\text{ V}$  unless otherwise noted) (continued)

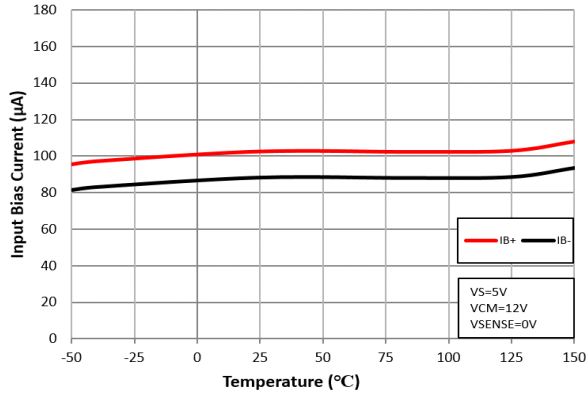

Figure 15. Input Bias Current vs. Temperature

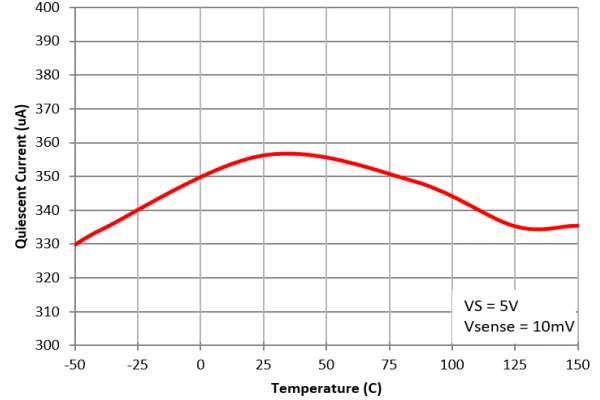

Figure 16. Quiescent Current vs. Temperature

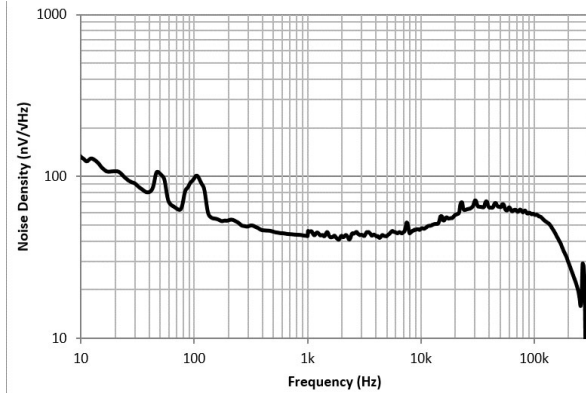

Figure 17. Input-Referred Voltage Noise vs. Frequency

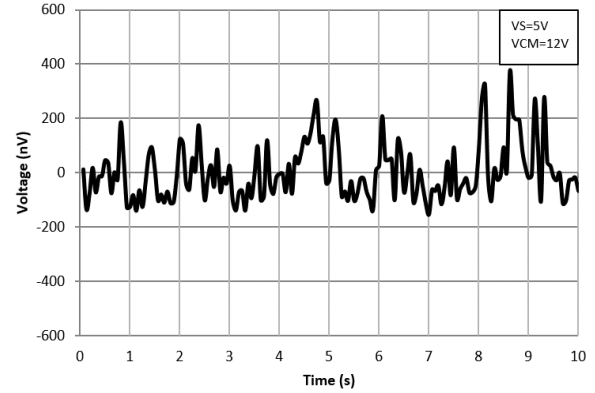

Figure 18. 0.1-Hz to 10-Hz Voltage Noise (Referred-to-Input)

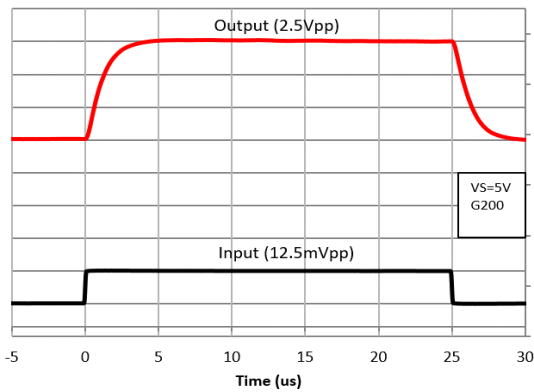

Figure 19. Input Signal Step response

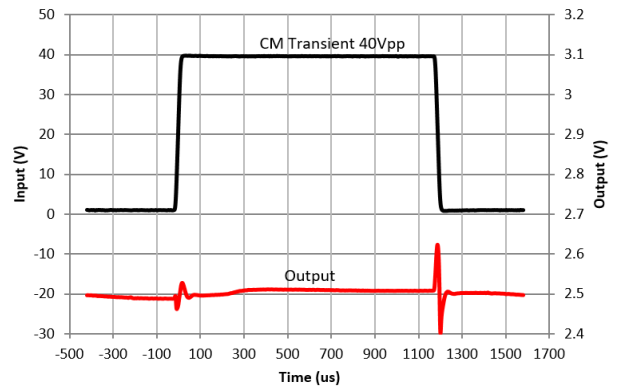

Figure 20. Common-Mode Voltage Transient Response

# NCS21673, NCV21673, NCS21674, NCV21674, NCS21675, NCV21675

TYPICAL CHARACTERISTICS ( $T_A = 25^\circ\text{C}$ ,  $V_S = 5\text{ V}$ , and  $V_{IN+} = 12\text{ V}$  unless otherwise noted) (continued)

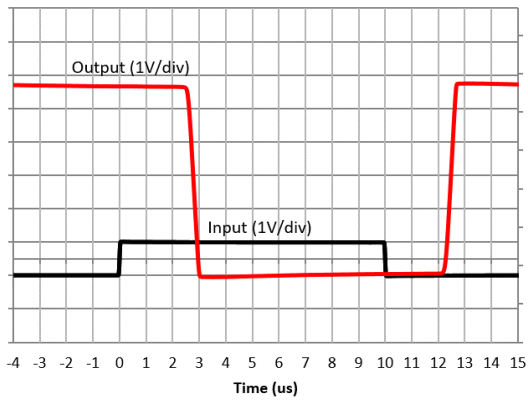

Figure 21. Inverting Differential Input Overload

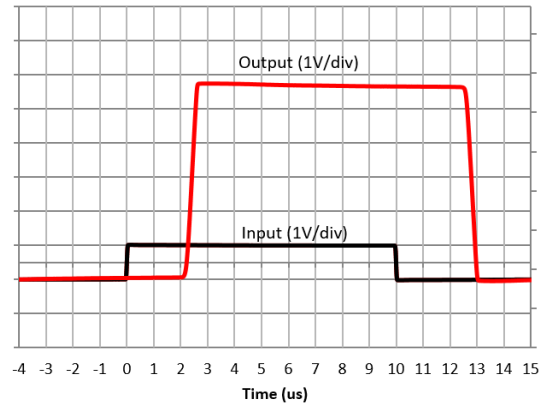

Figure 22. Noninverting Differential Input Overload

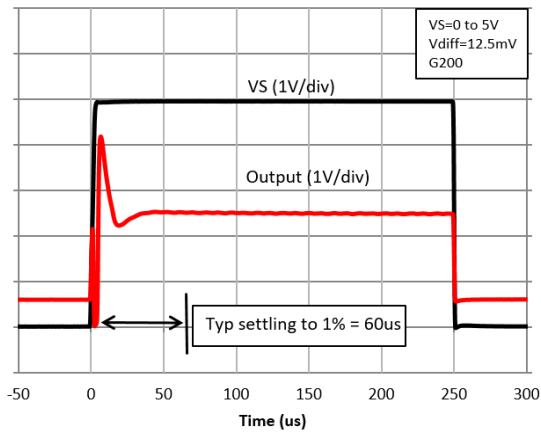

Figure 23. Start-Up Response

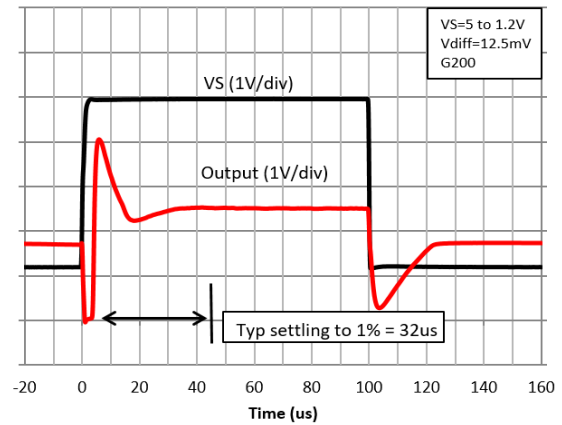

Figure 24. Brownout Recovery

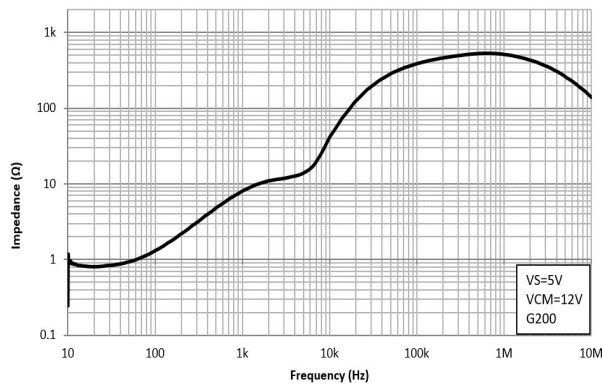

Figure 25. Output Impedance vs. Frequency

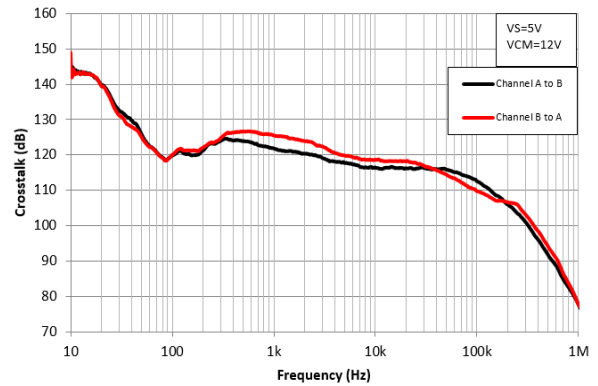
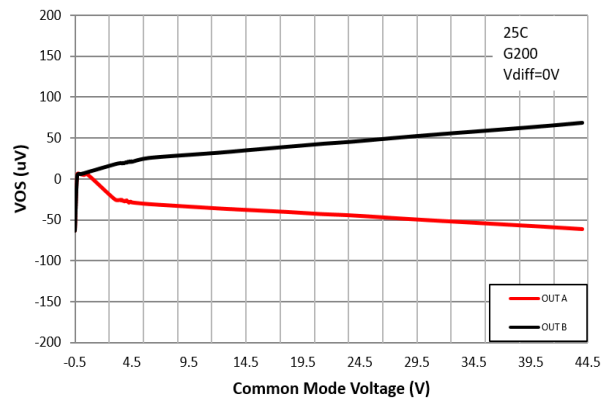

Figure 26. Channel Separation vs. Frequency

# NCS21673, NCV21673, NCS21674, NCV21674, NCS21675, NCV21675

**TYPICAL CHARACTERISTICS** ( $T_A = 25^\circ\text{C}$ ,  $V_S = 5\text{ V}$ , and  $V_{IN+} = 12\text{ V}$  unless otherwise noted) (continued)



**Figure 27. Output Voltage vs. Common-Mode Voltage**

APPLICATION INFORMATION

**Current Sensing Techniques**

NCS(V)21673, NCS(V)21674, and NCS(V)21675 are current sense amplifiers featuring a wide common mode voltage range that spans from -0.1 V to 40 V independent of the supply voltage. These amplifiers can be configured for low-side and high-side current sensing.

**Unidirectional Operation**

These current sense amplifiers monitor unidirectional current flow. In unidirectional current sensing, the measured load current always flows in the same direction. Common applications for unidirectional operation include power supplies and load current monitoring. In this configuration, the IN+ pin should be connected to the high side of the sense resistor, while the IN- pin should be connected to the low side of the sense resistor.

**Input Filtering**

As shunt resistors decrease in value, shunt inductance can significantly affect frequency response. At values below 1 mΩ, the shunt inductance causes a zero in the transfer function that often results in corner frequencies in the low 100's of kHz. This inductance increases the amplitude of high frequency spike transient events on the current sensing line that can overload the front end of any shunt current sensing IC. This problem must be solved by the external filtering at the input of the amplifier. Note that all current sensing IC's are vulnerable to this problem, regardless of manufacturer claims. Filtering is required at the input of the device to resolve this problem, even if the spike frequencies are above the rated -3 dB bandwidth of the device.

Ideally, select the capacitor to exactly match the time constant of the shunt resistor and its inductance; alternatively, select the capacitor to provide a pole below that point. Make the input filter time constant equal to or larger than the shunt and its inductance time constant:

$$\frac{L_{SHUNT}}{R_{SHUNT}} \leq R_{FILT}C_{FILT}$$

While this time constant can be the product of any R<sub>FILT</sub> and C<sub>FILT</sub> values, the designer needs to take into account that the R<sub>FILT</sub> resistors are connected in series with the internal feedback resistors R3 and R4, hence changing the amplifier's overall gain. Also, the opamp's input currents (IIB) create a voltage drop across the filtering resistors, which is added to the differential voltage seen by the opamp's inputs and modifies the output value. A good practice is to keep the filtering resistors in the range of a few ohms then size the filtering capacitor accordingly.

**Selecting the Shunt Resistor**

The desired accuracy of the current measurement determines the precision, shunt size, and the resistor value. The larger the resistor value, the more accurate the measurement possible, but a large resistor value also results in greater current loss.

For the most accurate measurements, use four-terminal current sense resistors. They provide two terminals for the current path in the application circuit, and a second pair for the voltage detection path of the sense amplifier. This technique is also known as *Kelvin Sensing*. This insures that the voltage measured by the sense amplifier is the actual voltage across the resistor and does not include the small resistance of a combined connection. When using non-Kelvin shunts, follow manufacturer recommendations on how to lay out the sensing traces closely.

**Gain Options**

The gain is set by integrated, precision, ratio-matched resistors. These current sense amplifiers are available in gain options of 20 V/V, 50 V/V, 100 V/V, and 200 V/V. Adding external resistors to adjust the gain can contribute to the overall system error and is not recommended for multiple reasons. First, the series resistors mismatch increase the overall gain error and temperature coefficient, and lower the CMRR. Second, the IIB flowing through the external resistors change the differential voltage seen by the opamp's input. Last but not least, while the internal resistors are well matched in terms of ratio, they have a high tolerance in their absolute value so the resulting gain value may not match the expectations.

**Shutdown**

While the NCS21673/4/5 series do not include a shutdown feature, a simple MOSFET, power switch, or logic gate can be used to switch off power and eliminate quiescent current. Note that the input pins connected to the shunt resistor will always have a current flow via the input and feedback resistors (total resistance of each leg always is approx. 400 kΩ). Also note that when powered, the shunt input pins will exhibit the specified and well-matched bias current. The shunt input pins support the rated common mode voltage even when the power is not applied.

PACKAGE DIMENSIONS

TSOP-5  
CASE 483  
ISSUE M

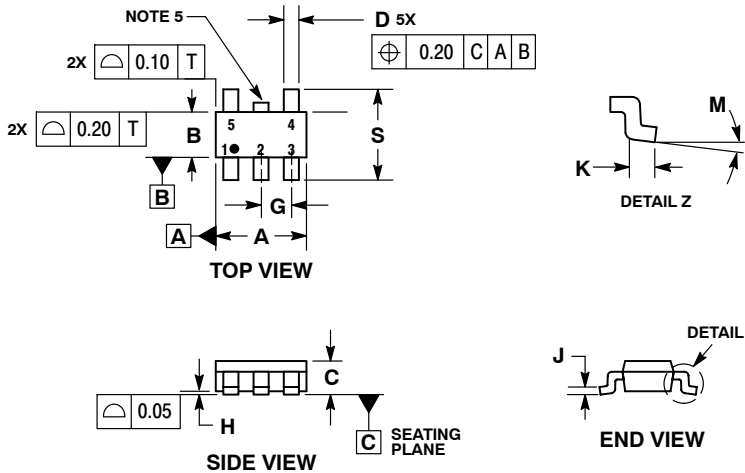

NOTES:

1. DIMENSIONING AND TOLERANCING PER ASME Y14.5M, 1994.
2. CONTROLLING DIMENSION: MILLIMETERS.
3. MAXIMUM LEAD THICKNESS INCLUDES LEAD FINISH THICKNESS. MINIMUM LEAD THICKNESS IS THE MINIMUM THICKNESS OF BASE MATERIAL.
4. DIMENSIONS A AND B DO NOT INCLUDE MOLD FLASH, PROTRUSIONS, OR GATE BURRS. MOLD FLASH, PROTRUSIONS, OR GATE BURRS SHALL NOT EXCEED 0.15 PER SIDE. DIMENSION A.
5. OPTIONAL CONSTRUCTION: AN ADDITIONAL TRIMMED LEAD IS ALLOWED IN THIS LOCATION. TRIMMED LEAD NOT TO EXTEND MORE THAN 0.2 FROM BODY.

DIM	MILLIMETERS	
	MIN	MAX
A	2.85	3.15
B	1.35	1.65
C	0.90	1.10
D	0.25	0.50
G	0.95 BSC	
H	0.01	0.10
J	0.10	0.26
K	0.20	0.60
M	0°	10°
S	2.50	3.00

SOLDERING FOOTPRINT\*

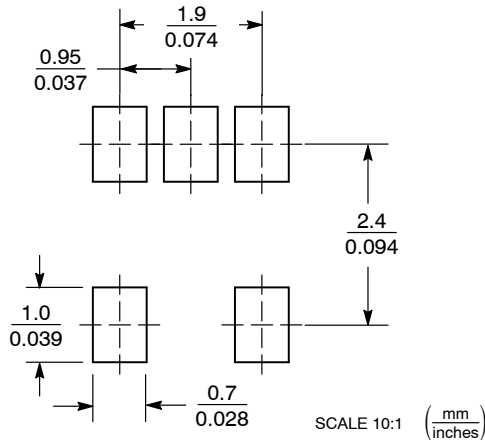

\*For additional information on our Pb-Free strategy and soldering details, please download the **onsemi** Soldering and Mounting Techniques Reference Manual, SOLDERRM/D.

PACKAGE DIMENSIONS

Micro8™  
CASE 846A-02  
ISSUE J

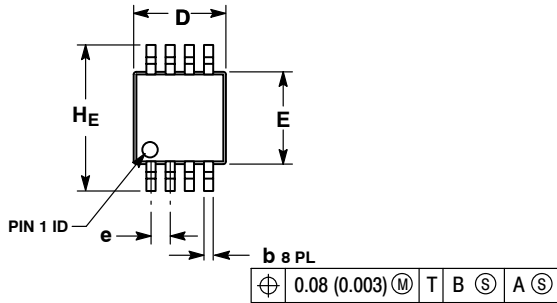

- NOTES:
1. DIMENSIONING AND TOLERANCING PER ANSI Y14.5M, 1982.
  2. CONTROLLING DIMENSION: MILLIMETER.
  3. DIMENSION A DOES NOT INCLUDE MOLD FLASH, PROTRUSIONS OR GATE BURRS. MOLD FLASH, PROTRUSIONS OR GATE BURRS SHALL NOT EXCEED 0.15 (0.006) PER SIDE.
  4. DIMENSION B DOES NOT INCLUDE INTERLEAD FLASH OR PROTRUSION. INTERLEAD FLASH OR PROTRUSION SHALL NOT EXCEED 0.25 (0.010) PER SIDE.
  5. 846A-01 OBSOLETE, NEW STANDARD 846A-02.

DIM	MILLIMETERS			INCHES		
	MIN	NOM	MAX	MIN	NOM	MAX
A	--	--	1.10	--	--	0.043
A1	0.05	0.08	0.15	0.002	0.003	0.006
b	0.25	0.33	0.40	0.010	0.013	0.016
c	0.13	0.18	0.23	0.005	0.007	0.009
D	2.90	3.00	3.10	0.114	0.118	0.122
E	2.90	3.00	3.10	0.114	0.118	0.122
e	0.65 BSC			0.026 BSC		
L	0.40	0.55	0.70	0.016	0.021	0.028
HE	4.75	4.90	5.05	0.187	0.193	0.199

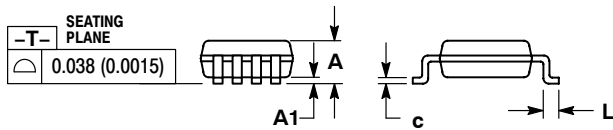

RECOMMENDED  
SOLDERING FOOTPRINT\*

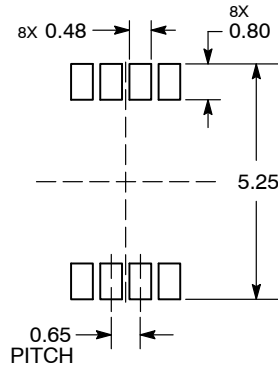

DIMENSION: MILLIMETERS

\*For additional information on our Pb-Free strategy and soldering details, please download the **onsemi** Soldering and Mounting Techniques Reference Manual, SOLDERRM/D.

PACKAGE DIMENSIONS

TSSOP-14 WB  
CASE 948G  
ISSUE C

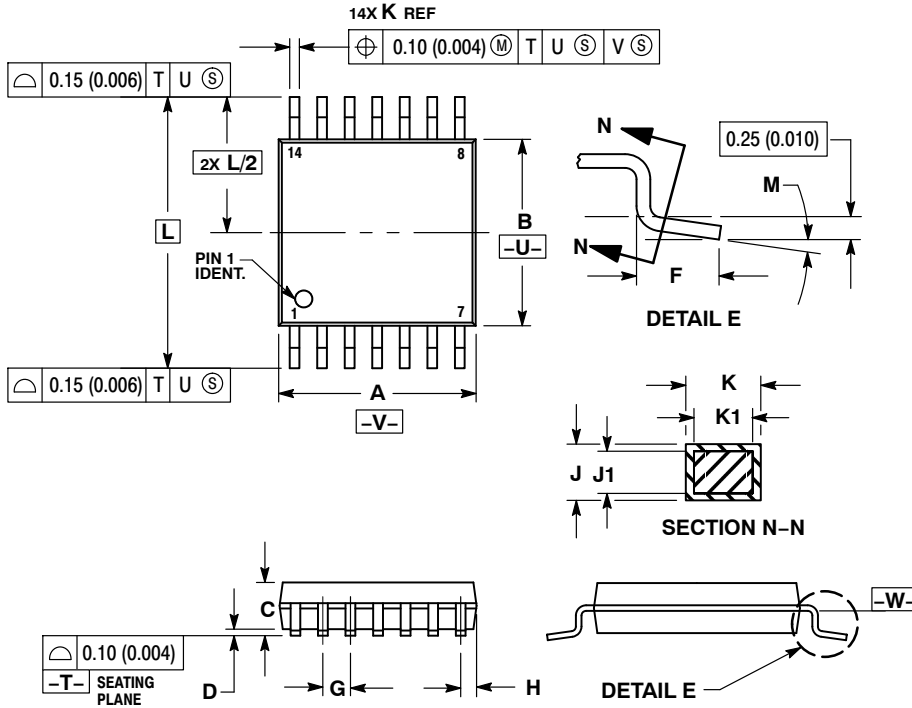

- NOTES:
1. DIMENSIONING AND TOLERANCING PER ANSI Y14.5M, 1982.
  2. CONTROLLING DIMENSION: MILLIMETER.
  3. DIMENSION A DOES NOT INCLUDE MOLD FLASH, PROTRUSIONS OR GATE BURRS. MOLD FLASH OR GATE BURRS SHALL NOT EXCEED 0.15 (0.006) PER SIDE.
  4. DIMENSION B DOES NOT INCLUDE INTERLEAD FLASH OR PROTRUSION. INTERLEAD FLASH OR PROTRUSION SHALL NOT EXCEED 0.25 (0.010) PER SIDE.
  5. DIMENSION K DOES NOT INCLUDE DAMBAR PROTRUSION. ALLOWABLE DAMBAR PROTRUSION SHALL BE 0.08 (0.003) TOTAL IN EXCESS OF THE K DIMENSION AT MAXIMUM MATERIAL CONDITION.
  6. TERMINAL NUMBERS ARE SHOWN FOR REFERENCE ONLY.
  7. DIMENSION A AND B ARE TO BE DETERMINED AT DATUM PLANE -W-.

DIM	MILLIMETERS		INCHES	
	MIN	MAX	MIN	MAX
A	4.90	5.10	0.193	0.200
B	4.30	4.50	0.169	0.177
C	---	1.20	---	0.047
D	0.05	0.15	0.002	0.006
F	0.50	0.75	0.020	0.030
G	0.65 BSC		0.026 BSC	
H	0.50	0.60	0.020	0.024
J	0.09	0.20	0.004	0.008
J1	0.09	0.16	0.004	0.006
K	0.19	0.30	0.007	0.012
K1	0.19	0.25	0.007	0.010
L	6.40 BSC		0.252 BSC	
M	0°	8°	0°	8°

SOLDERING FOOTPRINT

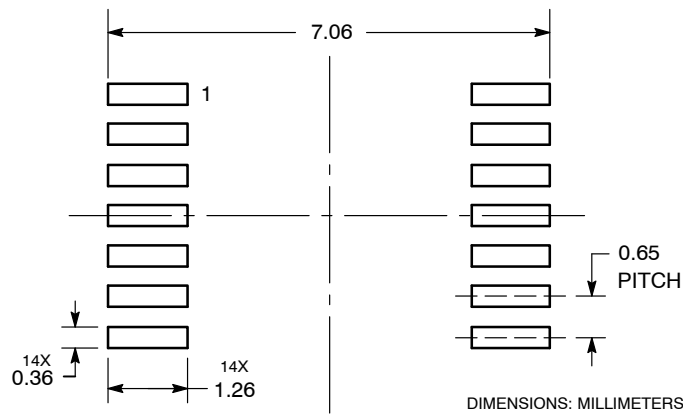

**onsemi**, **Onsemi**, and other names, marks, and brands are registered and/or common law trademarks of Semiconductor Components Industries, LLC dba "**onsemi**" or its affiliates and/or subsidiaries in the United States and/or other countries. **onsemi** owns the rights to a number of patents, trademarks, copyrights, trade secrets, and other intellectual property. A listing of **onsemi**'s product/patent coverage may be accessed at [www.onsemi.com/site/pdf/Patent-Marking.pdf](http://www.onsemi.com/site/pdf/Patent-Marking.pdf). **onsemi** reserves the right to make changes at any time to any products or information herein, without notice. The information herein is provided "as-is" and **onsemi** makes no warranty, representation or guarantee regarding the accuracy of the information, product features, availability, functionality, or suitability of its products for any particular purpose, nor does **onsemi** assume any liability arising out of the application or use of any product or circuit, and specifically disclaims any and all liability, including without limitation special, consequential or incidental damages. Buyer is responsible for its products and applications using **onsemi** products, including compliance with all laws, regulations and safety requirements or standards, regardless of any support or applications information provided by **onsemi**. "Typical" parameters which may be provided in **onsemi** data sheets and/or specifications can and do vary in different applications and actual performance may vary over time. All operating parameters, including "Typicals" must be validated for each customer application by customer's technical experts. **onsemi** does not convey any license under any of its intellectual property rights nor the rights of others. **onsemi** products are not designed, intended, or authorized for use as a critical component in life support systems or any FDA Class 3 medical devices or medical devices with a same or similar classification in a foreign jurisdiction or any devices intended for implantation in the human body. Should Buyer purchase or use **onsemi** products for any such unintended or unauthorized application, Buyer shall indemnify and hold **onsemi** and its officers, employees, subsidiaries, affiliates, and distributors harmless against all claims, costs, damages, and expenses, and reasonable attorney fees arising out of, directly or indirectly, any claim of personal injury or death associated with such unintended or unauthorized use, even if such claim alleges that **onsemi** was negligent regarding the design or manufacture of the part. **onsemi** is an Equal Opportunity/Affirmative Action Employer. This literature is subject to all applicable copyright laws and is not for resale in any manner.

## PUBLICATION ORDERING INFORMATION

### LITERATURE FULFILLMENT:

Email Requests to: [orderlit@onsemi.com](mailto:orderlit@onsemi.com)

**onsemi Website:** [www.onsemi.com](http://www.onsemi.com)

### TECHNICAL SUPPORT

**North American Technical Support:**  
Voice Mail: 1 800-282-9855 Toll Free USA/Canada  
Phone: 011 421 33 790 2910

**Europe, Middle East and Africa Technical Support:**

Phone: 00421 33 790 2910

For additional information, please contact your local Sales Representative