

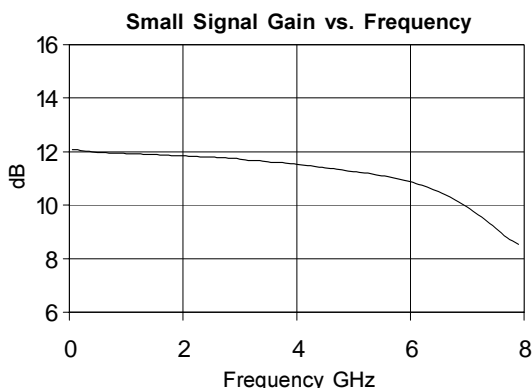

## Product Description

Sirenza Microdevices' NGA-689 is a high performance Gallium Arsenide Heterojunction Bipolar Transistor MMIC Amplifier. Designed with InGaP process technology for improved reliability, a Darlington configuration is utilized for broadband performance up to 5 GHz. The heterojunction increases breakdown voltage and minimizes leakage current between junctions. Cancellation of emitter junction non-linearities results in higher suppression of intermodulation products.



## NGA-689

**DC-5000 MHz, Cascadable GaAs HBT MMIC Amplifier**



# OBSOLETE

See Application Note AN-059 for Alternates

### Product Features

- 11.7dB Gain, 18.9 dBm P1dB at 1950Mhz
- Cascadable 50 ohm: 1.4:1 VSWR
- Operates from Single Supply
- Low Thermal Resistance Package
- Unconditionally Stable

### Applications

- PA Driver Amplifier
- Cellular, PCS, GSM, UMTS
- IF Amplifier
- Wireless Data, Satellite

Symbol	Parameter	Units	Frequency	Min.	Typ.	Max.	
P <sub>1dB</sub>	Output Power at 1dB Compression	dBm	850 MHz		19.9		
			1950 MHz		18.9		
			2400 MHz		17.9		
OIP <sub>3</sub>	Output Third Order Intercept Point	dBm	850 MHz		36.9		
			1950 MHz		33.6		
			2400 MHz		32.1		
G	Small Signal Gain	dB	850 MHz	10.7	11.9	13.1	
			1950 MHz		11.7		
			2400 MHz		11.6		
Bandwidth	Determined by Return Loss (>10dB)	MHz			5000		
				DC - 5000 MHz		1.4:1	
				DC - 5000 MHz		1.4:1	
NF	Noise Figure	dB	2000 MHz		6.0		
V <sub>D</sub>	Device Operating Voltage	V		5.2	5.8	6.5	
I <sub>D</sub>	Device Operating Current	mA		72	80	88	
R <sub>TH</sub> J-I	Thermal Resistance (junction to lead)	°C/W			91		

**Test Conditions:**

$$V_S = 8 \text{ V}$$

$$R_{BIAS} = 27 \text{ Ohms}$$

$$I_D = 80 \text{ mA Typ.}$$

$$T_L = 25^\circ\text{C}$$

$$OIP_3 \text{ Tone Spacing} = 1 \text{ MHz, } P_{out} \text{ per tone} = 0 \text{ dBm}$$

$$Z_S = Z_L = 50 \text{ Ohms}$$

The information provided herein is believed to be reliable at press time. Sirenza Microdevices assumes no responsibility for inaccuracies or omissions. Sirenza Microdevices assumes no responsibility for the use of this information, and all such information shall be entirely at the user's own risk. Prices and specifications are subject to change without notice. No patent rights or licenses to any of the circuits described herein are implied or granted to any third party. Sirenza Microdevices does not authorize or warrant any Sirenza Microdevices product for use in life-support devices and/or systems. Copyright 2001 Sirenza Microdevices, Inc. All worldwide rights reserved.

**Key parameters, at typical operating frequencies:**

Parameter	Typical 25°C	Units	Test Condition ( $I_D = 80\text{mA}$ , unless otherwise noted)
<b>500 MHz</b>			
Gain	12.0	dB	Tone spacing = 1 MHz, Pout per tone = 0dBm
Output IP3	37.2	dBm	
Output P1dB	19.9	dBm	
Input Return Loss	19.6	dB	
Reverse Isolation	19.7	dB	
<b>850 MHz</b>			
Gain	11.9	dB	Tone spacing = 1 MHz, Pout per tone = 0dBm
Output IP3	36.9	dBm	
Output P1dB	19.9	dBm	
Input Return Loss	18.5	dB	
Reverse Isolation	19.7	dB	
<b>1950 MHz</b>			
Gain	11.7	dB	Tone spacing = 1 MHz, Pout per tone = 0dBm
Output IP3	33.6	dBm	
Output P1dB	18.9	dBm	
Input Return Loss	16.0	dB	
Reverse Isolation	19.5	dB	
<b>2400 MHz</b>			
Gain	11.6	dB	Tone spacing = 1 MHz, Pout per tone = 0dBm
Output IP3	32.1	dBm	
Output P1dB	17.9	dBm	
Input Return Loss	15.9	dB	
Reverse Isolation	19.4	dB	

**Absolute Maximum Ratings**

Parameter	Absolute Limit
Max. Device Current ( $I_D$ )	120 mA
Max. Device Voltage ( $V_D$ )	7 V
Max. RF Input Power	+13 dBm
Max. Junction Temp. ( $T_J$ )	+150°C
Operating Temp. Range ( $T_L$ )	-40°C to +85°C
Max. Storage Temp.	+150°C

Operation of this device beyond any one of these limits may cause permanent damage. For reliable continuous operation, the device voltage and current must not exceed the maximum operating values specified in the table on page one.

Bias Conditions should also satisfy the following expression:

$$I_D V_D < (T_J - T_L) / R_{TH} \text{ j-1}$$

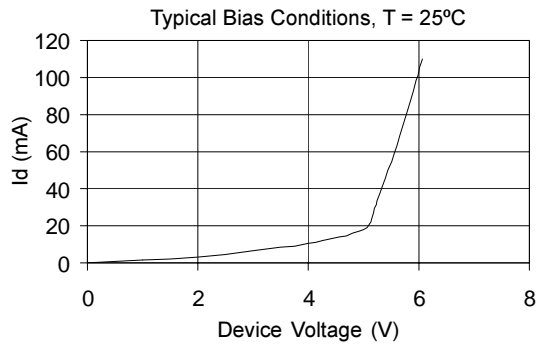
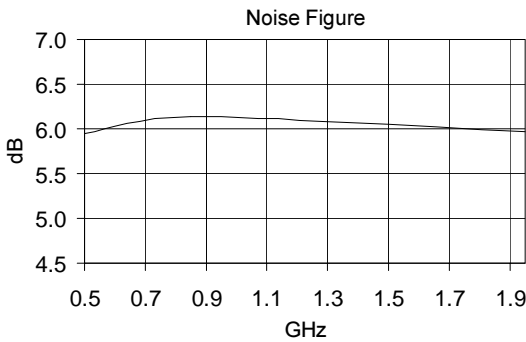
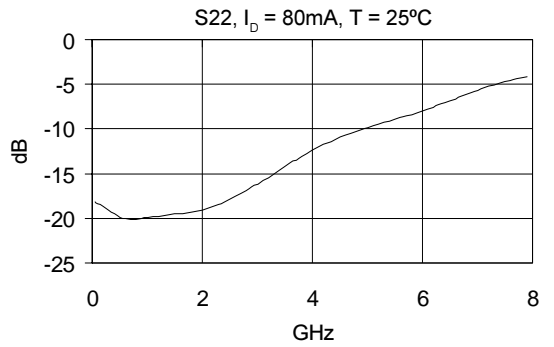
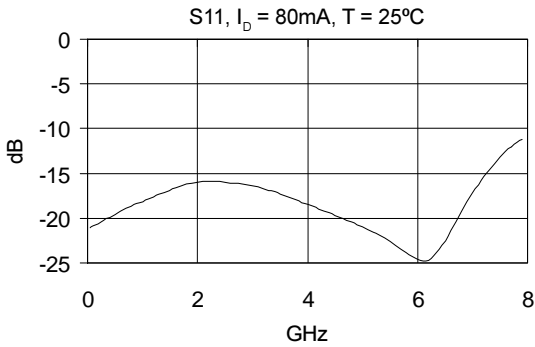
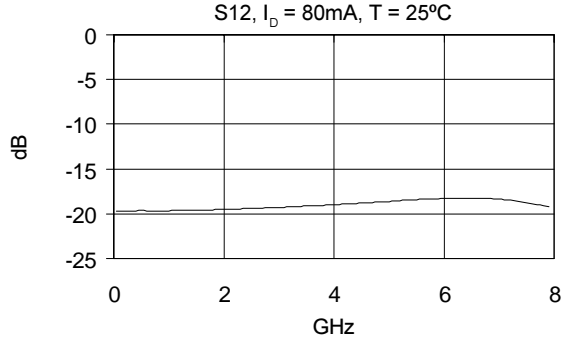
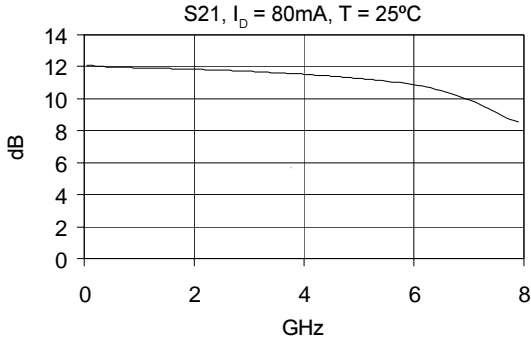

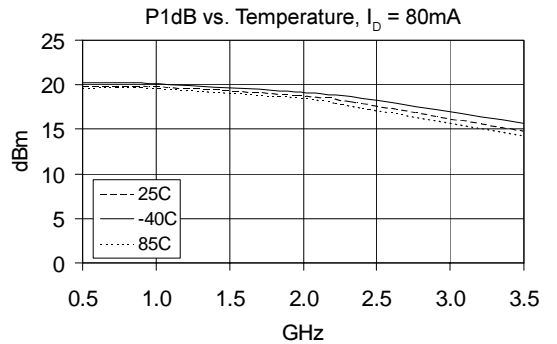
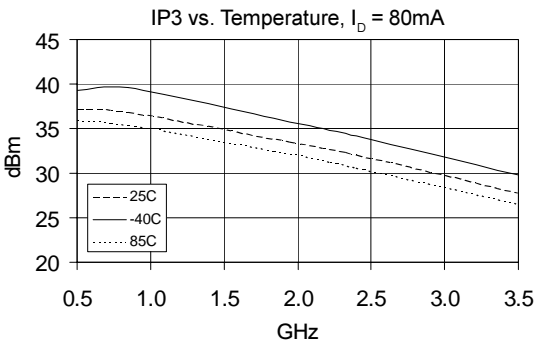
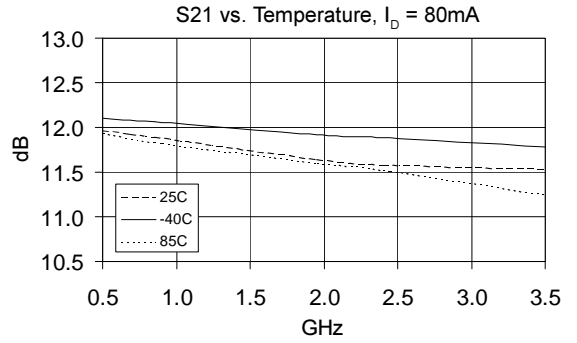
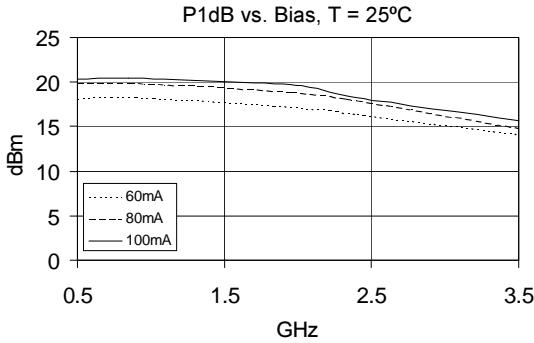
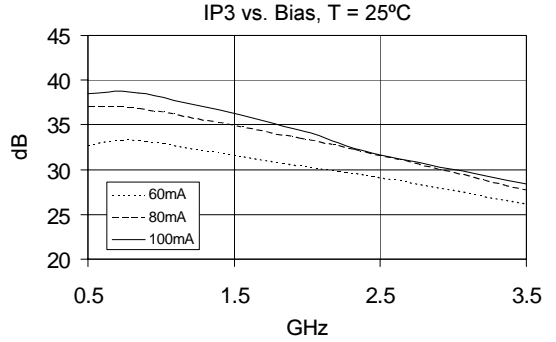
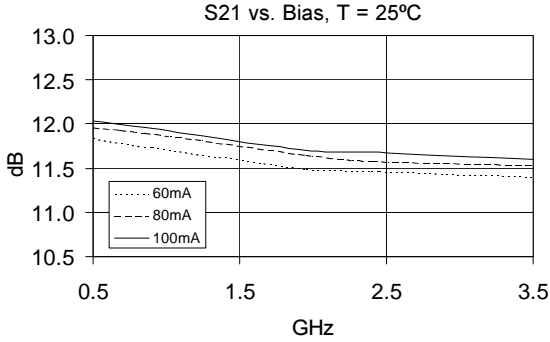

## Basic Application Circuit

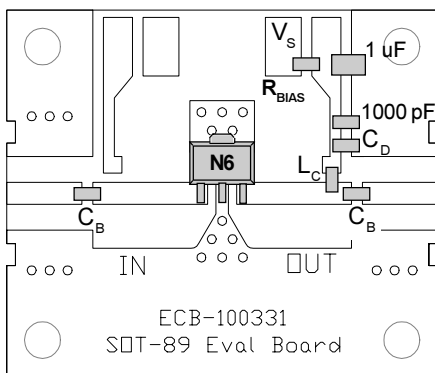
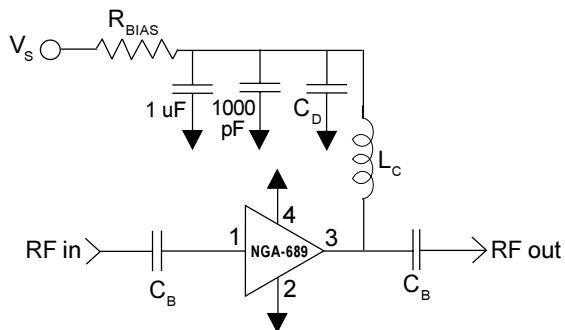

### Part Identification Marking

The part will be marked with an "N6" designator on the top surface of the package.

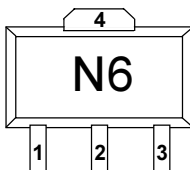

For package dimensions, refer to outline drawing at [www.sirenza.com](http://www.sirenza.com)



### Caution: ESD sensitive

Appropriate precautions in handling, packaging and testing devices must be observed.

### Application Circuit Element Values

Reference Designator	Frequency (Mhz)				
	500	850	1950	2400	3500
C <sub>B</sub>	220 pF	100 pF	68 pF	56 pF	39 pF
C <sub>D</sub>	100 pF	68 pF	22 pF	22 pF	15 pF
L <sub>C</sub>	68 nH	33 nH	22 nH	18 nH	15 nH

### Recommended Bias Resistor Values for I<sub>D</sub>=80mA

$$R_{BIAS} = (V_S - V_D) / I_D$$

Supply Voltage(V <sub>S</sub> )	8 V	9 V	10 V	12 V
R <sub>BIAS</sub>	27 Ω	39 Ω	51 Ω	75 Ω

Note: R<sub>BIAS</sub> provides DC bias stability over temperature.

### Mounting Instructions

1. Solder the copper pad on the backside of the device package to the ground plane.
2. Use a large ground pad area with many plated through-holes as shown.
3. We recommend 1 or 2 ounce copper. Measurement for this data sheet were made on a 31 mil thick FR-4 board with 1 ounce copper on both sides.

Pin #	Function	Description
1	RF IN	RF input pin. This pin requires the use of an external DC blocking capacitor chosen for the frequency of operation.
2, 4	GND	Connection to ground. Use via holes for best performance to reduce lead inductance as close to ground leads as possible.
3	RF OUT/BIAS	RF output and bias pin. DC voltage is present on this pin, therefore a DC blocking capacitor is necessary for proper operation.

### Part Number Ordering Information

Part Number	Reel Size	Devices/Reel
NGA-689	7"	1000

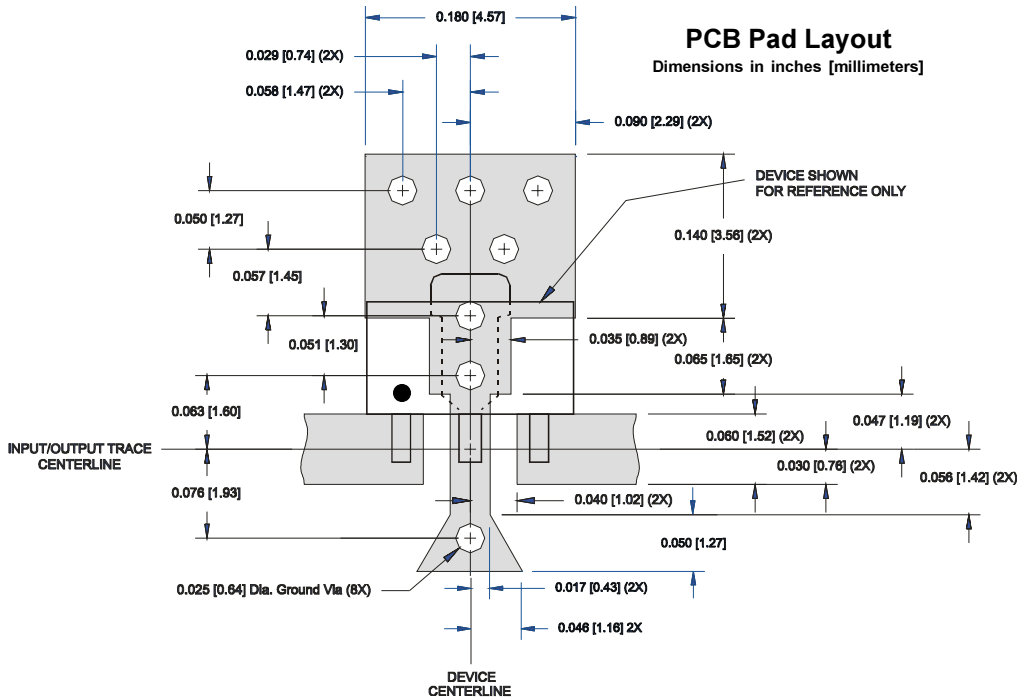

### Nominal Package Dimensions

Dimensions in inches [millimeters]

Refer to package drawing posted at [www.sirenza.com](http://www.sirenza.com) for tolerances.

