

## WIDE BAND AGC AMPLIFIER GaAs MMIC

### ■GENERAL DESCRIPTION

NJG1101F is a GaAs MMIC designed mainly for wireless phone handsets at frequency range of 850MHz from 2.5GHz.  
 NJG1101F is a variable gain amplifier with 40 dB dynamic range and exhibits low current consumption.  
 MTP6 package is adopted.

### ■PACKAGE OUTLINE

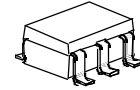

NJG1101F

### ■FEATURES

- Single and low voltage operation
- Low current consumption
- Small signal gain
  
- Wide gain control range
- Pout at 1dB gain compression point
- Package

$V_{DD}=+3.0V$  typ.  
 $I_{DD}=10mA$  typ.  
 18dB typ. @ $f=1.5GHz$   
 ( $f=0.85\sim 2.5GHz$  @3dB down)  
 40dB typ. @ $V_{CONT}=+0.1\sim +2.0V$   
 $+1.5dBm$  typ. @ $f=1.5GHz$   
 MTP6 (Mount Size: 2.8 x 2.9 x 1.2mm)

### ■PIN CONFIGURATION

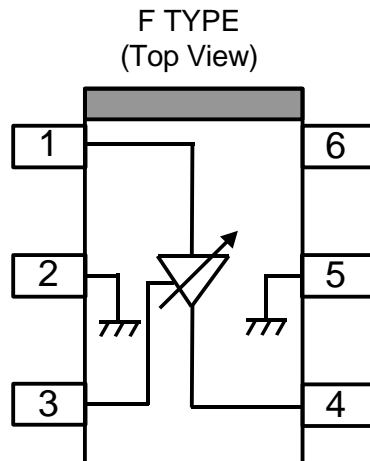

- Pin connection
1.  $RF_{in}$
  2. GND
  3.  $V_{CONT}$
  4.  $RF_{out}$  &  $V_{DD}$
  5. GND
  6.  $V_{DD}$

Note: is a package orientation mark.

# NJG1101F

## ■ABSOLUTE MAXIMUM RATINGS

( $T_a=+25^{\circ}\text{C}$ ,  $Z_s=Z_l=50\Omega$ )

PARAMETER	SYMBOL	CONDITIONS	RATINGS	UNITS
Drain Voltage	$V_{DD}$		6	V
Gain Control Voltage	$V_{CONT}$	$V_{DD}=3V$	3	V
Input Power	$P_{in}$	$V_{DD}=3V$ , $V_{CONT}=2V$	10	dBm
Power Dissipation	$P_D$		300	mW
Operating Temperature	$T_{opr}$		-40~+85	$^{\circ}\text{C}$
Storage Temperature	$T_{stg}$		-55~+150	$^{\circ}\text{C}$

## ■ELECTRICAL CHARACTERISTICS1 (Wide band: Measured at TEST CIRCUIT 1)

( $T_a=25^{\circ}\text{C}$ ,  $Z_s=Z_l=50\Omega$ )

PARAMETER	SYMBOL	CONDITIONS	MIN	TYP	MAX	UNITS
Operating Frequency	freq	$V_{DD}=3.0V$	0.85	1.5	2.5	GHz
Drain Voltage	$V_{DD}$		2.7	3.0	5.0	V
Operating Current	$I_{DD}$	$V_{DD}=3.0V$ , $V_{CONT}=2V$ , $P_{out}=-10\text{dBm}$	-	10	13	mA
Small Signal Gain	Gain	$V_{DD}=3.0V$ , $V_{CONT}=2V$ , $P_{out}=-10\text{dBm}$ , $f=1.5\text{GHz}$	15.5	18	21	dB
Gain Flatness	$G_{flat}$	$V_{DD}=3.0V$ , $V_{CONT}=2V$ , $P_{in}=-25\text{dBm}$ $f=0.85\sim 2.5\text{GHz}$	-	3	-	dB
Gain Control Range	$G_{cont}$	$V_{DD}=3.0V$ , $V_{CONT}=0.1\sim 2.0V$ , $P_{in}=-25\text{dBm}$ , $f=1.5\text{GHz}$	35	40	-	dB
Pout at 1dB Gain Compression point	$P_{-1dB}$	$V_{DD}=3.0V$ , $V_{CONT}=2V$ , $f=1.5\text{GHz}$	-	+1.5	-	dBm
Adjacent Channel Leakage Power (PDC Regulation)	$P_{acp}$	$V_{DD}=3.0V$ , $V_{CONT}=2V$ , $P_{out}=-10\text{dBm}$ , $f=1.5\text{GHz}$ Offset=50kHz, $P_{in}$ ; $\pi/4$ DQPSK	-	-68	-	dBc

## ■ ELECTRICAL CHARACTERISTICS 2 (800MHz Band: Measured at TEST CIRCUIT 2)

(T<sub>a</sub>=25°C, Z<sub>s</sub>=Z<sub>i</sub>=50Ω)

PARAMETER	SYMBOL	CONDITIONS	MIN	TYP	MAX	UNITS
Operating Frequency	freq	V <sub>DD</sub> =3.0V	850	938	960	MHz
Drain Voltage	V <sub>DD</sub>		2.7	3.0	5.0	V
Operating Current	I <sub>DD</sub>	V <sub>DD</sub> =3.0V, V <sub>CONT</sub> =2V, P <sub>out</sub> =-10dBm	-	10	13	mA
Small Signal Gain	Gain	V <sub>DD</sub> =3.0V, V <sub>CONT</sub> =2V, P <sub>out</sub> =-10dBm, f=1.5GHz	15.5	18	21	dB
Gain Flatness	G <sub>flat</sub>	V <sub>DD</sub> =3.0V, V <sub>CONT</sub> =2V, P <sub>in</sub> =-25dBm, f=0.85~2.5GHz	-	0.5	-	dB
Gain Control Range	G <sub>cont</sub>	V <sub>DD</sub> =3.0V, V <sub>CONT</sub> =0.1~2.0V, P <sub>in</sub> =-25dBm, f=1.5GHz	35	40	-	dB
Pout at 1dB Gain Compression point	P <sub>-1dB</sub>	V <sub>DD</sub> =3.0V, V <sub>CONT</sub> =2V, f=1.5GHz	-	+1.5	-	dBm
Adjacent Channel Leakage Power (PDC Regulation)	P <sub>acp</sub>	V <sub>DD</sub> =3.0V, V <sub>CONT</sub> =2V, P <sub>out</sub> =-10dBm, f=1.5GHz offset=50kHz, P <sub>in</sub> ; π/4 DQPSK	-	-68	-	dBc
Input VSWR	VSWR <sub>i</sub>	V <sub>DD</sub> =3.0V, V <sub>CONT</sub> =2V, f=1.5GHz	-	1.8	-	
Output VSWR	VSWR <sub>o</sub>	V <sub>DD</sub> =3.0V, V <sub>CONT</sub> =2V, f=1.5GHz	-	1.5	-	

# NJG1101F

## ■ ELECTRICAL CHARACTERISTICS 3 (PDC1.5GHz/PHS1.9GH: Measured at TEST CIRCUIT 2)

( $T_a=25^\circ\text{C}$ ,  $Z_s=Z_i=50\Omega$ )

PARAMETER	SYMBOL	CONDITIONS	MIN	TYP	MAX	UNITS
Operating Frequency 1	freq1	$V_{DD}=3.0\text{V}$	1429	1441	1453	MHz
Operating Frequency 2	freq2	$V_{DD}=3.0\text{V}$	1800	1900	1920	MHz
Drain Voltage	$V_{DD}$		2.7	3.0	5.0	V
Operating Current	$I_{DD}$	$V_{DD}=3.0\text{V}$ , $V_{CONT}=2\text{V}$ , $P_{out}=-10\text{dBm}$	-	10	13	mA
Small Signal Gain	Gain	$V_{DD}=3.0\text{V}$ , $V_{CONT}=2\text{V}$ , $P_{out}=-10\text{dBm}$ , $f=1.5\text{GHz}$	15.5	18	21	dB
Gain Flatness 1	$G_{flat1}$	$V_{DD}=3.0\text{V}$ , $V_{CONT}=2\text{V}$ , $P_{in}=-25\text{dBm}$ , $f=1429\sim 1453\text{MHz}$	-	0.5	-	dB
Gain Flatness 2	$G_{flat2}$	$V_{DD}=3.0\text{V}$ , $V_{CONT}=2\text{V}$ , $P_{in}=-25\text{dBm}$ , $f=1800\sim 1920\text{MHz}$	-	0.5	-	dB
Gain Control Range	$G_{cont}$	$V_{DD}=3.0\text{V}$ , $V_{CONT}=0.1\sim 2.0\text{V}$ , $P_{in}=-25\text{dBm}$	35	40	-	dB
Pout at 1dB Gain Compression point 1	$P_{-1dB1}$	$V_{DD}=3.0\text{V}$ , $V_{CONT}=2\text{V}$ , $f=1429\sim 1453\text{MHz}$	-	+1.5	-	dBm
Pout at 1dB Gain Compression point 2	$P_{-1dB2}$	$V_{DD}=3.0\text{V}$ , $V_{CONT}=2\text{V}$ , $f=1800\sim 1920\text{MHz}$	-	+1.0	-	dBm
Adjacent Channel Leakage Power 1 (PDC Regulation)	$P_{acp1}$	$V_{DD}=3.0\text{V}$ , $V_{CONT}=2\text{V}$ , $P_{out}=-10\text{dBm}$ , $f=1441\text{MHz}$ offset=50kHz, $P_{in}; \pi/4$ DQPSK	-	-68	-	dBc
Adjacent Channel Leakage Power 2 (PDC Regulation)	$P_{acp2}$	$V_{DD}=3.0\text{V}$ , $V_{CONT}=2\text{V}$ , $P_{out}=-10\text{dBm}$ , $f=1900\text{MHz}$ offset=50kHz, $P_{in}; \pi/4$ DQPSK	-	-70	-	dBc
Input VSWR	$VSWR_i$	$V_{DD}=3.0\text{V}$ , $V_{CONT}=2\text{V}$	-	1.8	-	
Output VSWR	$VSWR_o$	$V_{DD}=3.0\text{V}$ , $V_{CONT}=2\text{V}$	-	1.5	-	

## ■ TYPICAL CHARACTERISTICS 1 (Wide Band: Measured on TEST CIRCUIT 1)

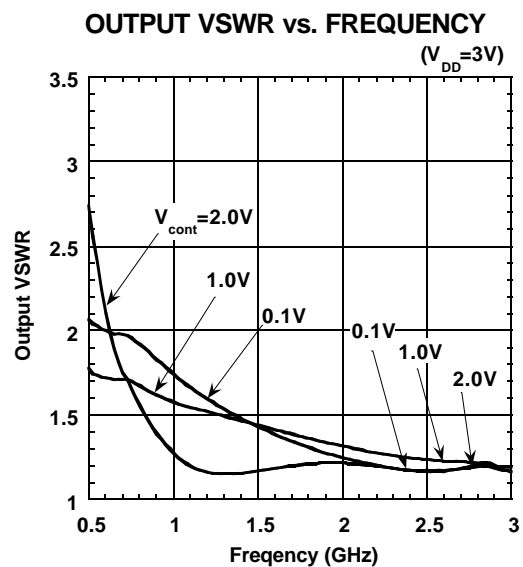
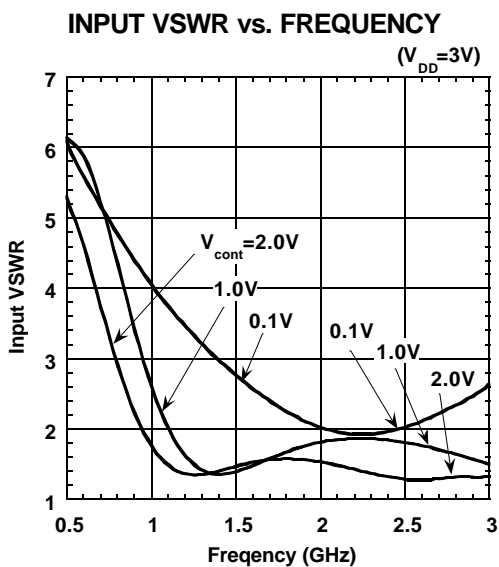
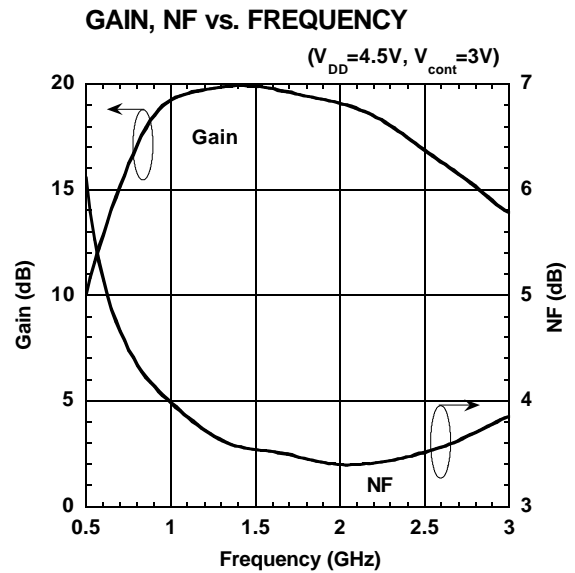
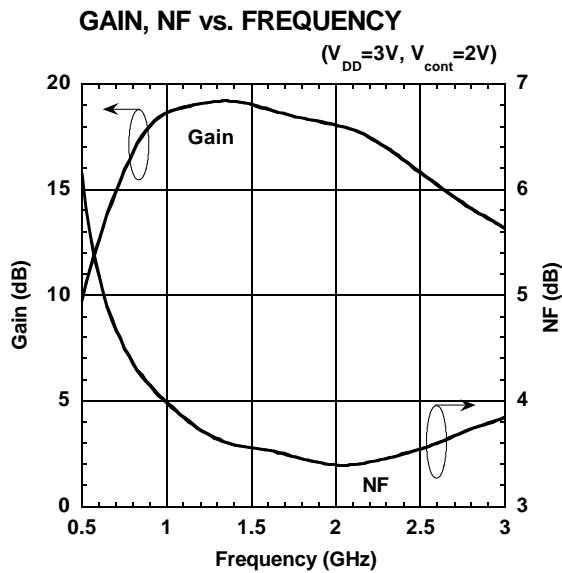
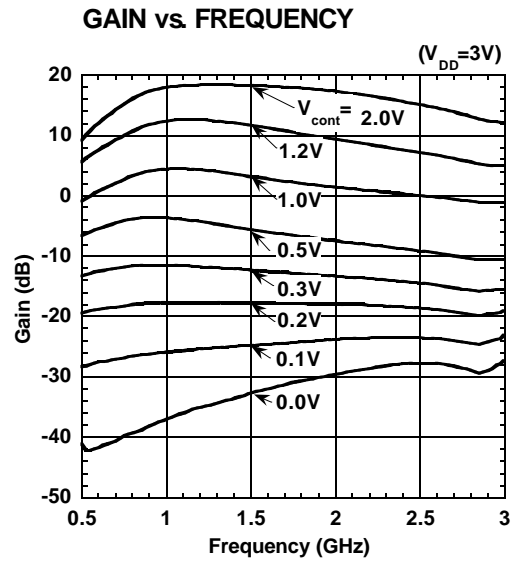
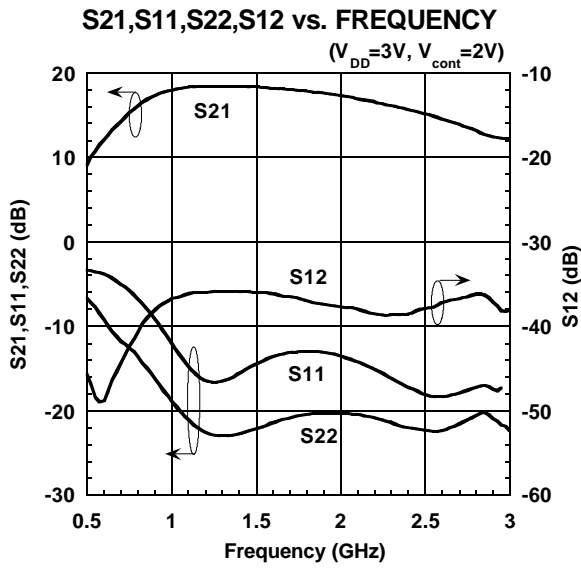

# NJG1101F

## TYPICAL CHARACTERISTICS 1 (Wide Band: Measured on TEST CIRCUIT 1)

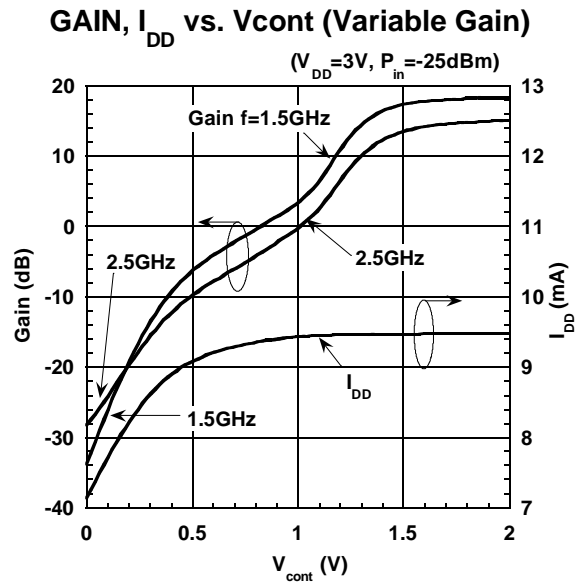
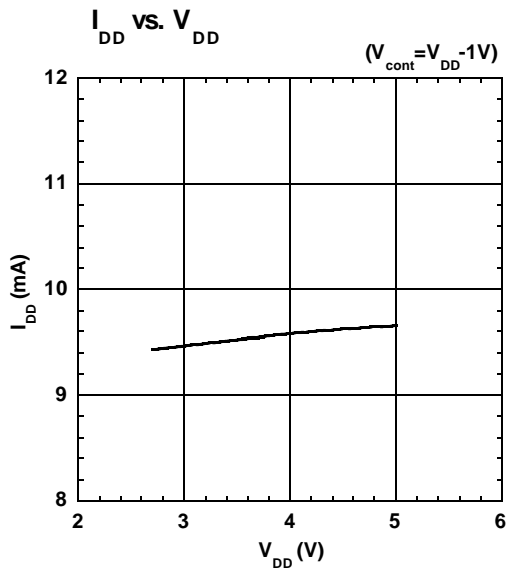

**OUTPUT POWER,  $I_{DD}$  vs. INPUT POWER**

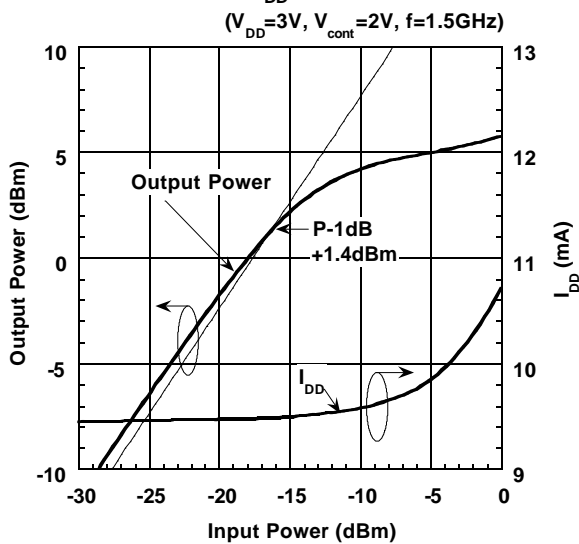

**OUTPUT POWER,  $I_{DD}$  vs. INPUT POWER**

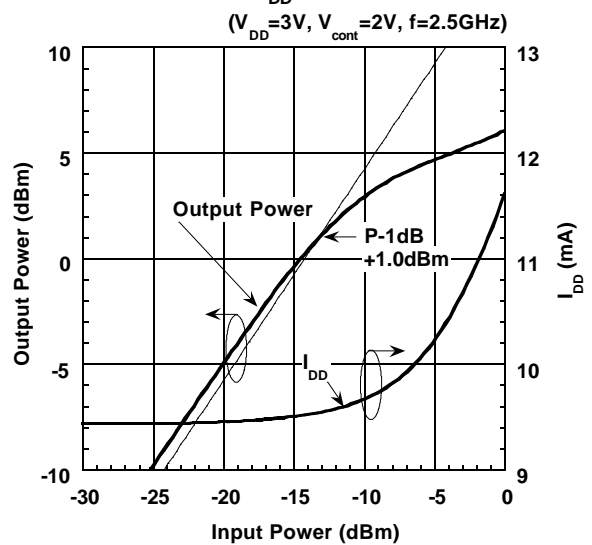

**GAIN vs.  $V_{cont}$**

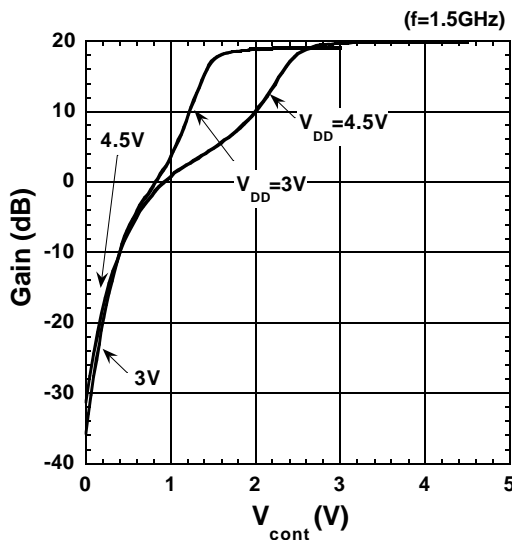

**GAIN vs.  $V_{cont}$**

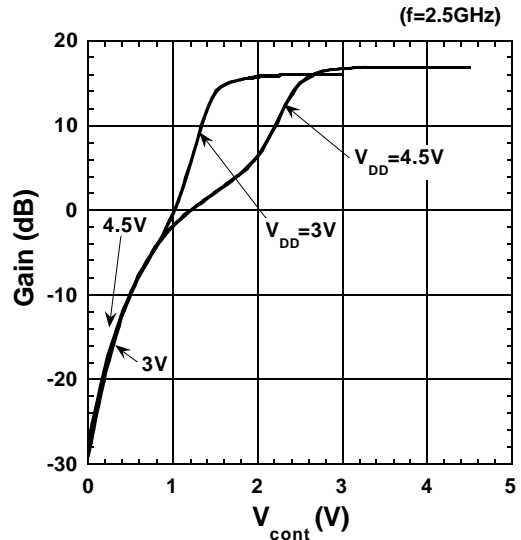

## TYPICAL CHARACTERISTICS 1 (Wide Band: Measured on TEST CIRCUIT 1)

### $I_{DD}$ , $I_{cont}$ vs. TEMPERATURE

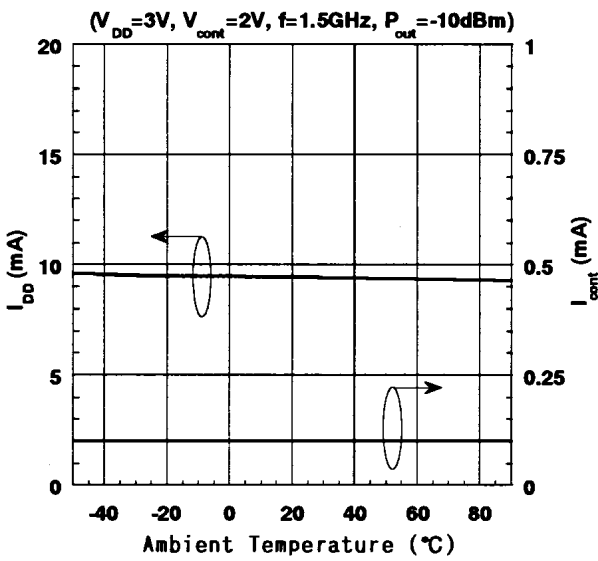

### ACP vs. TEMPERATURE

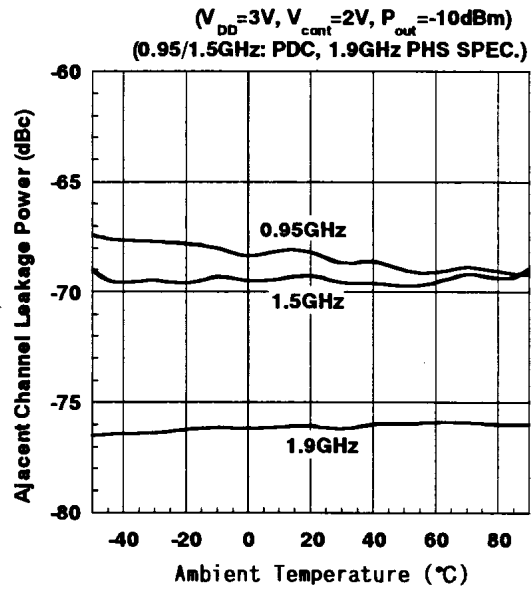

### GAIN vs. TEMPERATURE

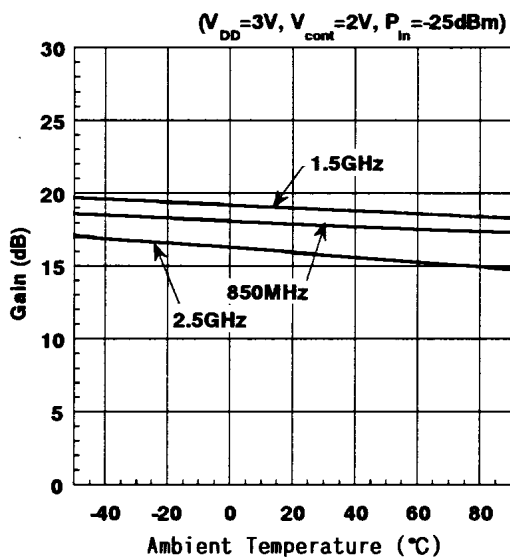

### INPUT RETURN LOSS vs. TEMPERATURE

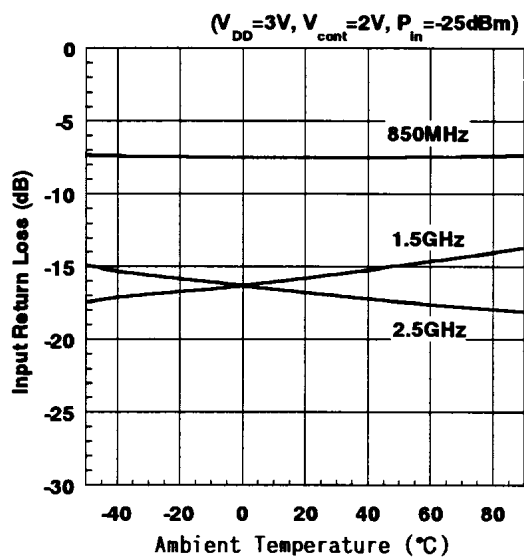

### OUTPUT RETURN LOSS vs. TEMPERATURE

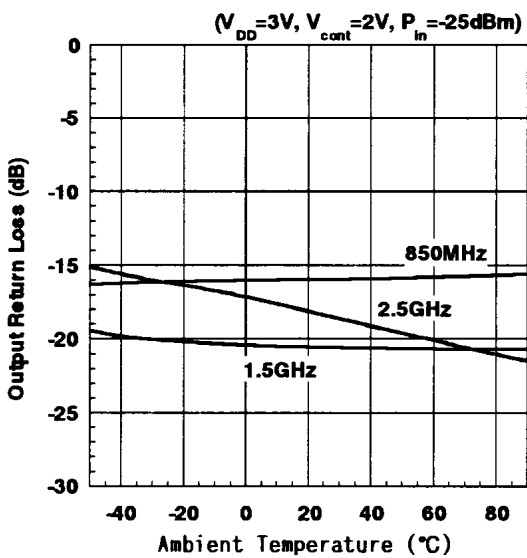

### ISOLATION vs. TEMPERATURE

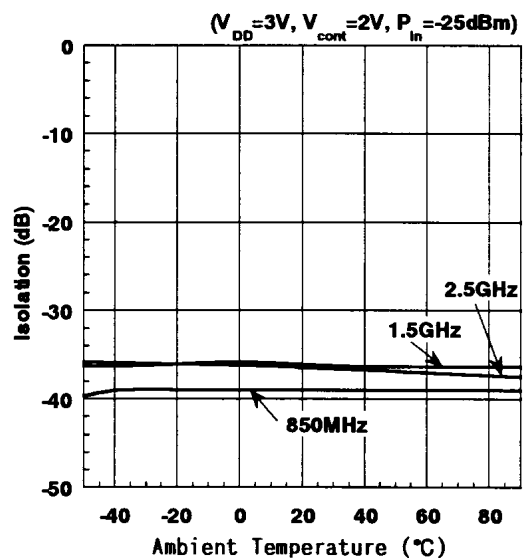

# NJG1101F

## TYPICAL CHARACTERISTICS 2 (PDC 800MHz Band: Measured on TEST CIRCUIT 2)

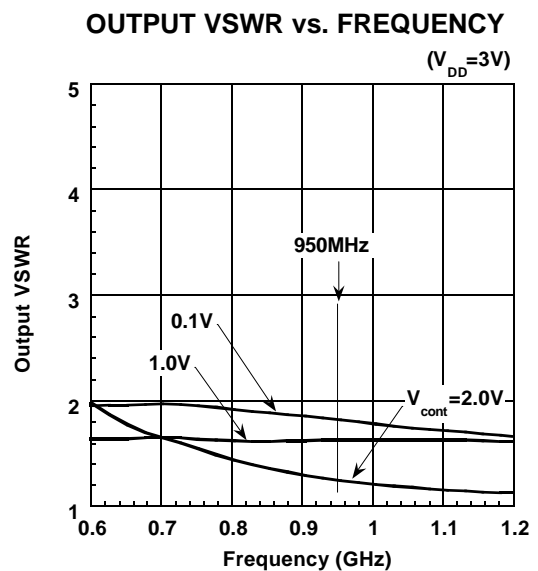
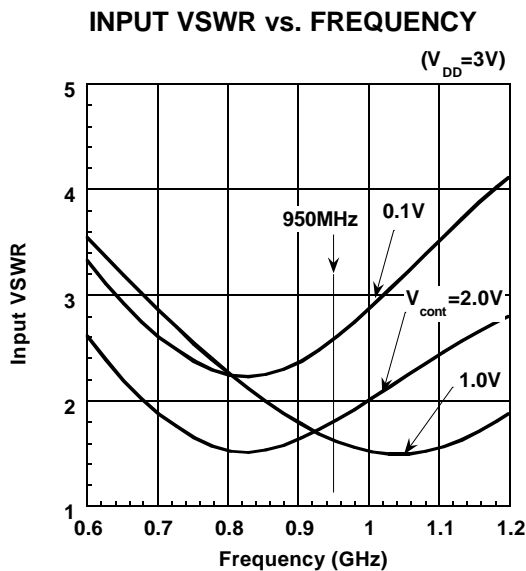
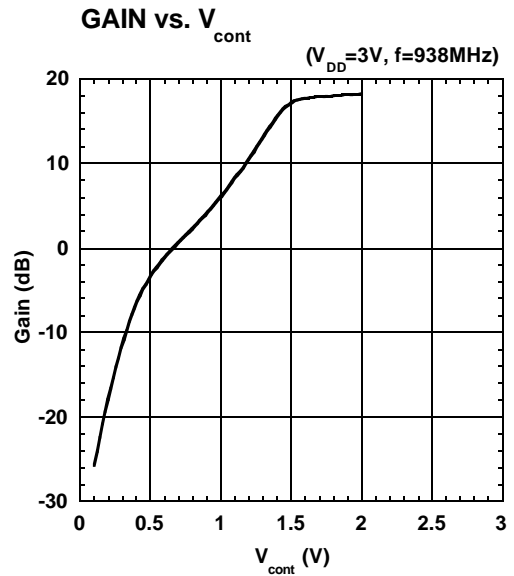
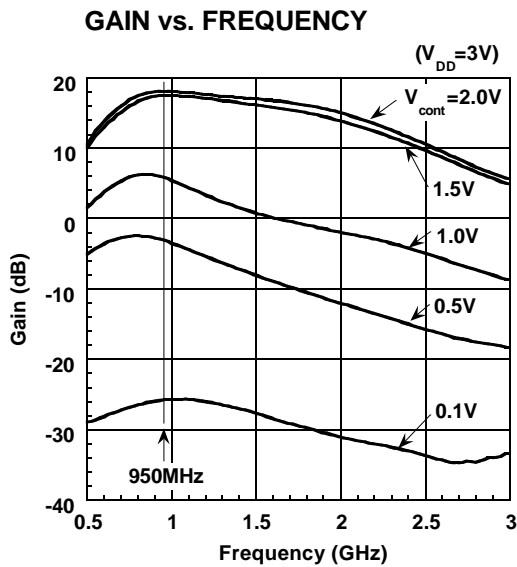

**OUTPUT POWER,  $I_{DD}$  vs. INPUT POWER**

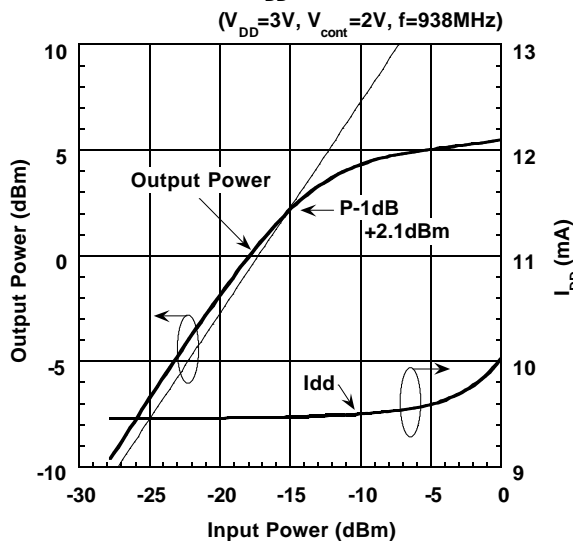

**ACP, RMS VECTOR ERROR vs. OUTPUT POWER**

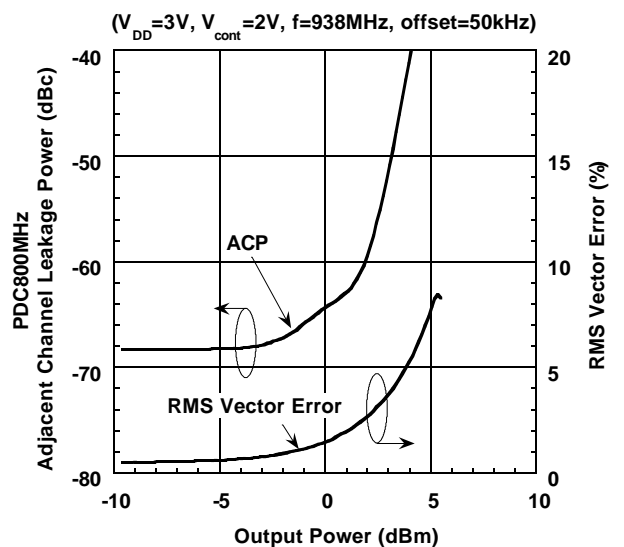



## ■ TYPICAL CHARACTERISTICS 2 (PDC 800MHz Band: Measured on TEST CIRCUIT 2)

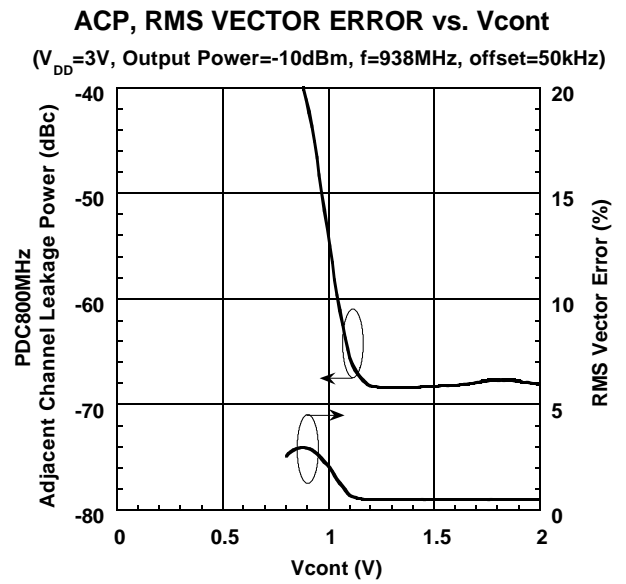
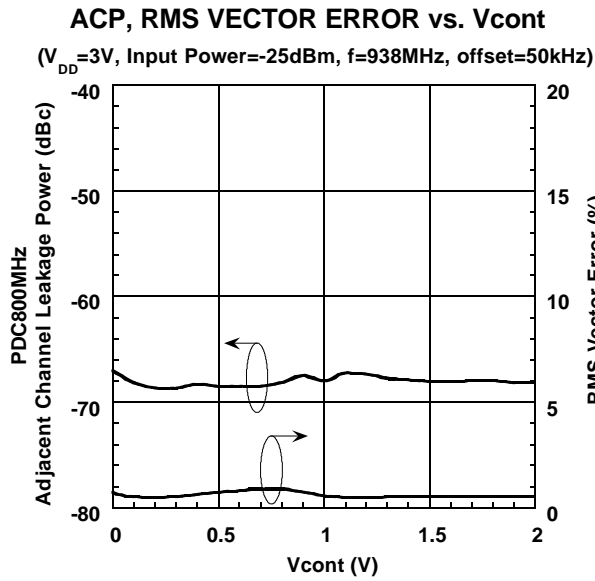

## ■ TYPICAL CHARACTERISTICS 3 (PDC1.5GHz/PHS1.9GHz Band : Measured on TEST CIRCUIT 2)

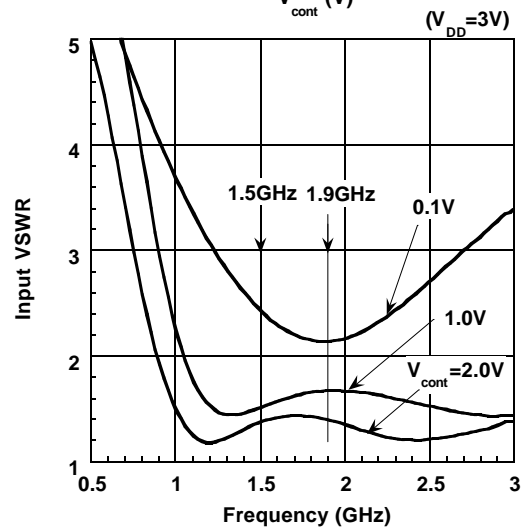
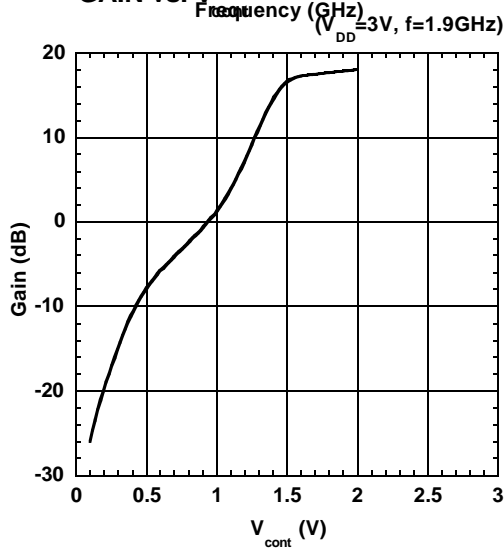
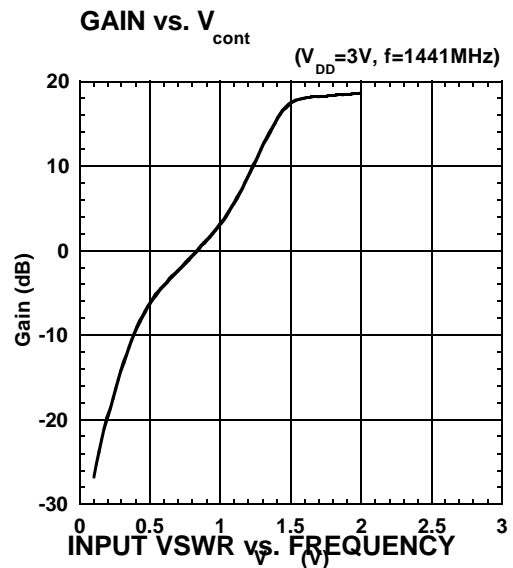
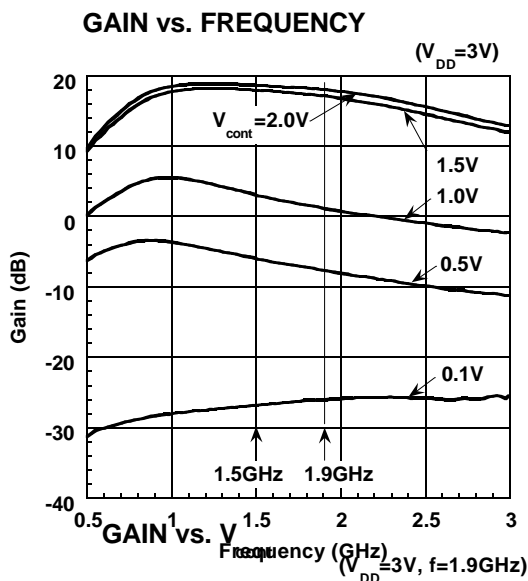

# NJG1101F

## ■ TYPICAL CHARACTERISTICS 3 (PDC1.5GHz/PHS1.9GHz Band: Measured on TEST CIRCUIT 2)

OUTPUT VSWR vs. FREQUENCY

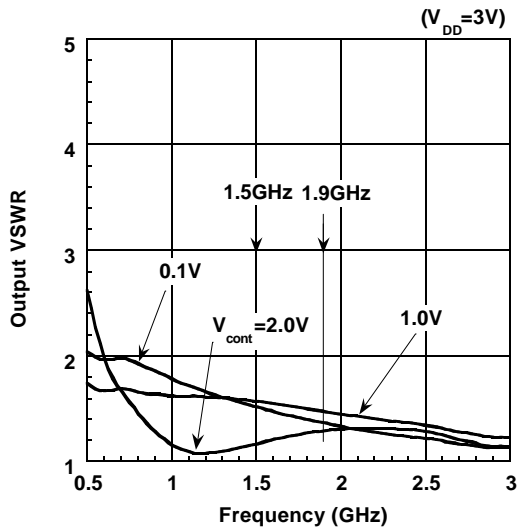

OUTPUT POWER,  $I_{DD}$  vs. INPUT POWER

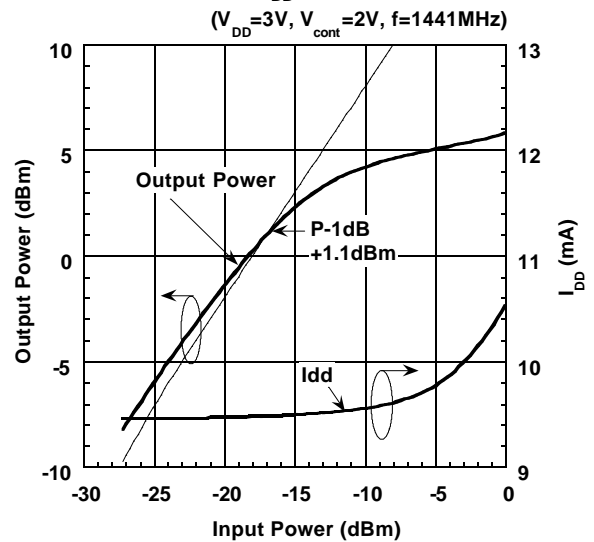

OUTPUT POWER,  $I_{DD}$  vs. INPUT POWER

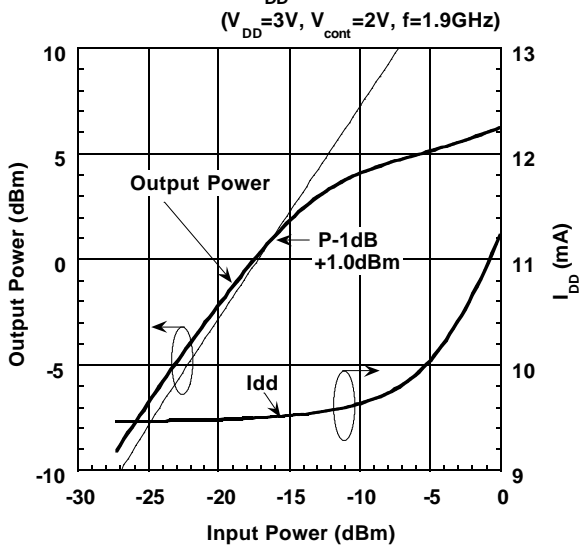

ACP, RMS VECTOR ERROR vs. OUTPUT POWER

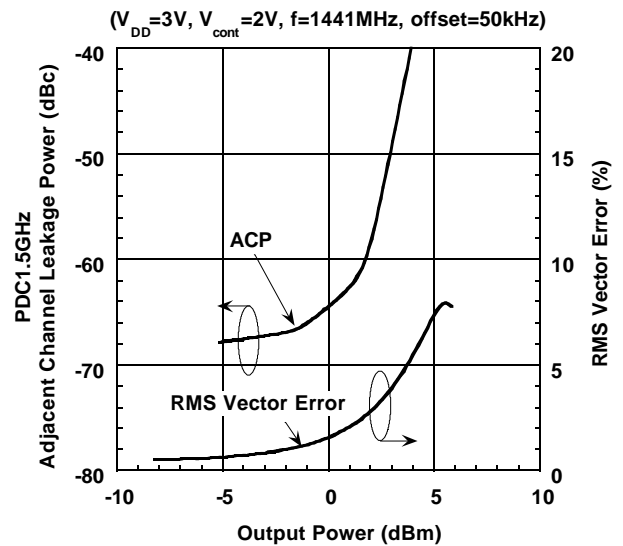

ACP, RMS VECTOR ERROR vs. OUTPUT POWER

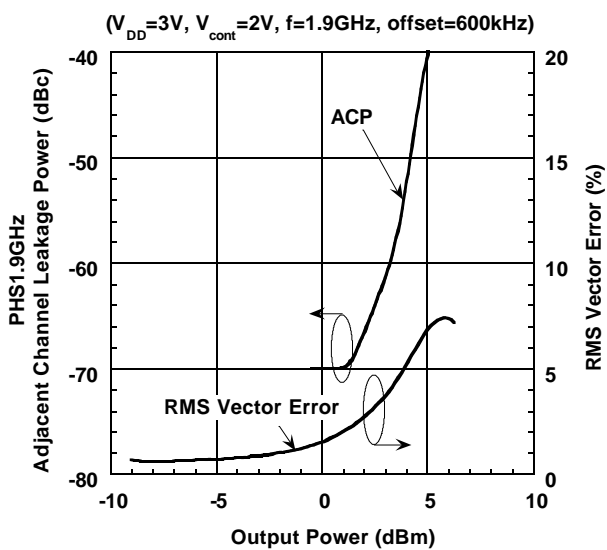

ACP, RMS VECTOR ERROR vs.  $V_{cont}$

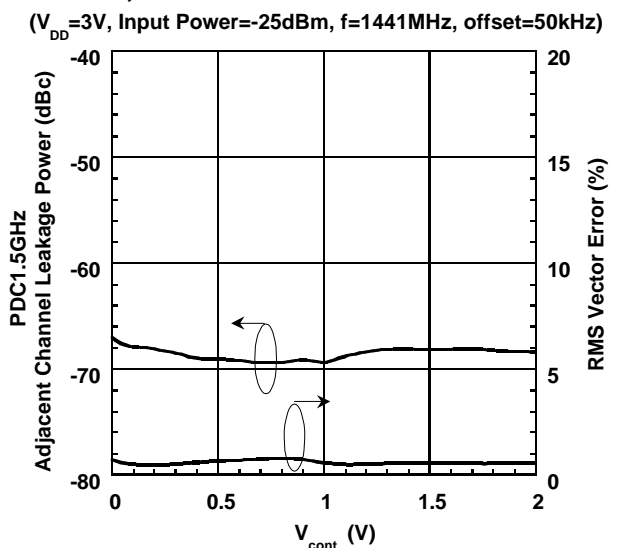

## ■ TYPICAL CHARACTERISTICS 3 (PDC1.5GHz/PHS1.9GHz Band: Measured on TEST CIRCUIT 2)

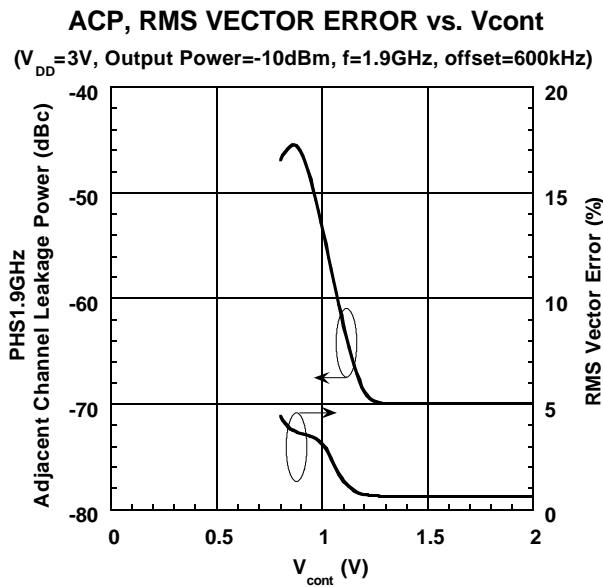
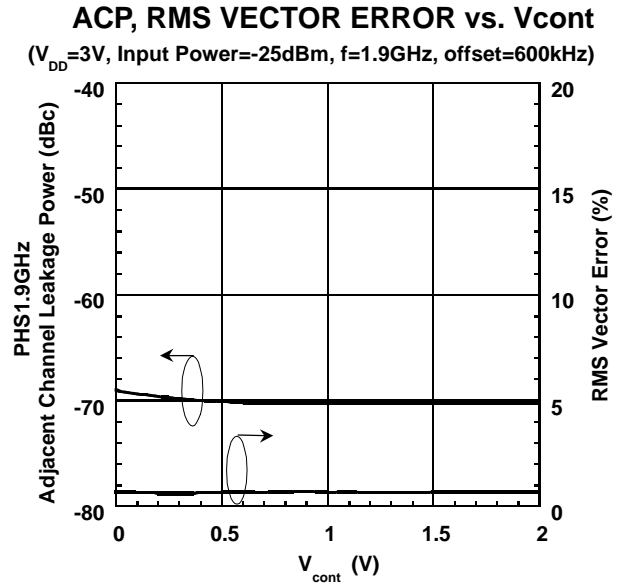
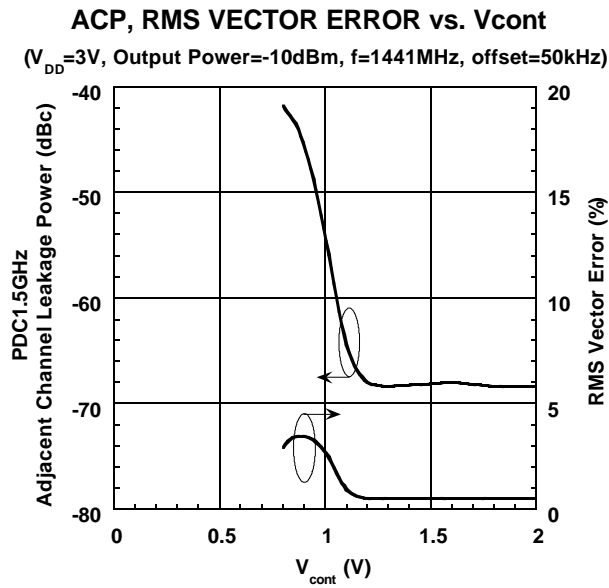

# NJG1101F

## APPLICATION CIRCUIT

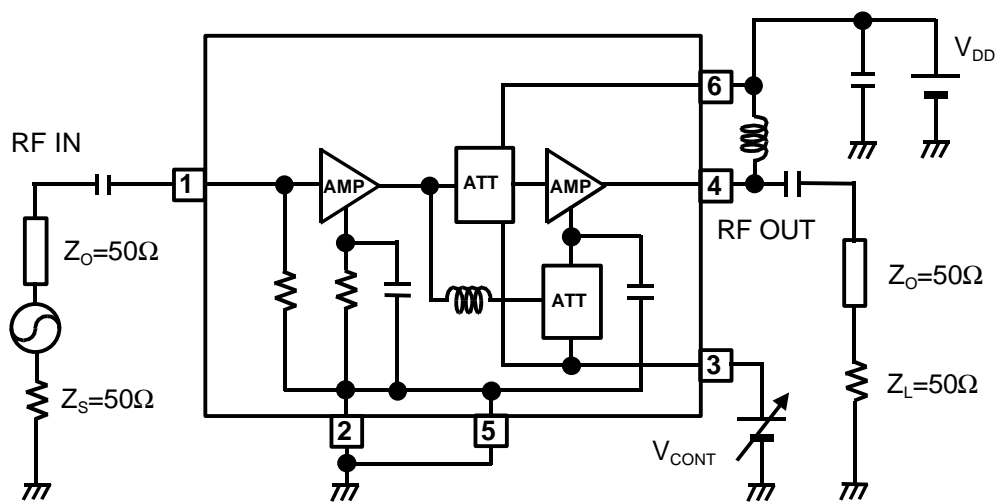

## ■TEST CIRCUIT1 (WIDE BAND)

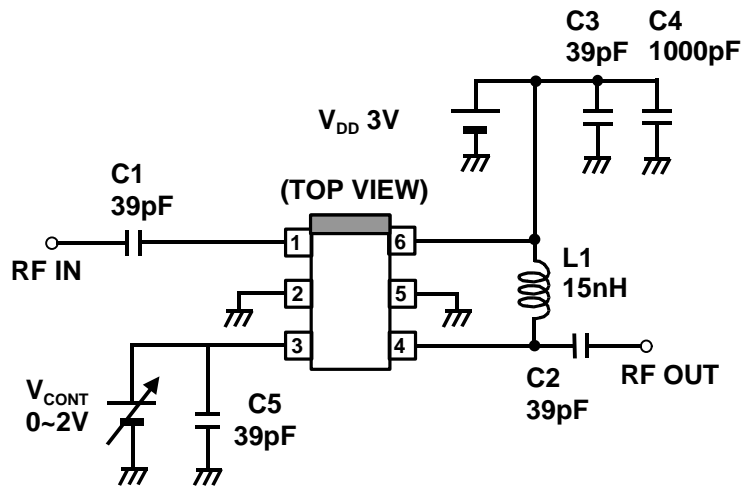

## ■TEST CIRCUIT2 (PDC 800MHz, PDC 1.5GHz, PHS 1.9GHz)

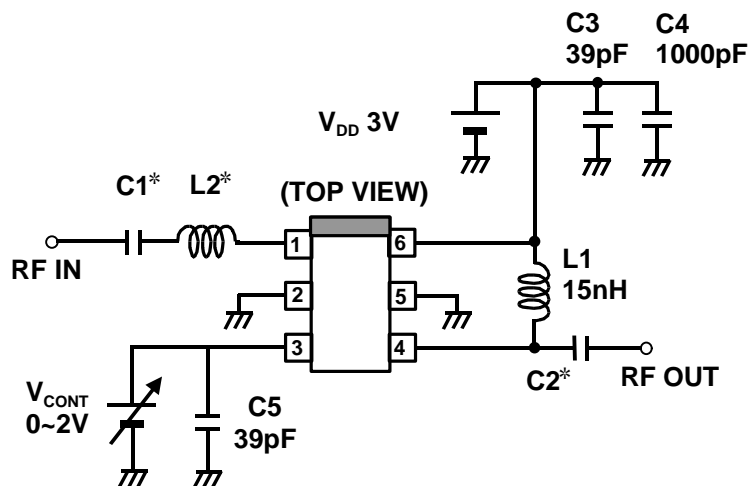

**\*NOTE**

	C1	L2	C2
PDC800MHz	100pF	10nH	100pF
PDC1.5GHz/PHS1.9GHz	10pF	1.5nH	10pF

# NJG1101F

## RECOMMENDED PCB DESIGN

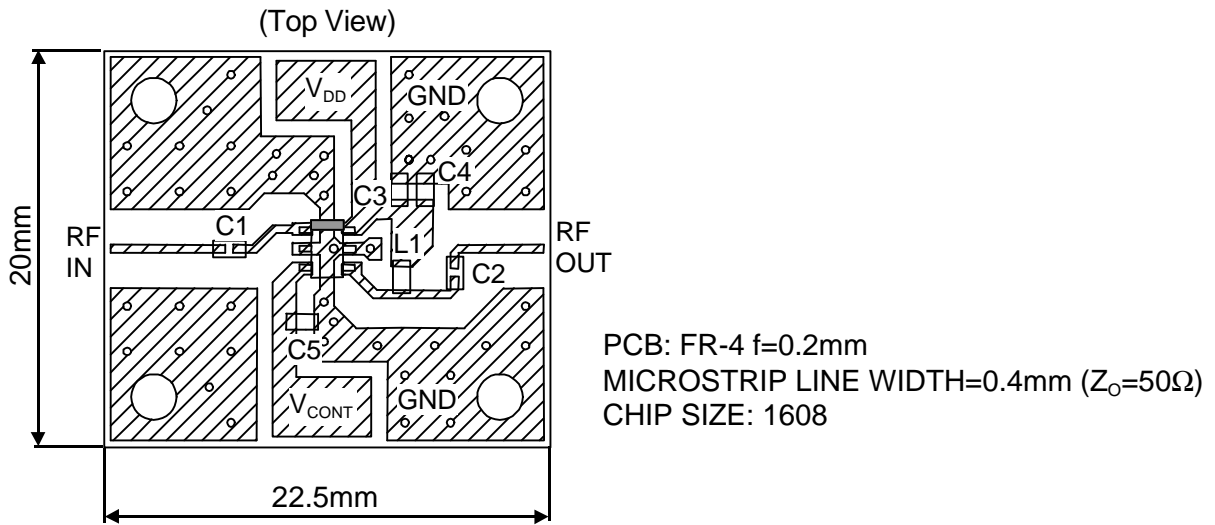

### Notes:

[1]Following chip capacitors work as bypass capacitor, and should be connected to corresponding terminals and the ground plane as close as possible.

①C3

②C4

③C5

[2]Following chip capacitors are necessary to block DC bias.

①C1

②C2

[3]Parts list

Parts ID	Comment
C1~C5	MURATA GRM36 Series
L1~L2	TAIYO-YUDEN HK1608 Series

## ■PACKAGE OUTLINE (MTP6)

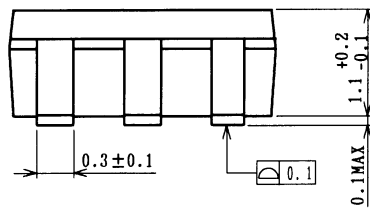
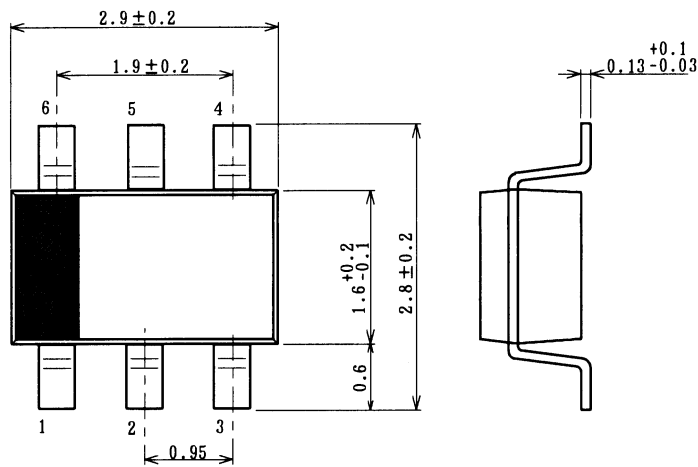

Lead material	: Copper
Lead surface finish	: Solder plating
Molding material	: Epoxy resin
UNIT	: mm
Weight	: 14mg

### Cautions on using this product

This product contains Gallium-Arsenide (GaAs) which is a harmful material.

- Do NOT eat or put into mouth.
- Do NOT dispose in fire or break up this product.
- Do NOT chemically make gas or powder with this product.
- To waste this product, please obey the relating law of your country.

### [CAUTION]

The specifications on this databook are only given for information, without any guarantee as regards either mistakes or omissions. The application circuits in this databook are described only to show representative usages of the product and not intended for the guarantee or permission of any right including the industrial rights.

This product may be damaged with electric static discharge (ESD) or spike voltage. Please handle with care to avoid these damages.