

INFRARED REMOTE CONTROL RECEIVER

■ GENERAL DESCRIPTION

The NJL70H/V000A series are small and high performance receiving devices for infrared remote control system.

They can operate under low and wide supply voltage (2.4V to 5.4V). Also, their supply current is low comparing to the NJL60H/V000A and NJL80H/V000A.

The features, low and wide supply voltage, low supply current are suitable for battery operated items.

■ FEATURES

1. Wide and low supply voltage 2.4V to 5.5V
2. Low supply current 0.6mA max.
3. Mold type and metal case type to meet the design of front panel.
4. Line-up for various center carrier frequencies.

■ APPLICATIONS

1. AV instruments such as Audio, TV, VCR, CD, MD etc.
2. Home application such as Air-conditioner, Fan etc.
3. Battery operated instruments such as Toy, Camera etc.

■ LINE-UP

Mold/Metal case		Mold type		Metal Case type		
View		Top	Side	Top		
Height		5.4mm	6.3mm	8mm	11mm	15mm
Carrier Frequency	fo=					
36	kHz	NJL71H360A	NJL71V360A	NJL72H360A	NJL73H360A	NJL74H360A
36.7	kHz	NJL71H367A	NJL71V367A	NJL72H367A	NJL73H367A	NJL74H367A
38	kHz	NJL71H380A	NJL71V380A	NJL72H380A	NJL73H380A	NJL74H380A
40	kHz	NJL71H400A	NJL71V400A	NJL72H400A	NJL73H400A	NJL74H400A

Regarding other frequency or packages, please contact to New JRC individually.

■ BLOCK DIAGRAM

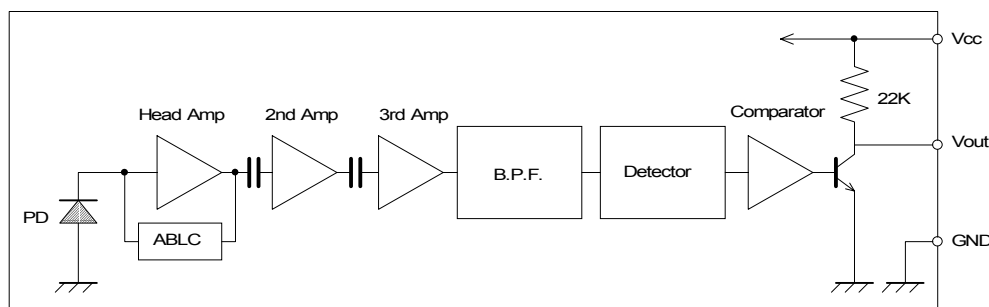

■ ABSOLUTE MAXIMUM RATINGS (Ta=25°C)

PARAMETER	SYMBOL	RATINGS	UNIT
Supply Voltage	Vcc	6.3	V
Operating Temperature Range	Topr	-20 to +75	°C
Storage Temperature Range	Tstg	-40 to +85	°C
Soldering Temperature	Tsol	260 (5sec. 4.0mm from mold body)	°C

NJL71H/71V/72H/73H/74H000A

RECOMMENDED OPERATING CONDITION

Supply Voltage Range V_{cc} 2.4 V to 5.5V

ELECTRO-OPTICAL CHARACTERISTICS ($V_{cc}=3.3V, T_a=25^\circ C$)

PARAMETER	SYMBOL	TEST CONDITION	MIN	TYP	MAX	UNIT
Supply Current	I_{cc}	No Signal Input	—	0.43	0.6	mA
Transmission Distance	L_c	Direction of Ray Axis *1	13	18	—	m
Directivity	θ_L	Angle of half L_c , Horizontal *2	—	45	—	deg
	θ_V	Angle of half L_c , Vertical *2	—	30	—	deg
Output Voltage Low	V_L	No Load	—	0.2	0.5	V
Output Voltage High	V_H	No Load	2.8	—	—	V
Low Level Pulse Width	T_{wL}	See Test Circuit	350	—	800	μs
High Level Pulse Width	T_{wH}	See Test Circuit	400	—	850	μs
Center Frequency	f_o	See Line-up	36.0	—	40.0	kHz

Note *1: Test with each center carrier frequency under the test condition shown below.

*2: Place major axis of elliptic lens in horizontal direction and minor vertical.

TEST METHOD

Test condition in as follows:

(1) Standard transmitter:

Transmitting waveform is shown in Fig.1
 Transmitting power should be adjusted so that output voltage V_{out} will be 400mVp-p. (Test circuit is shown in Fig.2)
 Regarding IR LED used for transmitter,
 $\lambda_p=940nm, \Delta\lambda=50nm$.

Regarding photo diode,
 Sensitivity $S=26nA/Lx$
 in case light source temperature $2856^\circ K$,
 $E_e=100Lx, V_R=5V$

(2) Test system: Shown in Fig.3.

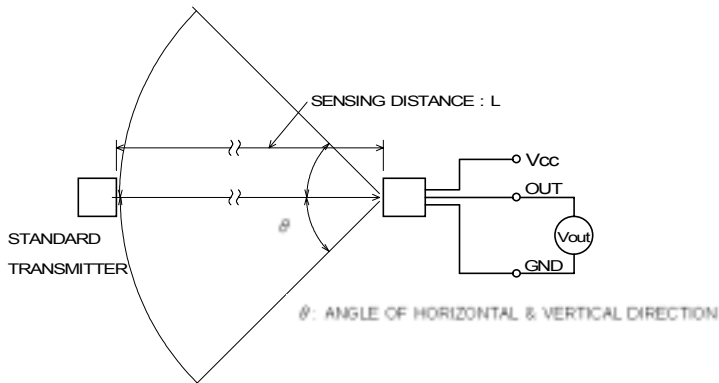

Fig.3 TEST SYSTEM

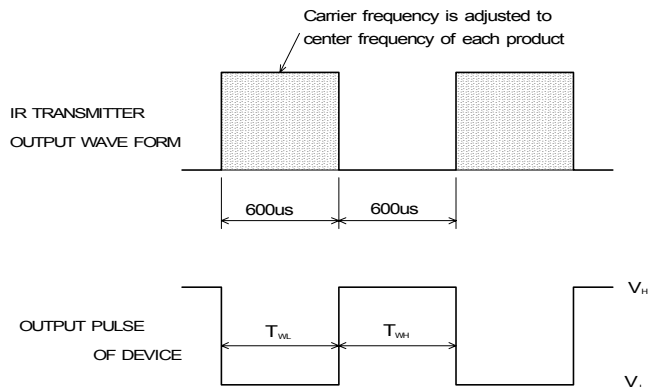

Fig.1 TRANSMITTER WAVE FORM

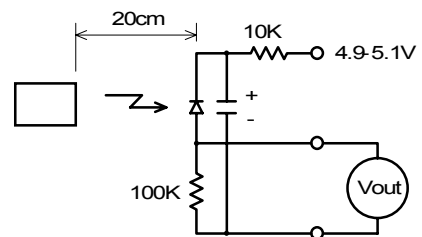
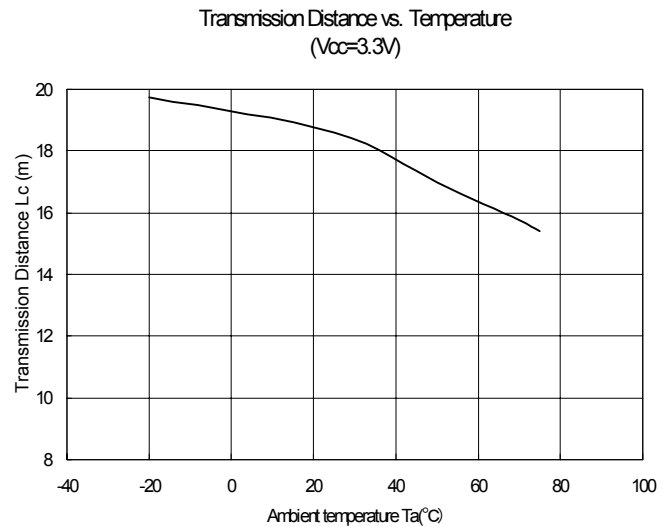
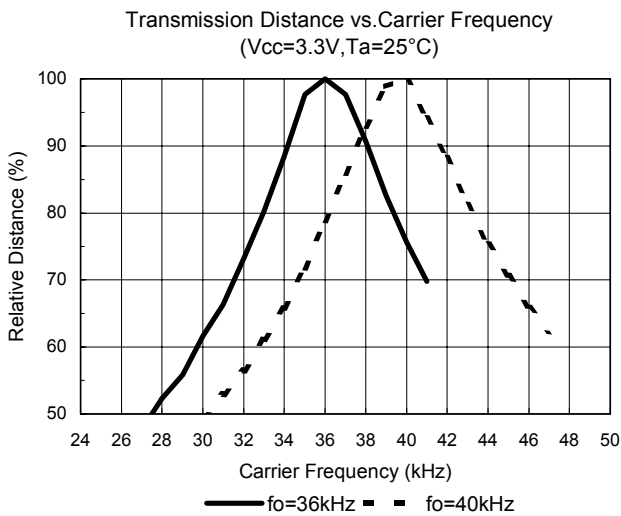
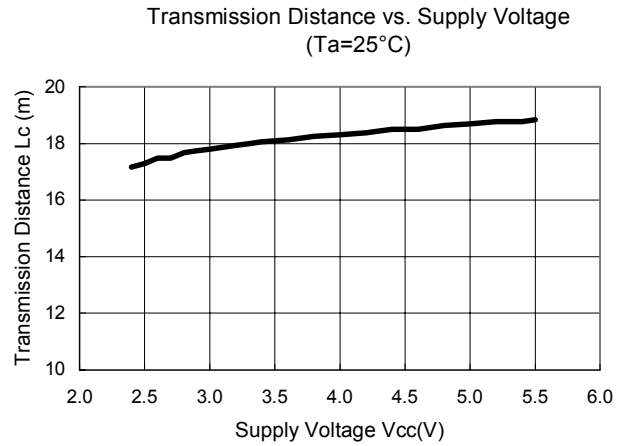
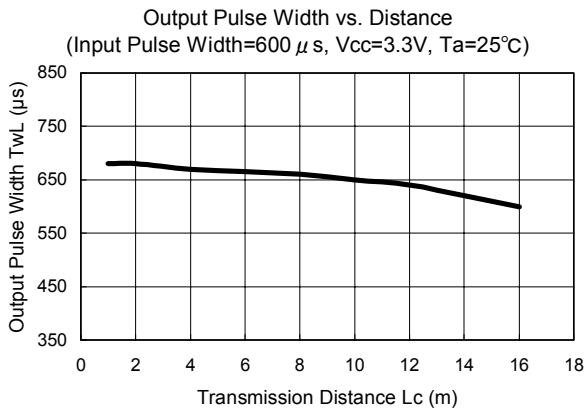
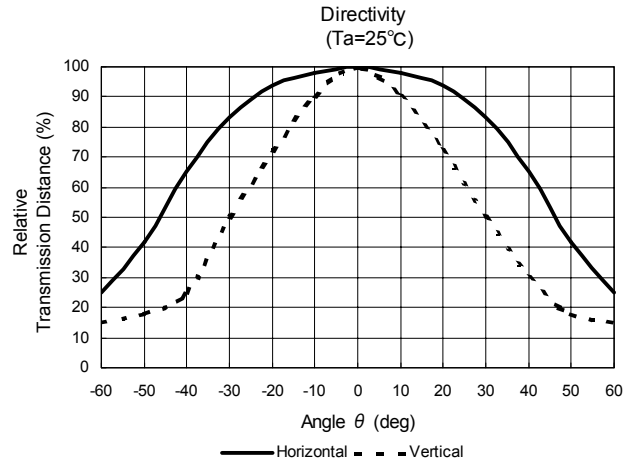
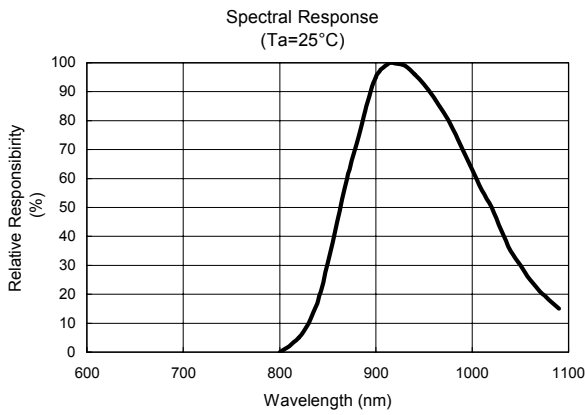

Fig.2 STD. TRANSMITTER TEST CIRCUIT

TYPICAL CHARACTERISTICS



NJL71H/71V/72H/73H/74H000A

RECOMMENDED APPLICATION CIRCUIT

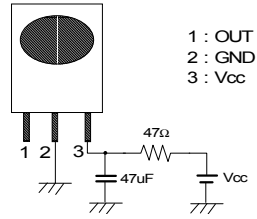

RC Filter should be connected closely between Vcc pin and GND pin.

OUTLINE

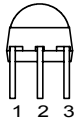
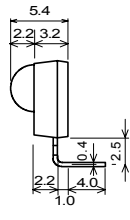
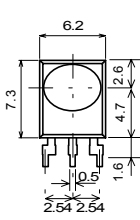

1 : OUT
2 : GND
3 : Vcc

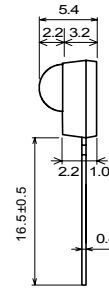
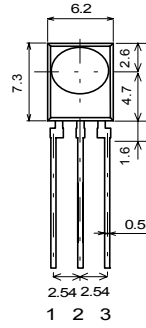

1 : OUT
2 : GND
3 : Vcc

NJL71H000A
UNIT:mm

NJL71V000A
UNIT:mm

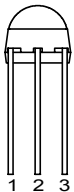
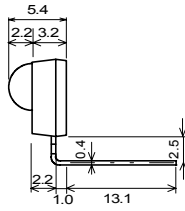
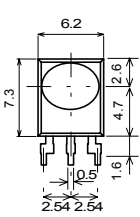

1 : OUT
2 : GND
3 : Vcc

NJL71H000AF3
UNIT:mm

NJL71H/71V/72H/73H/74H000A

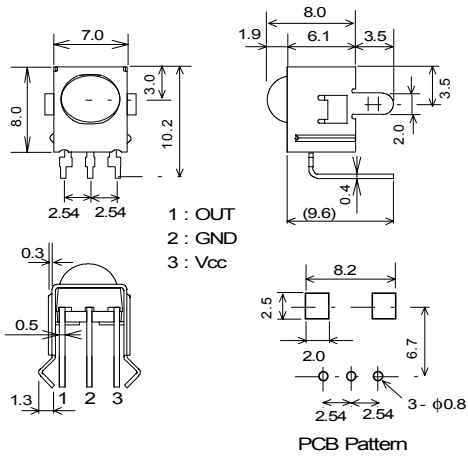

NJL72H000A
UNIT:mm

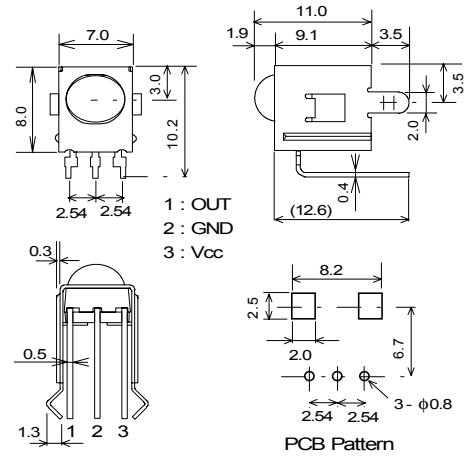

NJL73H000A
UNIT:mm

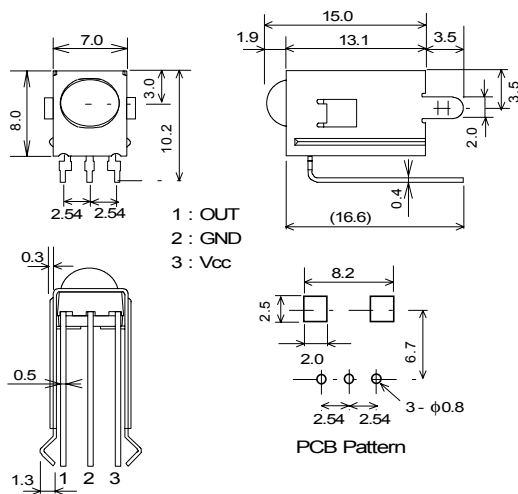

NJL74H000A
UNIT:mm

1. Tolerance is ± 0.3 mm unless otherwise noted.
2. Ground metal case on PCB. Metal case is not connected to GND pin inside. Tolerance is ± 0.3 mm unless otherwise noted.

[CAUTION]

The specifications on this databook are only given for information, without any guarantee as regards either mistakes or omissions. The application circuits in this databook are described only to show representative usages of the product and not intended for the guarantee or permission of any right including the industrial rights.