

## SINGLE SUPPLY DUAL AMPLIFIER

### ■ GENERAL DESCRIPTION

The **NJM12904** is single-supply dual operational amplifier, which can operate from 2V supply. The features are low offset voltage, low bias current, and drive TTL or DTL circuit directly. The package lineup is DIP, DMP and others compact, which is SON, so that the **NJM12904** is suitable for audio for low voltage operation and any other kind of signal amplifier.

### ■ FEATURES

- Operating Voltage (+2V to +14V)
- Input Offset Voltage (5mV max.)
- Slew Rate (0.7V/μs typ.)
- Operating Current (0.7mA typ.)
- Bipolar Technology
- Package Outline DIP8,DMP8,EMP8, SSOP8,VSP8,SIP8

### ■ PACKAGE OUTLINE

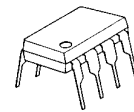

NJM12904D

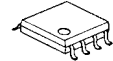

NJM12904M



NJM12904E



NJM12904V



NJM12904R

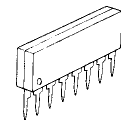

NJM12904L

### ■ PIN CONFIGURATION

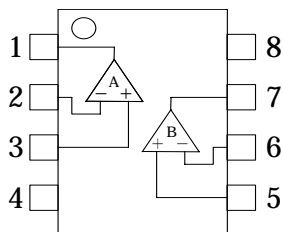

NJM12904D/12904M

NJM12904E/12904V/12904R

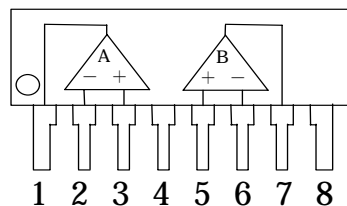

NJM12904L

### PIN FUNCTION

1. A OUTPUT
2. A -INPUT
3. A +INPUT
4. GND
5. B +INPUT
6. B -INPUT
7. B OUTPUT
8. V<sup>+</sup>

### ■ EQUIVALENT CIRCUIT (1/2Shown)

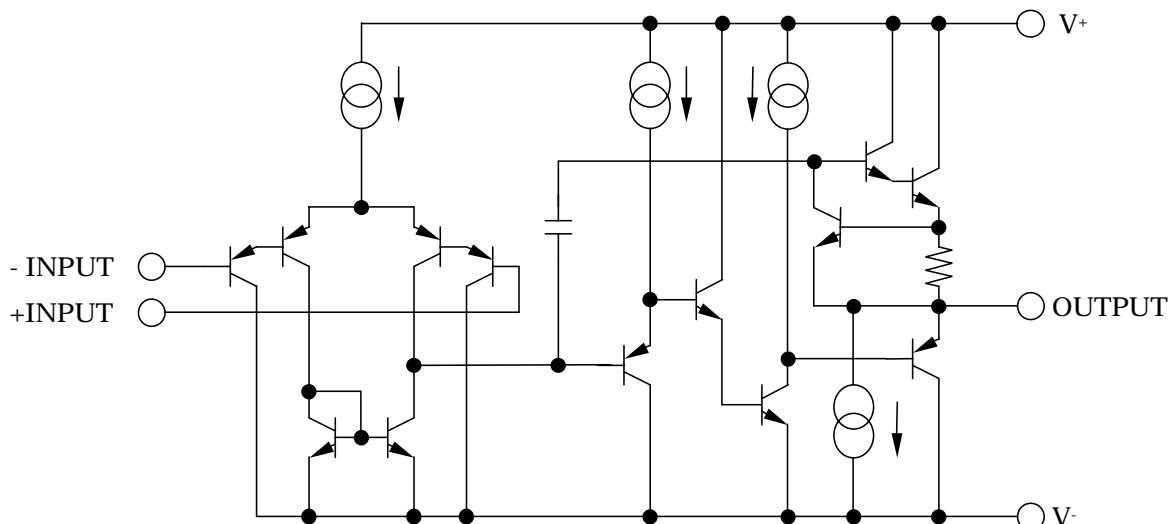

**■ ABSOLUTE MAXIMUM RATING**

(Ta=25°C)

PARAMETER	SYMBOL	RATINGS	UNIT
Supply Voltage	V <sup>+</sup>	15	V
Differential Input Voltage	V <sub>ID</sub>	14	V
Input Voltage	V <sub>IC</sub>	- 0.3 to +14	V
Power Dissipation	P <sub>D</sub>	(DIP8) 500 (DMP8) 300 (EMP8) 300 (SSOP8) 250 (VSP8) 320 (SIP8) 800	mW
Operating Temperature Range	T <sub>opr</sub>	- 40 to +85	°C
Storage Temperature Range	T <sub>stg</sub>	- 50 to +125	°C

**■ ELECTRICAL CHARACTERISTICS ( V<sup>+</sup>=5V, Ta=25°C)**

PARAMETER	SYMBOL	TEST CONDITION	MIN.	TYP.	MAX.	UNIT
Operating Voltage	V <sub>opr</sub>		2	-	14	V
Input Offset Voltage	V <sub>IO</sub>	R <sub>S</sub> =0Ω	-	1	5	mV
Input Offset Current	I <sub>IO</sub>		-	5	50	nA
Input Bias Current	I <sub>B</sub>		-	20	150	nA
Large Signal Voltage Swing	A <sub>V</sub>	R <sub>L</sub> ≥2kΩ	-	100	-	dB
Maximum Output Voltage Range	V <sub>OM</sub>	R <sub>L</sub> =2kΩ	3.5	-	-	V
Input Common Mode Voltage Range	V <sub>ICM</sub>		0 to 3.5	-	-	V
Common Mode Rejection Ratio	CMR		-	85	-	dB
Supply Voltage Rejection Ratio	SVR		-	100	-	dB
Output Source Current	I <sub>SOURCE</sub>	V <sub>IN</sub> <sup>+</sup> =1V, V <sub>IN</sub> <sup>-</sup> =0V	20	40	-	mA
Output Sink Current	I <sub>SINK</sub>	V <sub>IN</sub> <sup>+</sup> =0V, V <sub>IN</sub> <sup>-</sup> =1V	8	20	-	mA
Channel Separation	CS	f=1k to 20kHz	-	120	-	dB
Operating Current	I <sub>CC</sub>	R <sub>L</sub> =∞	-	0.7	1.2	mA
Slew Rate	SR		-	0.7	-	V/μs
Gain Bandwidth Product	GB		-	1.5	-	MHz

## ■ TYPICAL CHARACTERISTICS

NJM12904 Operating Current v.s Operating Voltage

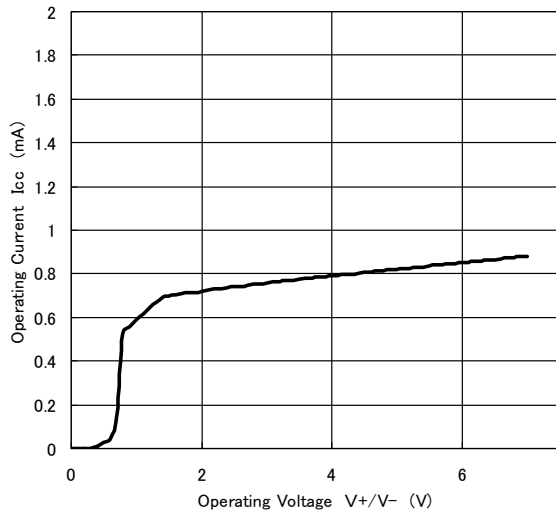

NJM12904 Input Offset Voltage v.s Operating Voltage

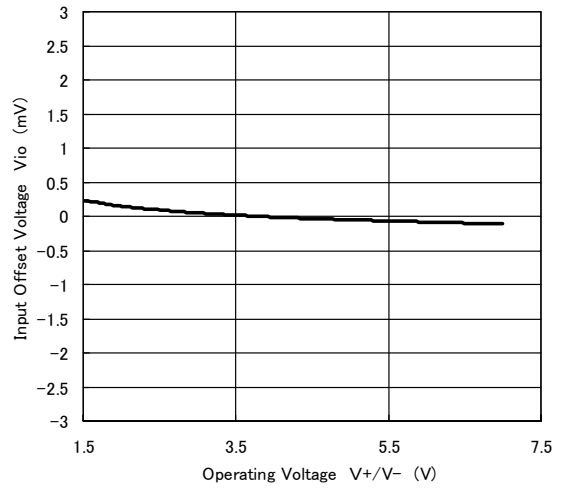

NJM12904 Input Bias Current v.s Operating Voltage

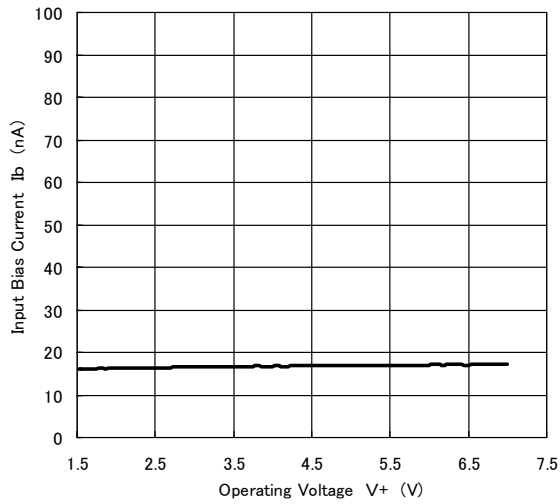

NJM12904 Maximum Output Voltage Swing v.s Operating Voltage

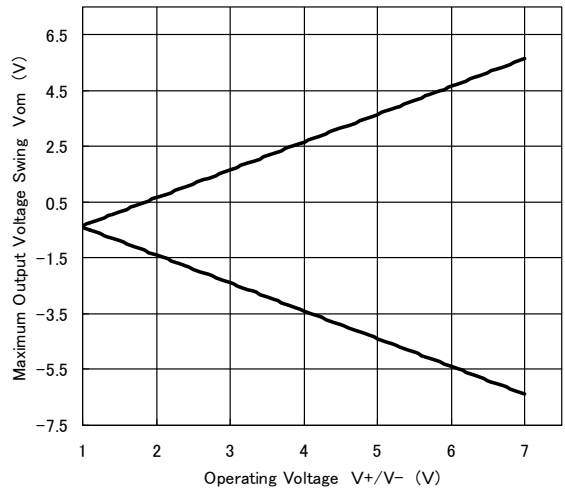

NJM12904 Input Offset Voltage v.s Input Voltage

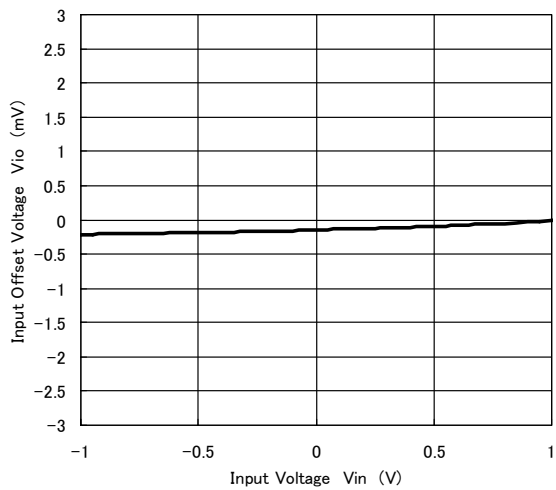

NJM12904 Maximum Output Voltage Swing v.s Load Resistance

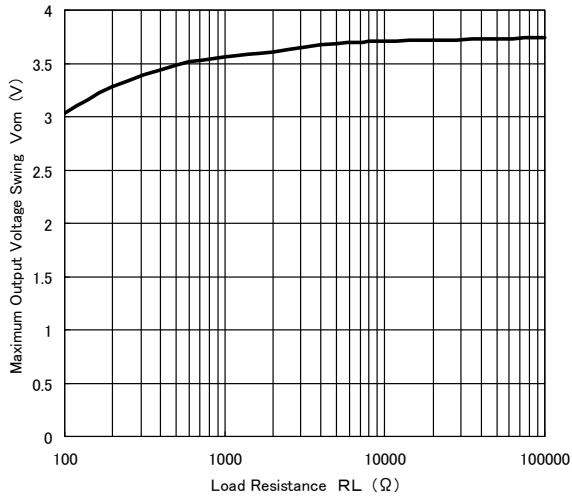

NJM12904 Maximum Output Voltage Swing v.s Frequency

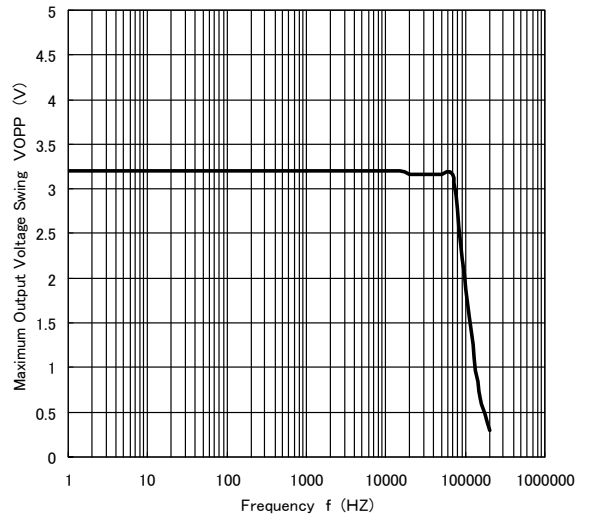

NJM12904 Output Voltage v.s Output Sink Current

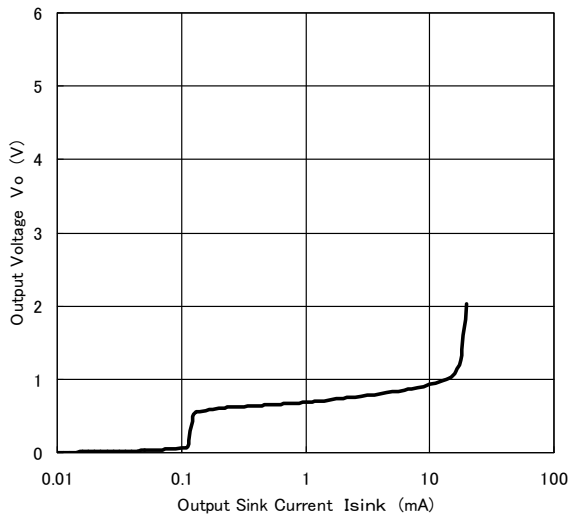

NJM12904 Output Voltage v.s Output Source Current

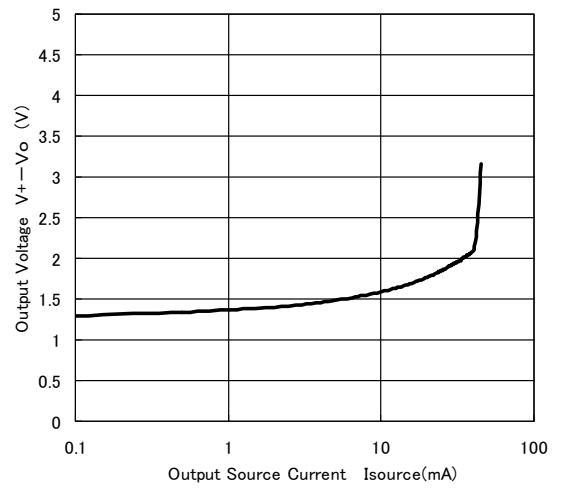

NJM12904 Voltage Gain v.s Operating Voltage

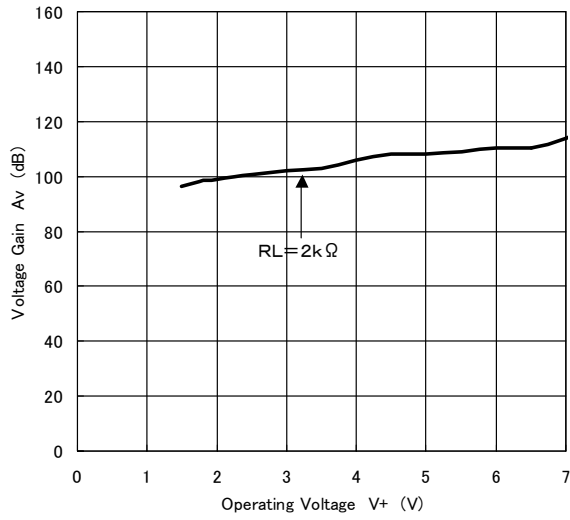

NJM12904 Voltage Gain v.s Frequency

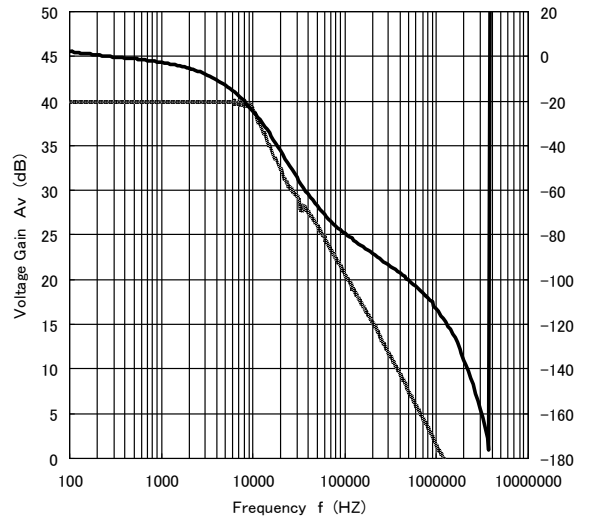

NJM12904 Slew Rate(Fall)

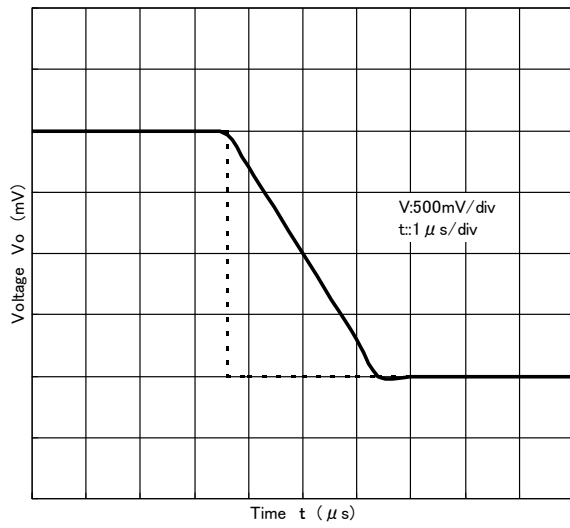

NJM12904 Slew Rate(Rise)

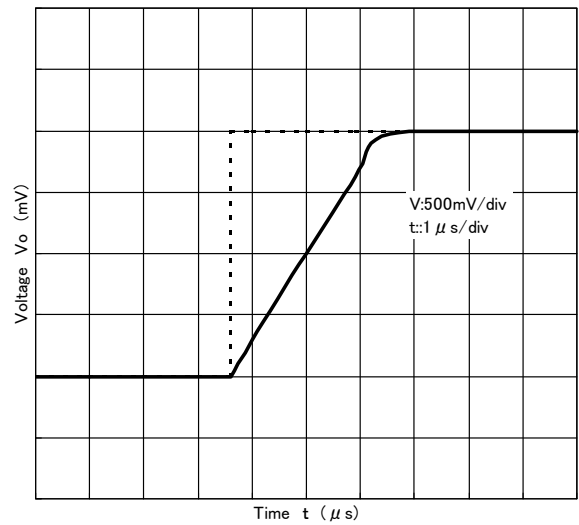

NJM12904 Operating Current v.s Ambient Temperature

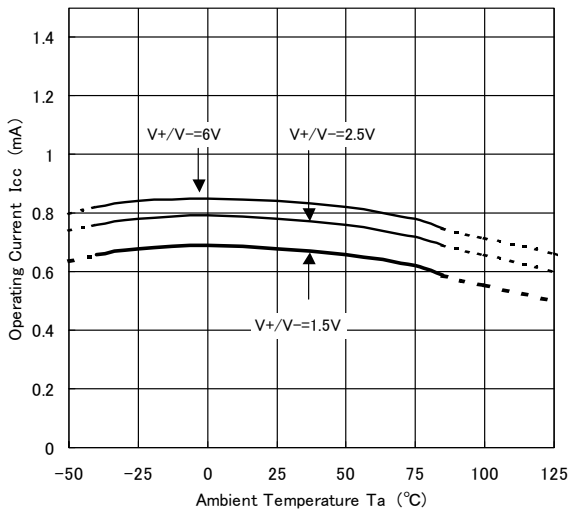

NJM12904 Input Offset Voltage v.s Ambient Temperature

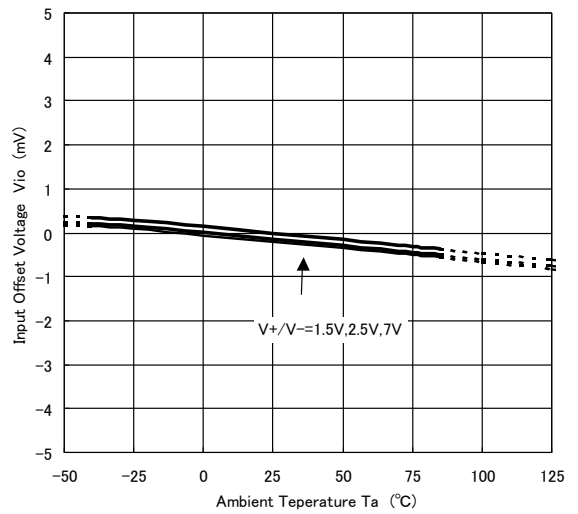

NJM12904 Input Bias Current v.s Ambient Temperature

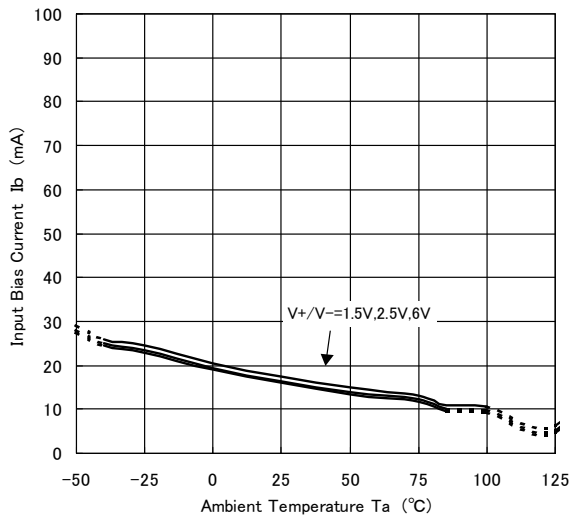

NJM12904 Maximum Output Voltage Swing v.s Ambient Temperature

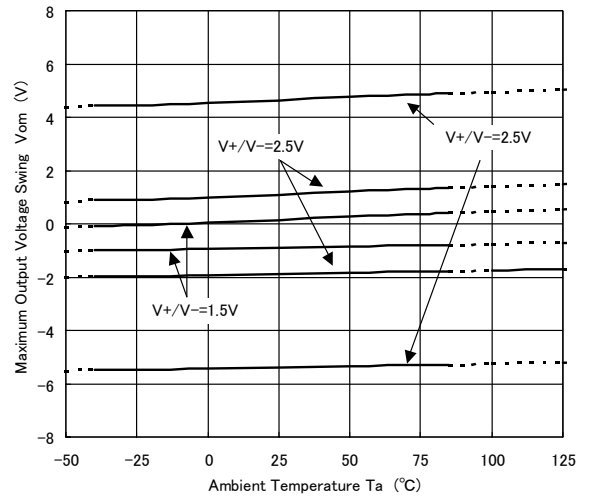

NJM12904 Output Sink Current v.s Ambient Temperature

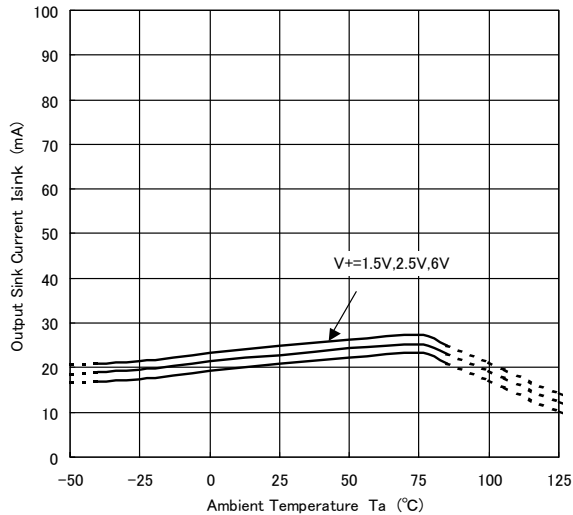

NJM12904 Output Source Current v.s Ambient Temperature

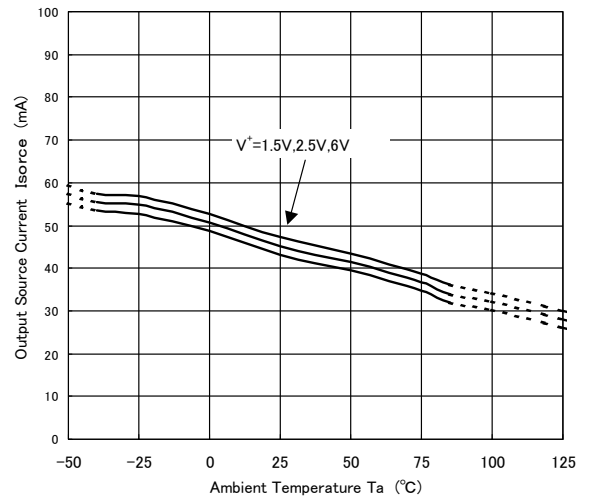

NJM12904 Voltage Gain v.s Ambient Temperature

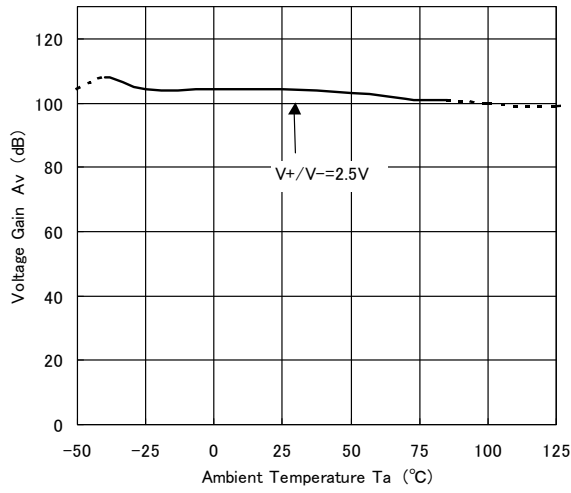

NJM12904 Common Mode Rejection Ratio v.s Ambient Temperature

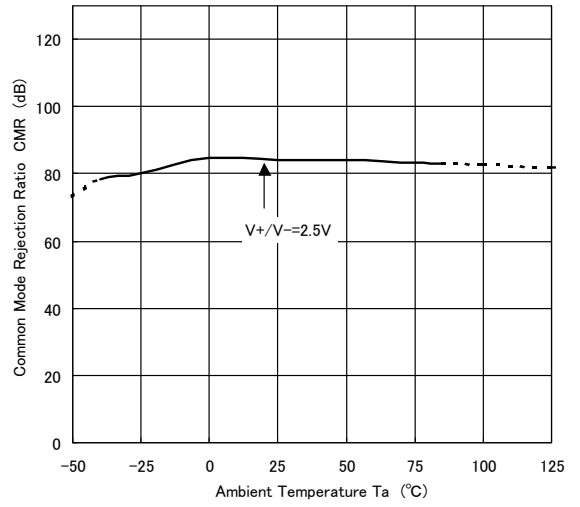

NJM12904 Supply Voltage Rejection Ratio v.s Ambient Temperature

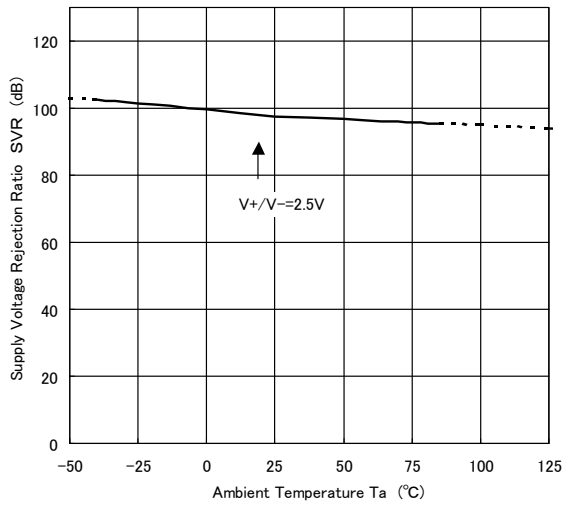

# MEMO

[CAUTION]  
The specifications on this databook are only given for information, without any guarantee as regards either mistakes or omissions. The application circuits in this databook are described only to show representative usages of the product and not intended for the guarantee or permission of any right including the industrial rights.