

## ULTRA WIDE BAND, HIGH SLEW RATE SINGLE OPERATIONAL AMPLIFIER

### ■ GENERAL DESCRIPTION

The NJM2136, NJM2137 and NJM2138 are single, dual and quad operational amplifiers operated from low voltage ( $\pm 1.35V$ ). A 200MHz gain bandwidth and  $45V/\mu s$  high slew rate make them suitable for use as active filter, high-speed analog and digital signal processor, industrial measurement equipment and others.

It can also be suitable for portable communication items because of low operating voltage and low operating current.

### ■ FEATURES

- Operating Voltage  $\pm 1.35V \sim \pm 6V$
- Wide Bandwidth 200MHz typ.
- High Slew Rate  $45V/\mu s$  typ.
- Input Offset Voltage Balance (only NJM2136)
- Operating Current NJM2136: 0.63mA typ.  
NJM2137: 1.14mA typ.  
NJM2138: 2.27mA typ.
- Bipolar Technology
- Package Outline NJM2136: DMP8, SSOP8  
NJM2137: DIP8, DMP8, SSOP8  
NJM2138: DMP14, SSOP14

### ■ PACKAGE OUTLINE

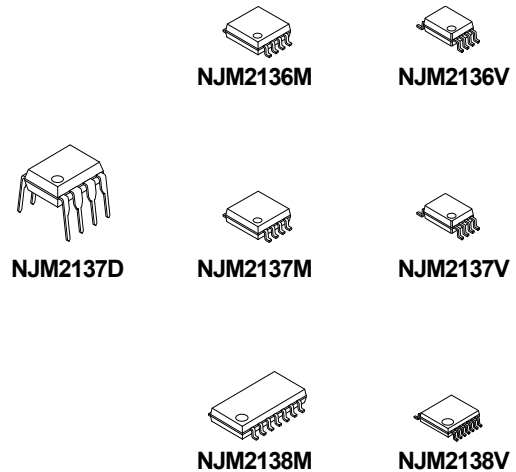

### ■ PIN CONFIGURATION

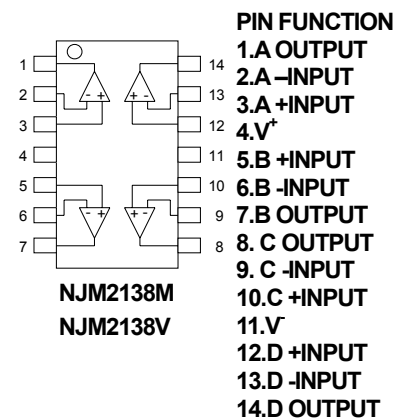
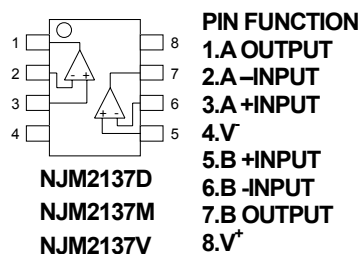
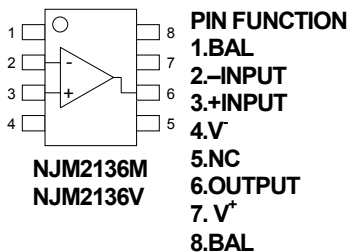

### ■ EQUIVALENT CIRCUIT (each amplifier)

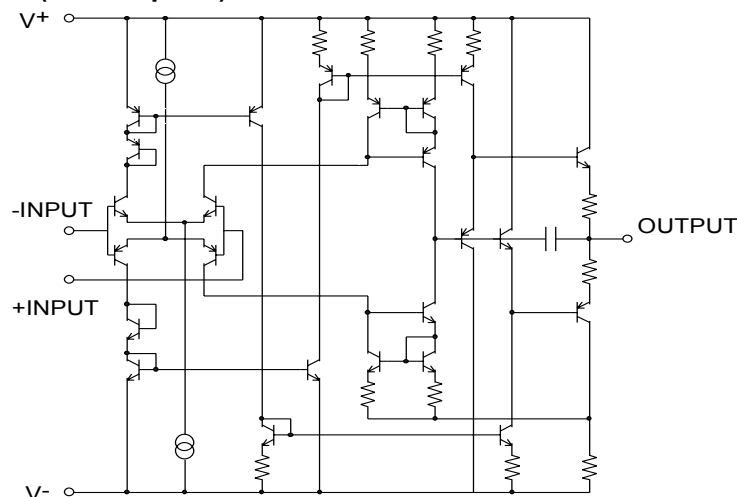

# NJM2136/37/38

## ■ ABSOLUTE MAXIMUM RATINGS

( Ta=25°C )

PARAMETER	SYMBOL	RATINGS	UNIT
Supply Voltage	V <sup>+</sup> /V <sup>-</sup>	± 6.75	V
Differential Input Voltage	V <sub>ID</sub>	± 3	V
Power Dissipation	P <sub>D</sub>	(DIP8) 500 (DMP8) 300 (SSOP8) 250 (DMP14) 300 (SSOP14) 300	mW
Operating Temperature Range	T <sub>opr</sub>	-40~+85	°C
Storage Temperature Range	T <sub>stg</sub>	-50~+125	°C

## ■ ELECTRICAL CHARACTERISTICS

( V<sup>+</sup>/V<sup>-</sup>=±2.5V, Ta=25°C )

PARAMETER	SYMBOL	TEST CONDITION	MIN.	TYP.	MAX.	UNIT
Operating Voltage	V <sup>+</sup> /V <sup>-</sup>		± 1.35	-	± 6.00	V
Input Offset Voltage	V <sub>IO</sub>	R <sub>S</sub> =0Ω	-	1.0	5.0	mV
Input Bias Current	I <sub>B</sub>		-	0.5	2.0	μA
Input Offset Current	I <sub>IO</sub>		-	20	200	nA
Large Signal Voltage Gain	A <sub>V</sub>	R <sub>L</sub> ≥2kΩ	65	75	-	dB
Input Common Mode Voltage Range	V <sub>ICM</sub>		±1.2	±1.5	-	V
Common Mode Rejection Ratio	CMR	-1V≤V <sub>cm</sub> ≤+1V	45	60	-	dB
Supply Voltage Rejection Ratio	+SVR	NJM2136	70	80	-	dB
	-SVR		50	60	-	
	+SVR	NJM2137/NJM2138	50	60	-	
	-SVR		70	80	-	
Maximum Output Voltage Swing	V <sub>OM</sub>	R <sub>L</sub> =1kΩ	1.1 -0.9	1.4 -1.2	-	V
Operating Current (all Amp.)	I <sub>CC</sub>	NJM2136, R <sub>L</sub> =∞	-	0.63	0.82	mA
		NJM2137, R <sub>L</sub> =∞	-	1.14	1.50	
		NJM2138, R <sub>L</sub> =∞	-	2.27	3.00	
Slew Rate	SR	A <sub>v</sub> =0dB	-	45	-	V/μs
Gain Bandwidth Product	GB	60dB • 500kHz	120	200	-	MHz
Phase Margin	∅ <sub>M</sub>	40dB	-	25	-	deg.
Unity Gain Bandwidth	f <sub>T</sub>	40dB	-	40	-	MHz

## ■ OFFSET ADJUSTMENT METHOD (only NJM2136)

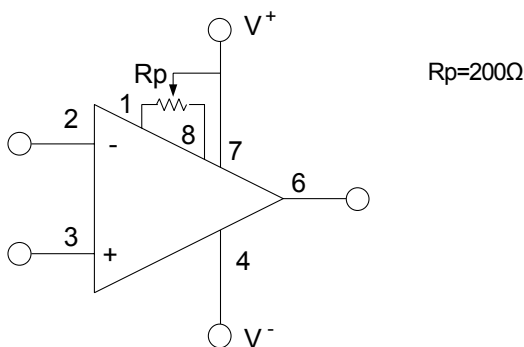

( note ) The electrical characteristics change a little, in case the R<sub>P</sub> is connected.

## ■ TYPICAL CHARACTERISTICS

**Operating Current vs. Supply Voltage**  
 $G_v=0\text{dB}$ ,  $T_a=25^\circ\text{C}$

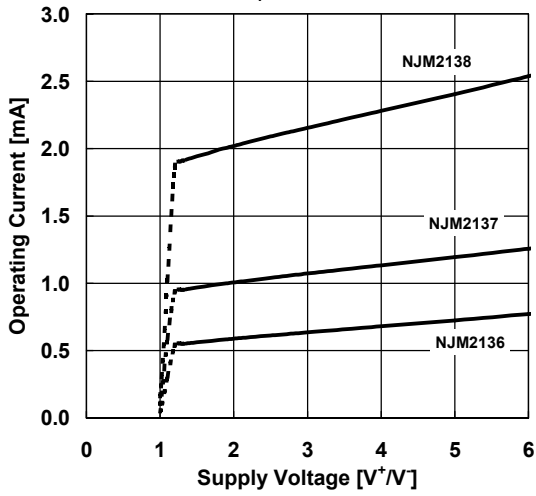

**Operating Current vs. Temperature**  
 $V^+/V^-=\pm 2.5\text{V}$ ,  $G_v=0\text{dB}$

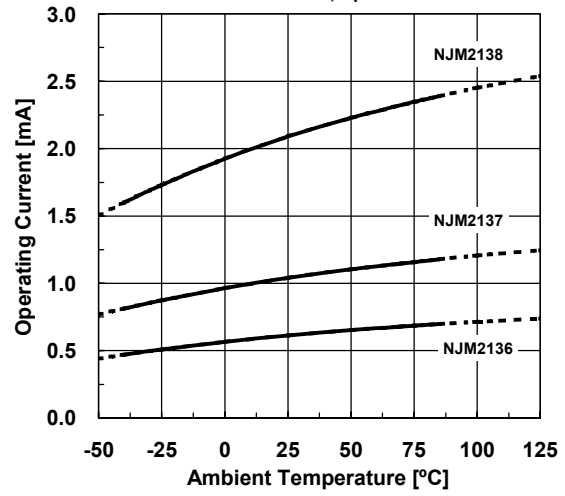

**Input Offset Voltage vs. Temperature**  
 $V^+/V^-=\pm 2.5\text{V}$ ,  $G_v=0\text{dB}$ ,  $T_a=25^\circ\text{C}$

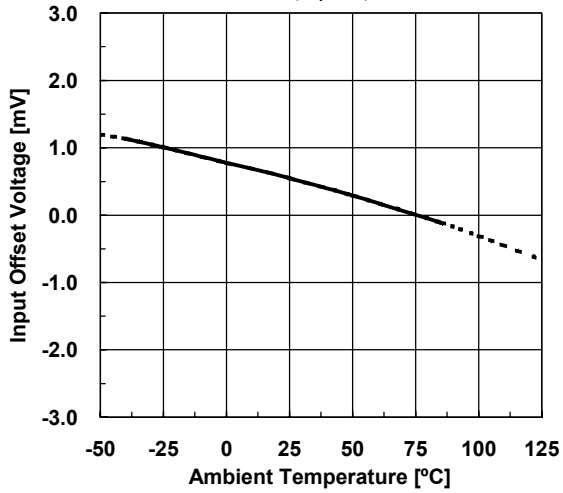

**Input Offset Current vs. Temperature**  
 $V^+/V^-=\pm 2.5\text{V}$ ,  $G_v=0\text{dB}$ ,  $T_a=25^\circ\text{C}$

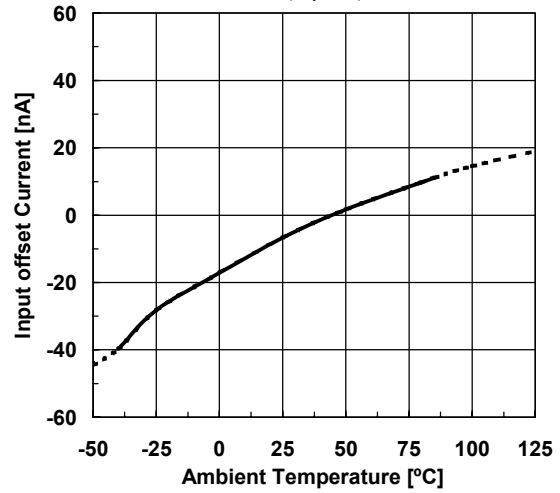

**Input Bias Current vs. Temperature**  
 $V^+/V^-=\pm 2.5\text{V}$ ,  $G_v=0\text{dB}$ ,  $T_a=25^\circ\text{C}$

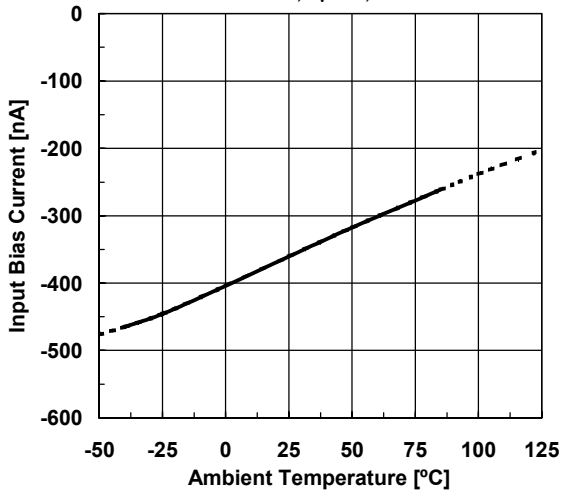

# NJM2136/37/38

## ■ TYPICAL CHARACTERISTICS

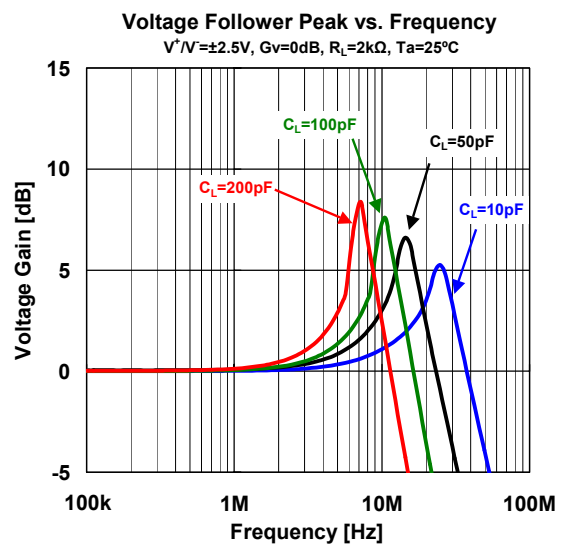
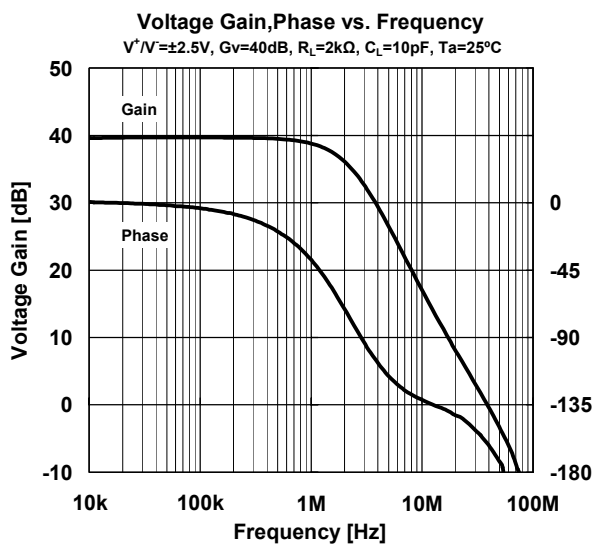
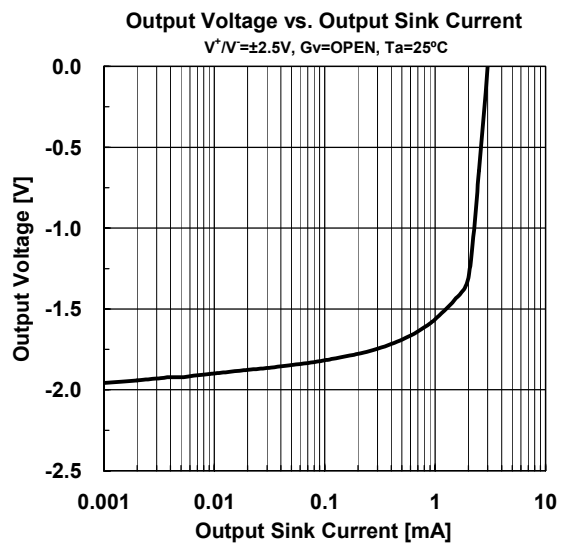
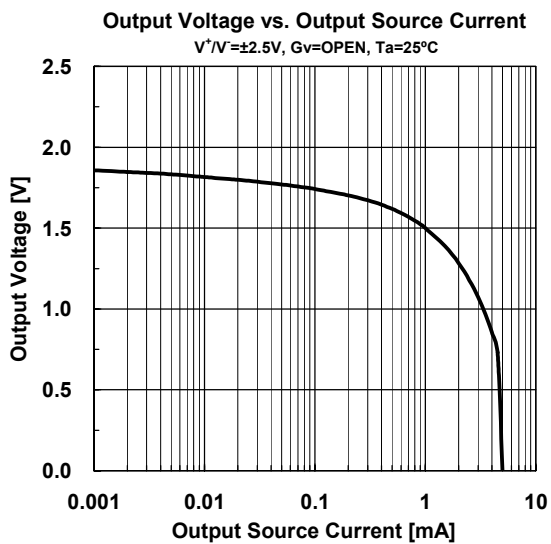
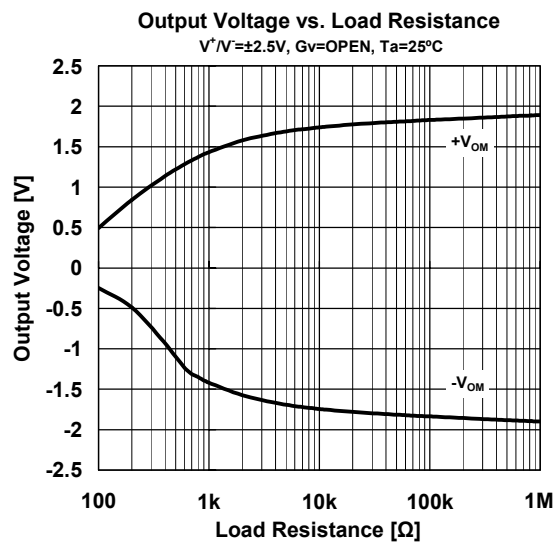
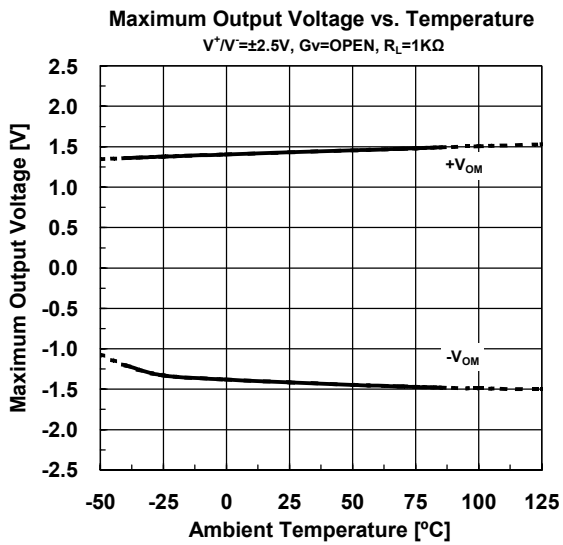

## ■ TYPICAL CHARACTERISTICS

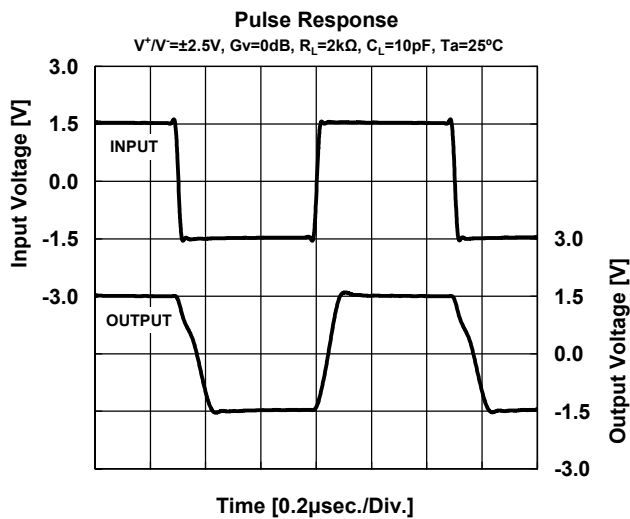
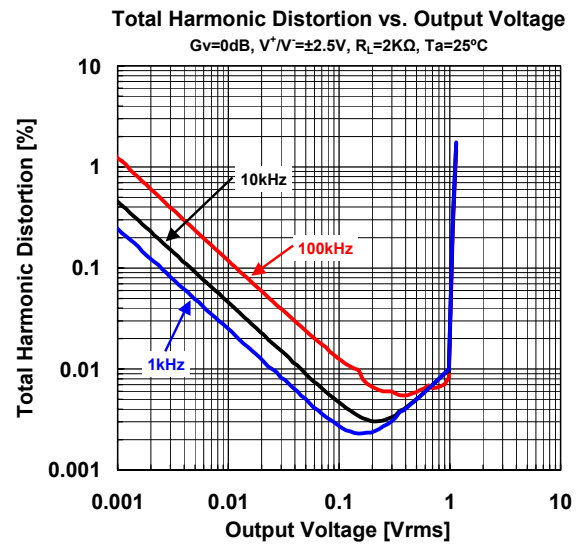
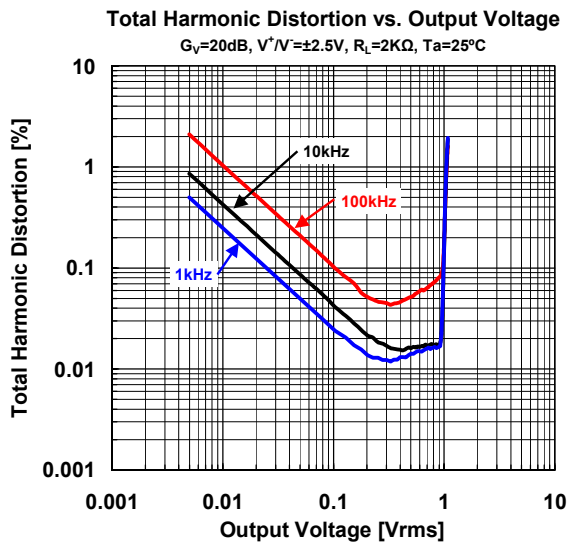

**[CAUTION]**

The specifications on this databook are only given for information, without any guarantee as regards either mistakes or omissions. The application circuits in this databook are described only to show representative usages of the product and not intended for the guarantee or permission of any right including the industrial rights.