

## REMOTE-CONTROL INTERFACE

### ■ GENERAL DESCRIPTION

The **NJM2145** is a remote-control Interface for television, VCR, receiver, and others.

Some items are connected through the OUT2 (two-way) terminal, then all of items are controlled when the control signal from any remote-control commander is transmitted to one of items.

If a few OUT2 terminals are open, the **NJM2145** operates normally by its error protection circuit.

### ■ PACKAGE OUTLINE

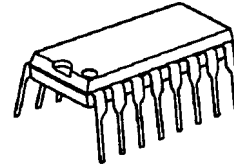

**NJM2145D**

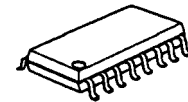

**NJM2145M**

### ■ FEATURES

- Operating Voltage (4.75V to 5.25V)
- Internal Error Protection Circuit against open OUT2 terminal
- OUT2 (Tow-Way) x 3
- Internal Output Short Protection
- Bipolar Technology
- Package Outline DIP16, DMP16

### ■ PIN CONFIGURATION

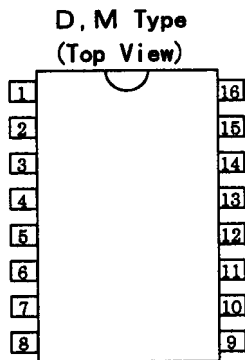

#### PIN FUNCTION

1. $V^+$	9. OUT2-3
2. OUT1	10. OUT2-2
3. IN4	11. OUT2-1
4. IN3	12. NC
5. IN2	13. IN1
6. OUT3-1	14. INH2
7. OUT3-2	15. INH1
8. OUT3-3	16. GND

### ■ BLOCK DIAGRAM

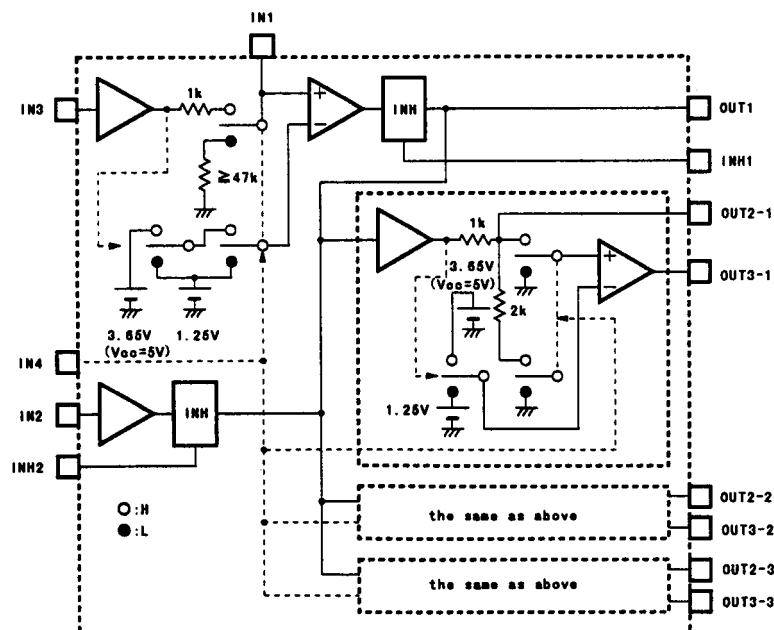

# NJM2145

## ■ ABSOLUTE MAXIMUM RATINGS

(T<sub>a</sub> = 25°C)

PARAMETER	SYMBOL	RATINGS	UNIT
Supply Voltage	V <sup>+</sup>	7	V
Power Dissipation	P <sub>D</sub>	(DIP16) 700 (DMP16) 300	mW
Operating Temperature Range	T <sub>opr</sub>	-20 to +75	°C
Storage Temperature Range	T <sub>stg</sub>	-40 to +125	°C

## ■ ELECTRICAL CHARACTERISTICS (V<sup>+</sup> = 5V, T<sub>a</sub> = 25°C)

PARAMETER	SYMBOL	TEST CONDITION							MIN.	TYP.	MAX.	UNIT
		IN2	IN3	IN4	V1	V2	V3	RL				
Operating Supply Voltage	V <sub>opr</sub>	-	-	-	-	-	-	-	4.75	5.0	5.25	V
Operating Current 1	I <sub>cc1</sub>	1.5	1.5	1.5	0.0	0.0	Open	47kΩ	-	2.0	4.0	mA
Operating Current 2	I <sub>cc2</sub>	3.5	3.5	3.5	0.0	0.0	Open	1kΩ	-	10	13	mA
IN1-High Electric Potential Output Voltage1	IN1-H1	-	3.5	3.5	5.0	-	-	1kΩ	3.5	-	5.0	V
IN1-Low Electric Potential Output Voltage1	IN1-L1	-	1.5	3.5	5.0	-	-	1kΩ	2.0	2.5	3.0	V
IN1-High Electric Potential Output Voltage2	IN1-H2	-	3.5	3.5	0.0	-	-	1kΩ	2.0	2.5	3.0	V
IN1-Low Electric Potential Output Voltage2	IN1-L2	-	1.5	3.5	0.0	-	-	1kΩ	0.0	-	1.5	V
IN1-Input Impedance	IN1-imp	-	3.5	1.5	5.0	-	-	47kΩ	47	80	120	kΩ

■ **ELECTRICAL CHARACTERISTICS** ( $V^+ = 5V, T_a = 25^\circ C$ )

PARAMETER	SYMBOL	TEST CONDITION							MIN.	TYP.	MAX.	UNIT
		IN2	IN3	IN4	V1	V2	V3	RL				
OUT1-High Electric Potential Output Voltage1	OUT1-H1	-	3.5	3.5	1.0	-	Open	1k $\Omega$	3.5	-	5.0	V
OUT1-High Electric Potential Output Voltage2	OUT1-H2	-	1.5	3.5	INH*	-	0.0	1k $\Omega$	3.5	-	5.0	V
OUT1-Low Electric Potential Output Voltage	OUT1-L	-	3.5	3.5	4.0	-	Open	1k $\Omega$	0.0	-	1.5	V
OUT2-High Electric Potential Output Voltage1	OUT2-H1	INH*	-	3.5	-	5.0	Open	1k $\Omega$	3.5	4.0	4.5	V
OUT2-Low Electric Potential Output Voltage1	OUT2-L1	1.5	-	3.5	-	5.0	Open	1k $\Omega$	1.5	2.0	2.5	V
OUT2-High Electric Potential Output Voltage2	OUT2-H2	INH*	-	3.5	-	0.0	Open	1k $\Omega$	1.5	2.0	2.5	V
OUT2-Low Electric Potential Output Voltage2	OUT2-L2	1.5	-	3.5	-	0.0	Open	1k $\Omega$	0.0	-	1.5	V
OUT2-High Electric Potential Output Voltage3	OUT2-H3	1.5	-	1.5	-	0.0	1.5	47k $\Omega$	3.5	-	5.0	V
OUT2-Low Electric Potential Output Voltage3	OUT2-L3	1.5	-	1.5	-	5.0	Open	47k $\Omega$	0.0	-	1.5	V
OUT3-High Electric Potential Output Voltage	OUT3-H	3.5	-	3.5	4.0	0.0	Open	47k $\Omega$	3.5	-	5.0	V
OUT3-Low Electric Potential Output Voltage1	OUT3-L1	1.5	-	3.5	1.0	5.0	Open	47k $\Omega$	0.0	-	1.5	V
OUT3-Low Electric Potential Output Voltage2	OUT3-L2	3.5	-	1.5	1.0	5.0	Open	47k $\Omega$	0.0	-	1.5	V
IN1, OUT2 Input Threshold Voltage1	V <sub>TH1-1</sub>	-	-	1.5	-	-	-	-	1.0	1.3	2.0	V
IN1, OUT2 Input Threshold Voltage2	V <sub>TH1-2</sub>	-	3.5	3.5	-	-	-	-	3.0	3.65	4.5	V
IN2, IN3, IN4 Input Threshold Voltage	V <sub>TH2</sub>	-	-	-	-	-	-	-	2.0	2.5	3.0	V
Inhibit Time1 (IN1→OUT1)	INH1	-	1.5	3.5	INH*	-	0.0	1k $\Omega$	20	60	100	msec
Inhibit Time2 (IN2→OUT2)	INH2	INH*	-	3.5	-	5.0	0.0	1k $\Omega$	20	60	100	msec
Slew Switch	SS	V <sup>+</sup> = 0V, IN1 = 3.5V						47k $\Omega$	3.5	-	4.0	V

# NJM2145

## ■ TEST CIRCUIT

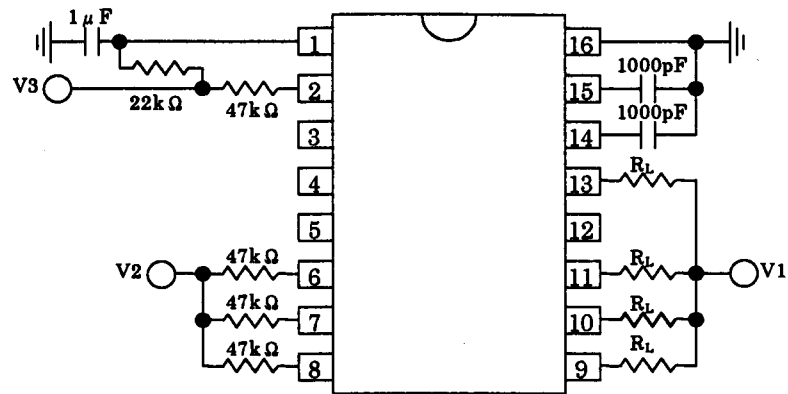

## ■ TYPICAL CHARACTERISTICS

INHIBIT Time vs. Outside Capacitor  
( $V_{cc1}=5V, T_a=25^\circ C$ )

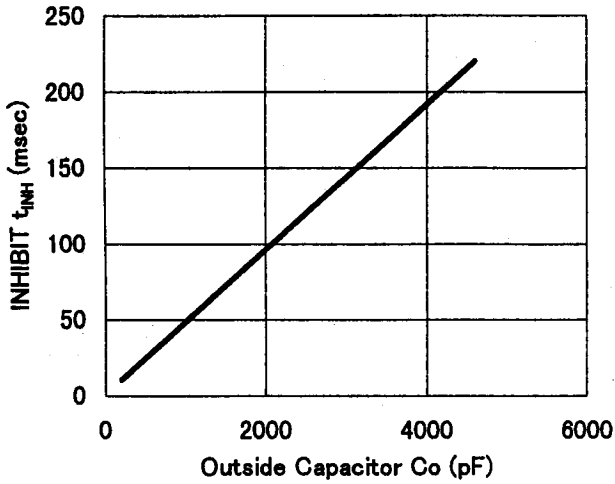

INHIBIT Time vs. Temperature  
( $V_{cc1} = 5V, C = 1000pF$ )

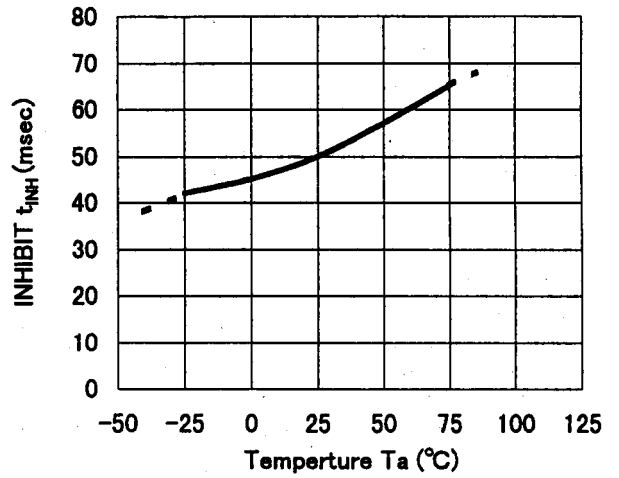

Out 2 Output Voltage vs. Load Resistance  
( $V_{cc1}=IN2=5V, T_a=25^\circ C$ )

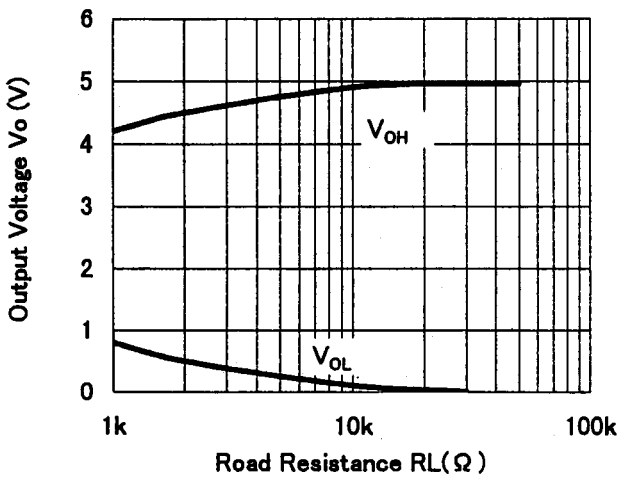

Regulator Output Characteristics  
( $V_{cc1}=5V, R_L=100\Omega, T_a=25^\circ C$ )

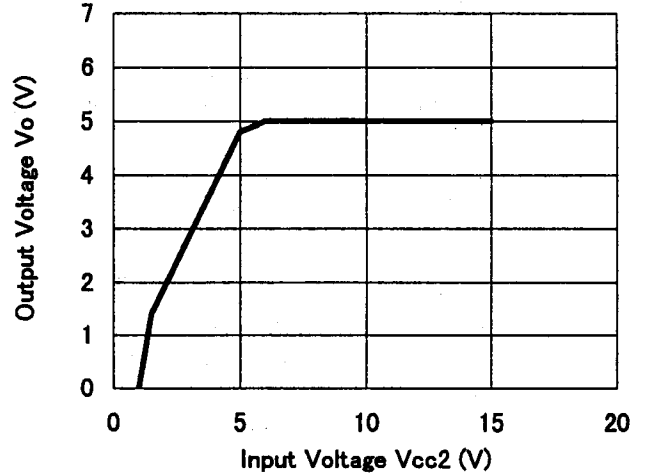

Regulator Load Characteristics  
( $V_{cc1}=5V, V_{cc2}=5.9V, T_a=25^\circ C$ )

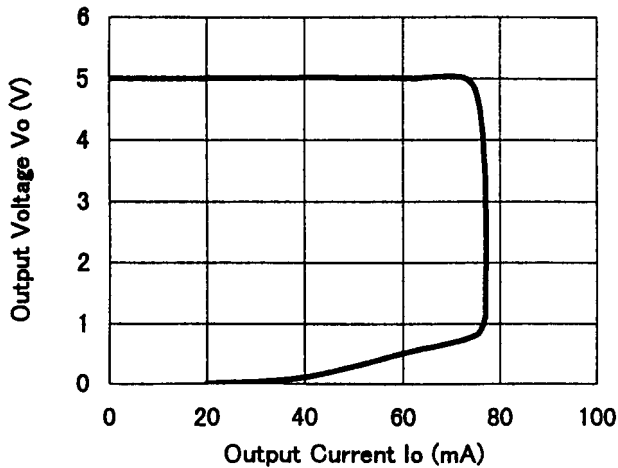

Ripple Rejection

( $V_{cc1}=5V, V_{cc2}=5.9V+300mV_{rms}, R_L=100\Omega, T_a=25^\circ C$ )

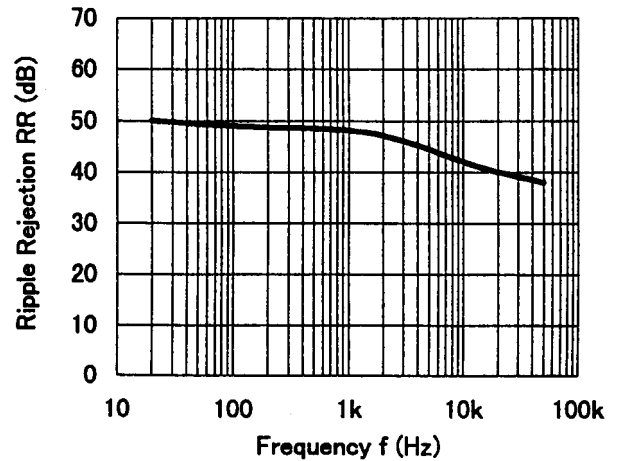

**[CAUTION]**

The specifications on this databook are only given for information, without any guarantee as regards either mistakes or omissions. The application circuits in this databook are described only to show representative usages of the product and not intended for the guarantee or permission of any right including the industrial rights.