

LOW DROPOUT VOLTAGE REGULATOR WITH ON/OFF CONTROL

■ GENERAL DESCRIPTION

The NJM2396 is low dropout voltage regulator with ON/OFF control.

The output current is up to 1.5A and dropout voltage is 0.2V typ. at $I_o=0.5A$.

The NJM2396 is suitable for power module, TV, Display, car stereo and low power applications.

■ PACKAGE OUTLINE

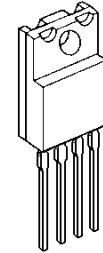

NJM2396F

■ FEATURE

- Low Dropout Voltage $\Delta V_{I-O}=0.2V$ typ. at $I_o=0.5A$
- Output Current $I_o(\text{max.})=1.5A$
- ON/OFF Control
- Internal Short Circuit Current Limit
- Internal Thermal Overload Protection
- Bipolar Technology
- Package Outline TO-220F-4

■ PIN CONFIGURATION

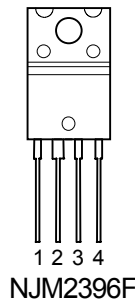

PIN FUNCTION

1. V_{IN}
2. V_{OUT}
3. GND
4. ON/OFF CONTROL

NJM2396F

■ OUTPUT VOLTAGE RANK LIST

Device Name	V_{OUT}
NJM2396F33	3.3V
NJM2396F05	5.0V
NJM2396F63	6.3V
NJM2396F08	8.0V
NJM2396F83	8.3V
NJM2396F09	9.0V
NJM2396F12	12.0V

■ EQUIVALENT CIRCUIT

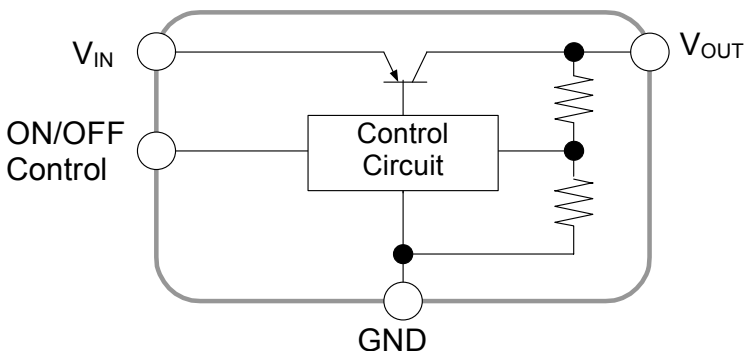

NJM2396

■ ABSOLUTE MAXIMUM RATINGS

(Ta=25°C)

PARAMETER	SYMBOL	RATINGS	UNIT
Input Voltage	V_{IN}	+35	V
Control Voltage	V_{CONT}	+35(*1)	V
Output Current	I_o	1.5	A
Power Dissipation	P_D	18(Tc<50°C)	W
Operating Junction Temperature Range	T_j	-40 to +150	°C
Operating Temperature Range	T_{opr}	-40 to 85	°C
Storage Temperature Range	T_{stg}	-50 to 150	°C

(*1): When input voltage is less than +35V, the absolute maximum control voltage is equal to the input voltage.

■ ELECTRICAL CHARACTERISTICS ($V_{IN}=V_O+1V, I_o=0.5A, C_{IN}=0.33\mu F, C_o=22\mu F, T_j=25^\circ C$)

Measurement is to be conducted is pulse testing.

PARAMETER	SYMBOL	CONDITIONS	MIN.	TYP.	MAX.	UNIT
Output Voltage	V_o	$V_{IN}=V_O+1V$	-4%	-	+4%	V
Line Regulation	$\Delta V_o/\Delta V_{IN}$	$V_{IN}=V_O+1V$ to V_O+17V	-	0.04	0.16	%/V
Load Regulation	$\Delta V_o/\Delta I_o$	$V_{IN}=V_O+2V, I_o=0A$ to 1.5A	-	0.2	1.4	%/A
Average Temperature Coefficient of Output Voltage	$\Delta V_o/\Delta T$	$T_j=0$ to $125^\circ C$	-	± 0.02	-	%/°C
Standby Current	I_Q	$I_o=0A$	-	-	5	mA
Dropout Voltage	ΔV_{LO}	$I_o=0.5A$	-	0.2	0.5	V
Ripple Rejection	NJM2396F33	RR $V_{IN}=V_O+2V$ $e_{in}=0.5V_{rms}, f=120Hz$	52	60	-	dB
	NJM2396F05		52	60	-	
	NJM2396F63		52	60	-	
	NJM2396F08		50	58	-	
	NJM2396F83		50	58	-	
	NJM2396F09		50	58	-	
	NJM2396F12		48	58	-	
ON Control Voltage	$V_{CONT(ON)}$		2.0(*2)	-	-	V
OFF Control Voltage	$V_{CONT(OFF)}$		-	-	0.4	V
ON Control Current	$I_{CONT(ON)}$	$V_C=2.7V$	-	-	20	μA
OFF Control Current	$I_{CONT(OFF)}$	$V_C=0.4V$	-	-	-20	μA

(*2): When ON/OFF CONTROL Terminal is open, Output Voltage is ON.

■ TEST CIRCUIT

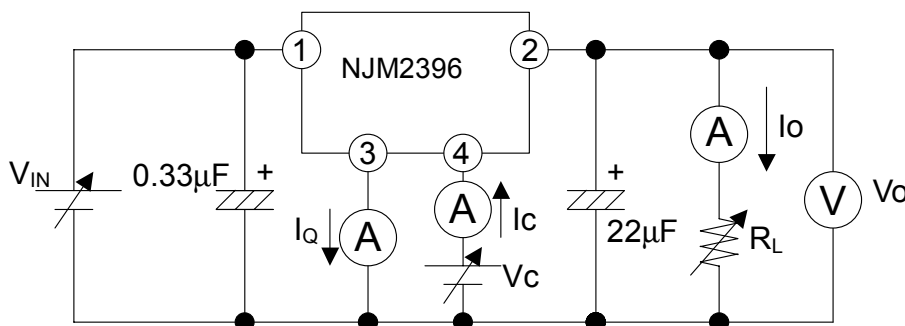

POWER DISSIPATION vs. AMBIENT TEMPERATURE

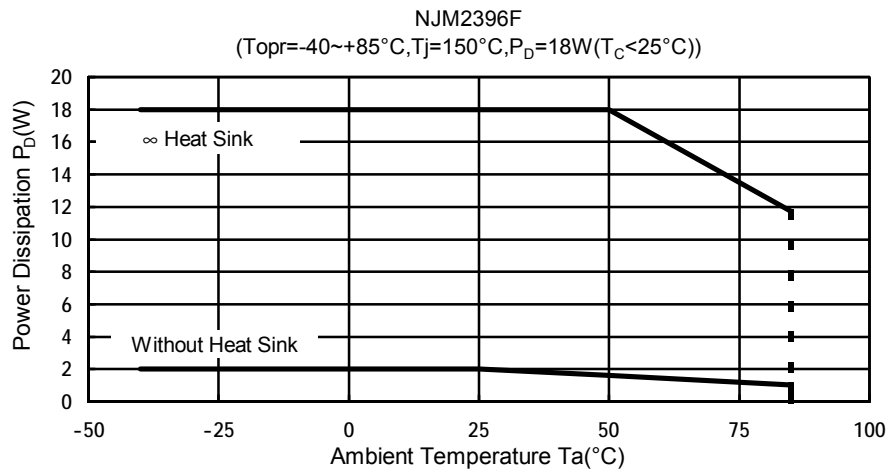

NJM2396

TYPICAL CHARACTERISTICS

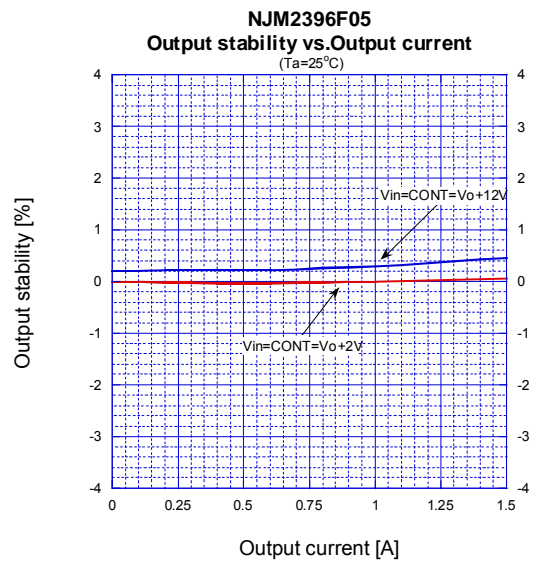
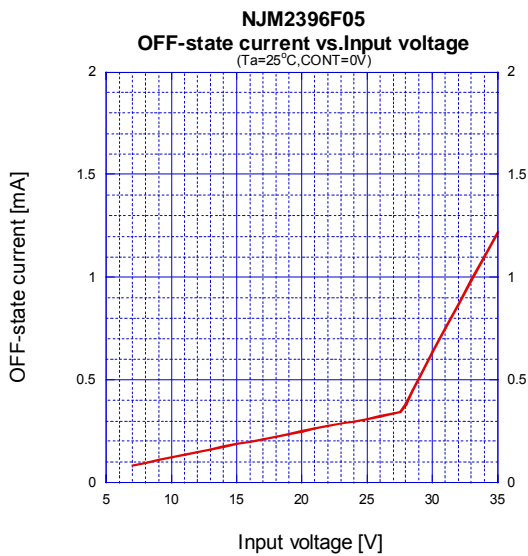
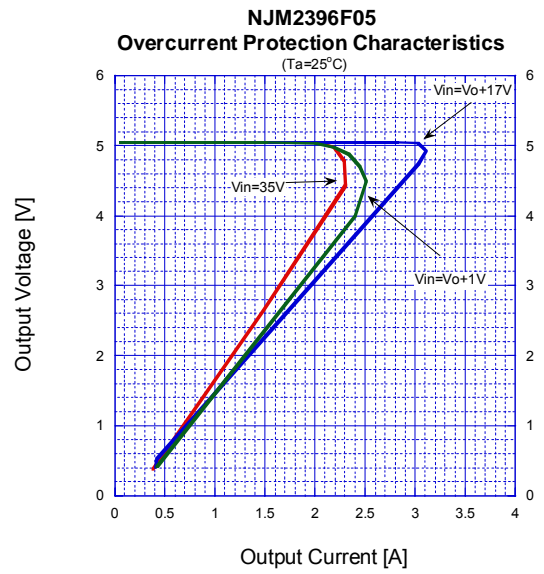
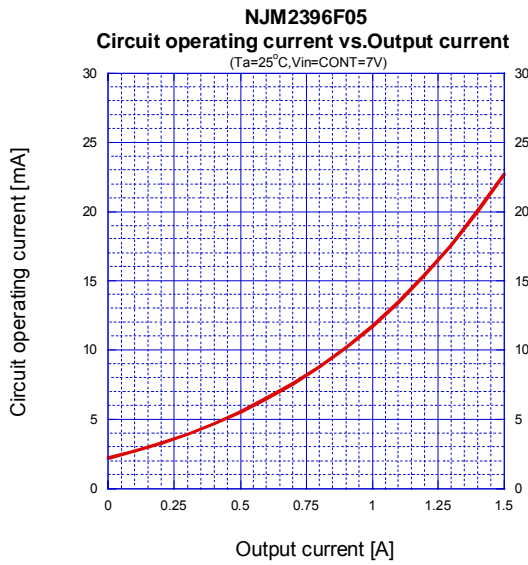
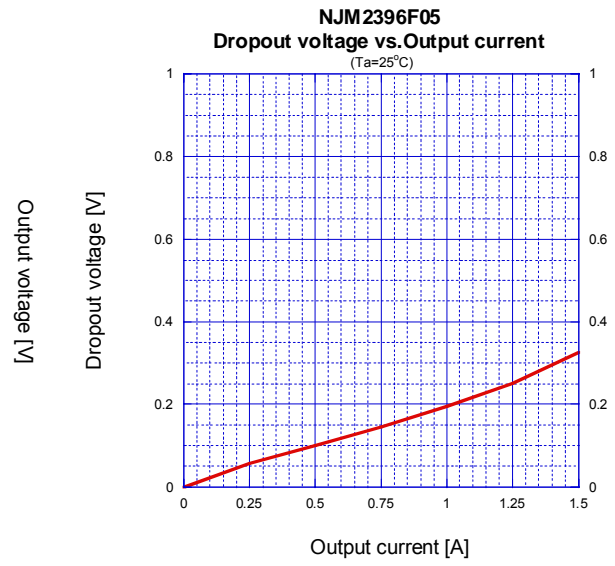
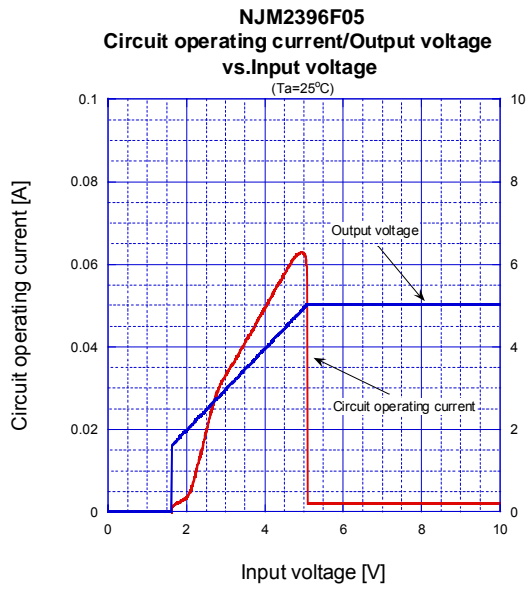

TYPICAL CHARACTERISTICS

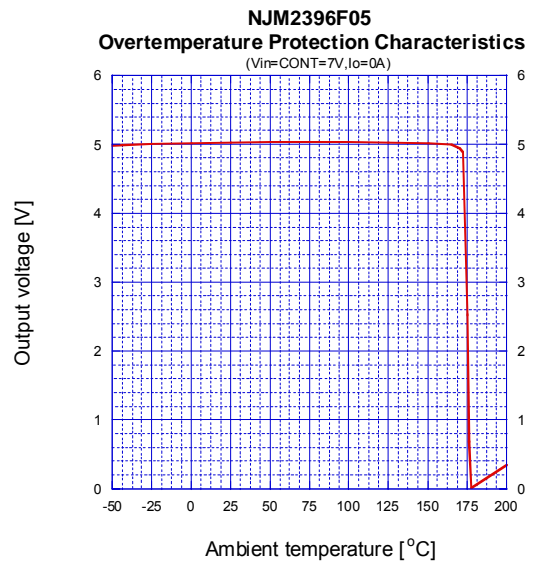
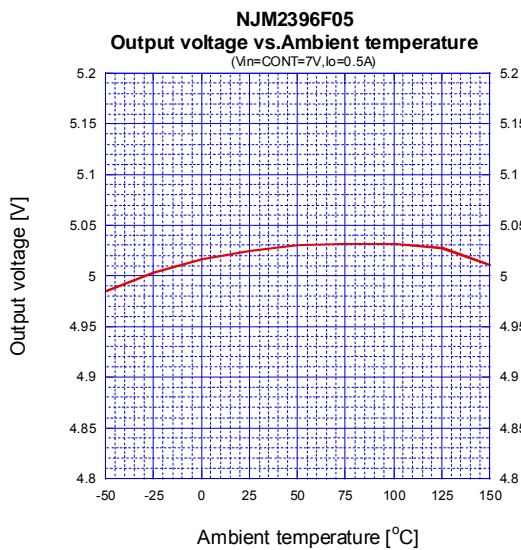
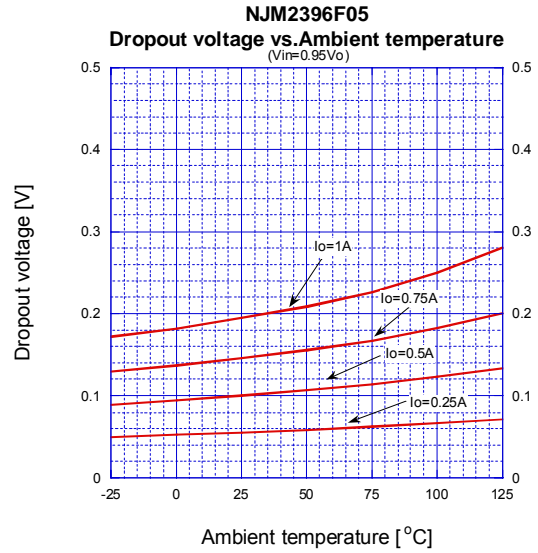
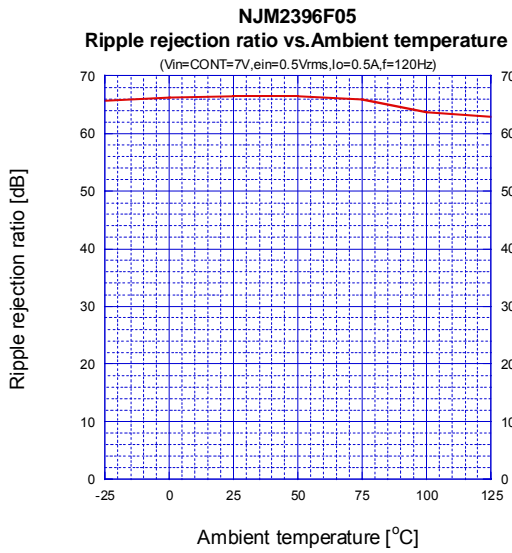
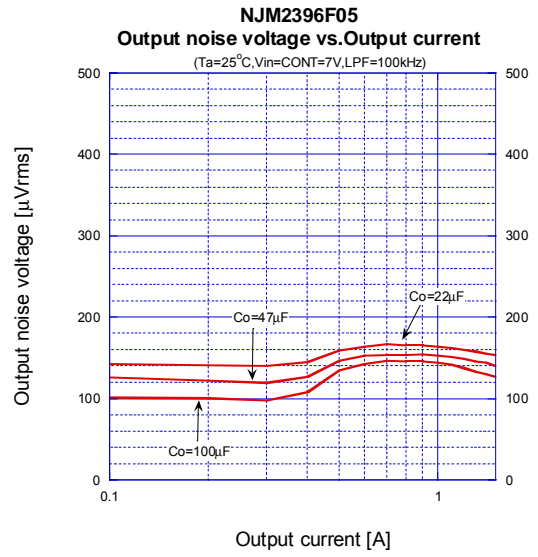
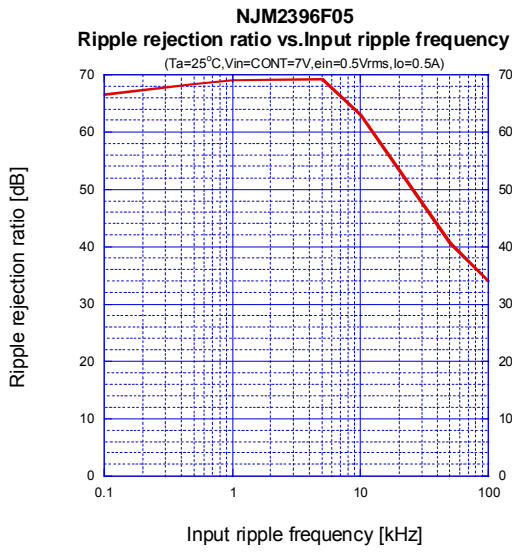

NJM2396

TYPICAL CHARACTERISTICS

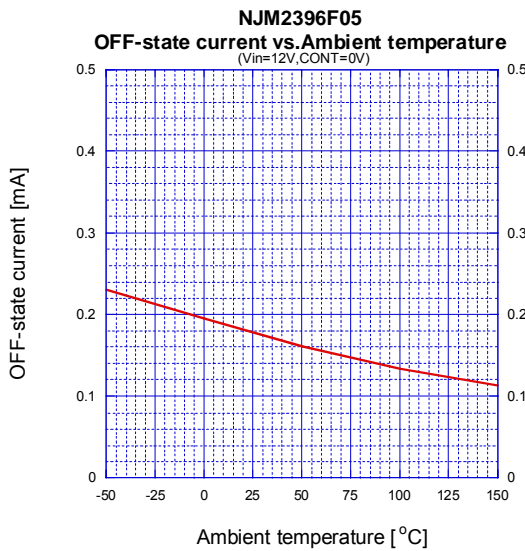
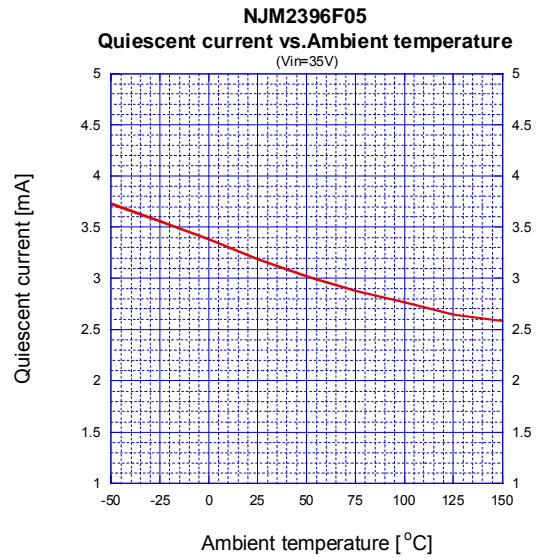
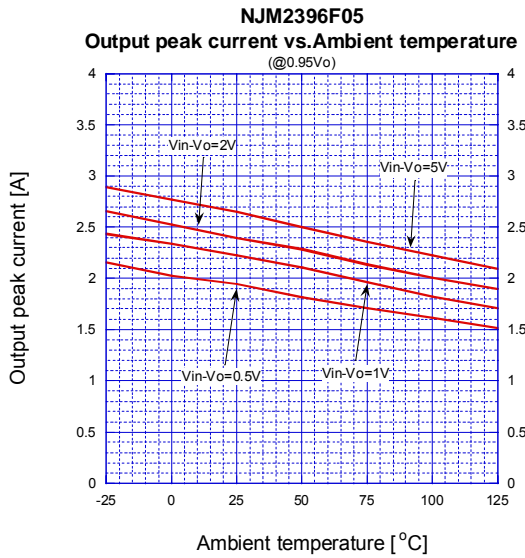

[CAUTION]
The specifications on this databook are only given for information, without any guarantee as regards either mistakes or omissions. The application circuits in this databook are described only to show representative usages of the product and not intended for the guarantee or permission of any right including the industrial rights.