

ULTRA HIGH SPEED SINGLE OPERATIONAL AMPLIFIER

■ GENERAL DESCRIPTION

The **NJM2711** is an ultra high speed single operational amplifier.

It can swings 260V/μs high slew rate and 1GHz gain band width product(10MHz typ. at 40dB) at ±2.5V.

It is suitable for pickup circuit of CD-R/RW or DVD-R/RW, wideband video system, high resolution scanner or FAX, high speed telecommunications, and any other high speed signal processing system.

■ PACKAGR OUTLINE



NJM2711F

■ FEATURES

- Operating Voltage (±2.0 to ±4.5V)
- Operating Current (1.9mA typ. at $V^+/V^- = \pm 2.5V$)
- High Slew Rate (260V/μs typ.)
- Gain Bandwidth Product (1GHz typ.)
- Bandwidth (10MHz typ. at 40dB)
- Unity Gain Bandwidth (180MHz typ.)
- Input Offset Voltage (7mV max.)
- Maximum Output Voltage (±1.5V typ. at $R_L = 1k\Omega$)
- Open Loop Voltage Gain (75dB typ.)
- Bipolar Technology
- Package Outline MTP5

■ PIN CONFIGURATION

NJM2711F
(Top View)

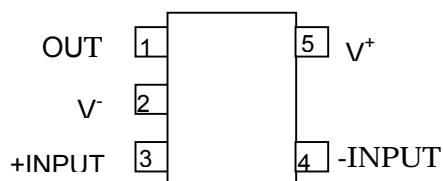

- PIN FUNCTION
1. OUTPUT
 2. V^-
 3. +INPUT
 4. -INPUT
 5. V^+

NJM2711

■ ABSOLUTE MAXIMUM RATINGS

(Ta=25°C)

PARAMETER	SYMBOL	RATINGS	UNIT
Supply Voltage	V ⁺	10	V
Differential Input Voltage	V _{ID}	±2	V
Power Dissipation	P _D	200	mW
Operating Temperature Range	T _{opr}	-40 to +85	°C
Storage Temperature Range	T _{stg}	-50 to +150	°C

■ RECOMMENDED OPERATING CONDITION

(Ta=25°C)

PARAMETER	SYMBOL	TEST CONDITION	MIN	TYP	MAX	UNIT
Operating Voltage Range	V ⁺ /V ⁻		2.0	2.5	4.5	V

■ DC CHARACTERISTICS

(V⁺/V⁻=±2.5V, Ta=25°C)

PARAMETER	SYMBOL	TEST CONDITION	MIN	TYP	MAX	UNIT
Operating Current	I _{CC}	No Signal	-	1.9	3.4	mA
Input Offset Voltage	V _{IO}		-	2.0	7.0	mV
Input Bias Current	I _B		-	2	7	μA
Input Offset Current	I _{IO}		-	350	900	nA
Open Loop Voltage Gain	A _v	R _L =2kΩ	65	75	-	dB
Input Common Mode Voltage Range	V _{ICM}		±1.3	±1.5	-	V
Common Mode Rejection	CMR	-1V ≤ V _{CM} ≤ +1V	50	60	-	dB
Supply Voltage Rejection	+SVR	2.5V ≤ V ⁺ ≤ 5V, R _L =2kΩ	50	60	-	dB
	-SVR	-5V ≤ V ⁻ ≤ -2.5V, R _L =2kΩ	50	60	-	dB
Maximum Output Voltage	V _{OM}	R _L =1kΩ	±1.2	±1.5	-	V

■ AC CHARACTERISTICS

(V⁺/V⁻=±2.5V, Ta=25°C)

PARAMETER	SYMBOL	TEST CONDITION	MIN	TYP	MAX	UNIT
Bandwidth	BW	A _v =40dB, R _f =1.98kΩ, R _L =∞ C _L =10pF	-	10	-	MHz
Unity Gain Bandwidth	f _T	A _v =40dB, R _g =20Ω, R _f =1.98kΩ R _L =∞, C _L =10pF	-	180	-	MHz
Phase Margin	φ _M	A _v =40dB, R _g =20Ω, R _f =1.98kΩ R _L =∞, C _L =10pF	-	38	-	deg
Equivalent Input Noise Voltage	V _{NI}		-	6.8	-	nV/√Hz

■ TRANSIENT CHARACTERISTICS

(V⁺/V⁻=±2.5V, Ta=25°C)

PARAMETER	SYMBOL	TEST CONDITION	MIN	TYP	MAX	UNIT
Slew Rate	+SR	A _v =6dB, R _f =1kΩ, R _g =1kΩ	-	260	-	V/μs
	-SR	R _L =∞, C _L =10pF	-	260	-	V/μs

■ Note:

non-inverting amplifier

1. The closed gain should be 6dB or higher to prevent the oscillation.
Unity gain follower application may cause the oscillation.
2. When the closed gain is lower than 20dB, use a compensation capacitor (CF: about 5pF), parallel with the feedback resistor RF to avoid oscillation.
3. Recommended feedback resistor is less than 2k-ohm to keep the flatness of the frequency response.
4. Minimize the load capacitor for the better performance.
A large load capacitor CL reduces the frequency response and causes oscillation or ringing.

inverting amplifier

1. When the closed gain is lower than 20dB, use a compensation capacitor (CF; recommended from 1pF to 5pF), parallel with the feedback resistor RF to avoid oscillation.
2. Minimize the feedback resistor to keep the frequency response and the slew rate.
(recommended about 1k-ohm)
The proper compensation capacitor CF can counteract oscillation even with a large feedback resistor RF.
3. Total load capacitance should be not more than 100pF.
The oscillation margin may be affected by the total load capacitance.

non-inverting amplifier

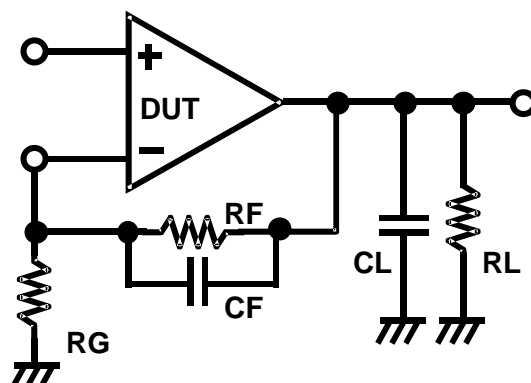

inverting amplifier

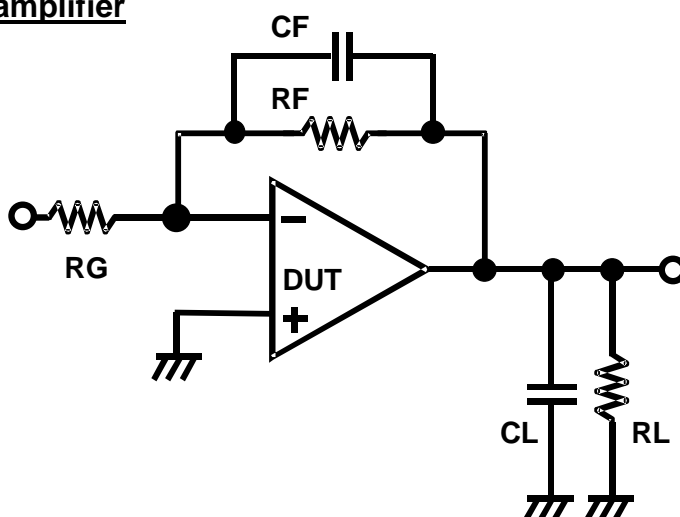

■ TYPICAL CHARACTERISTICS

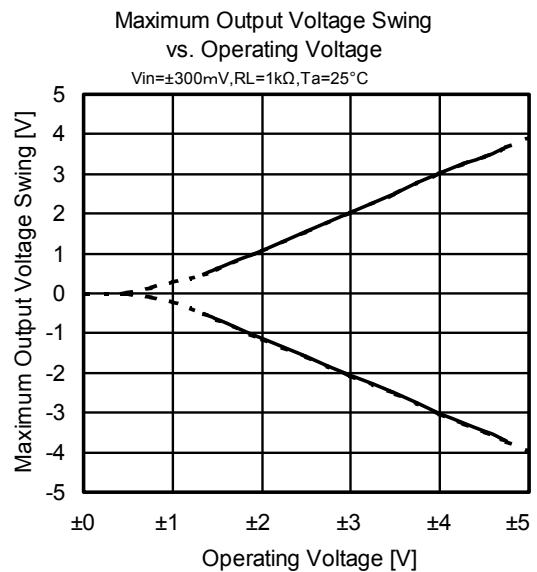
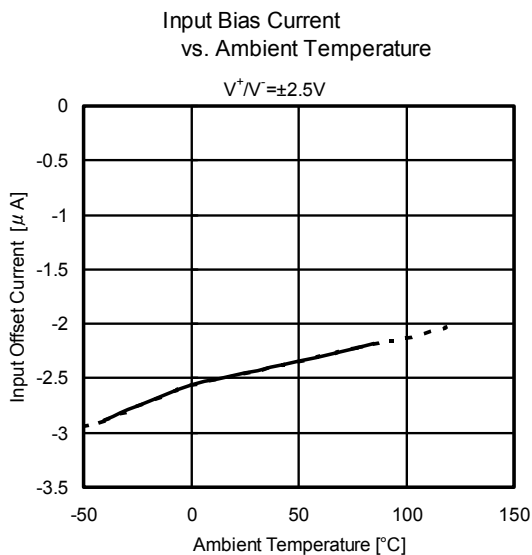
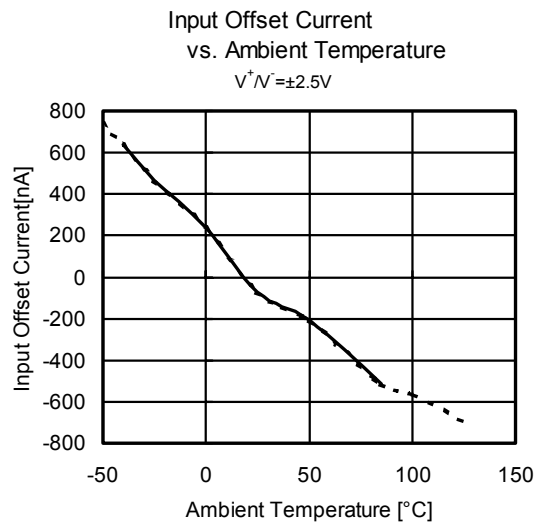
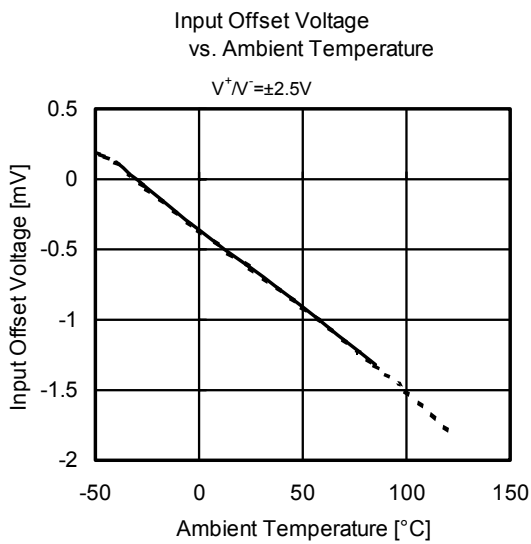
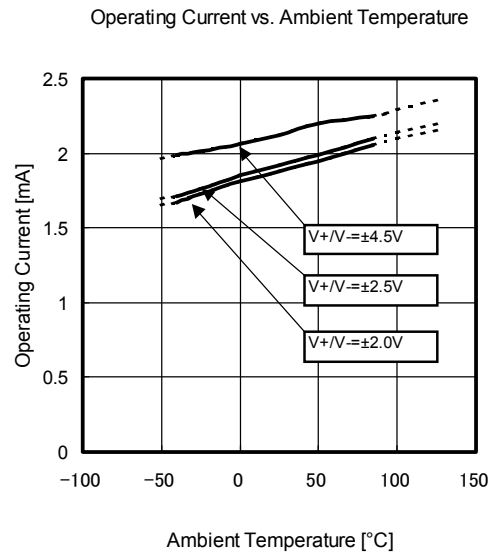
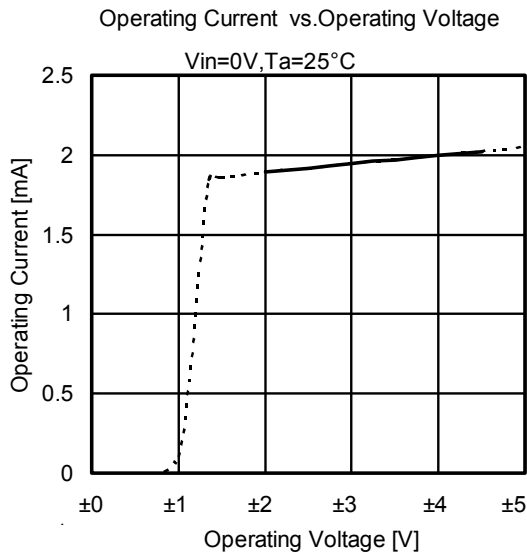

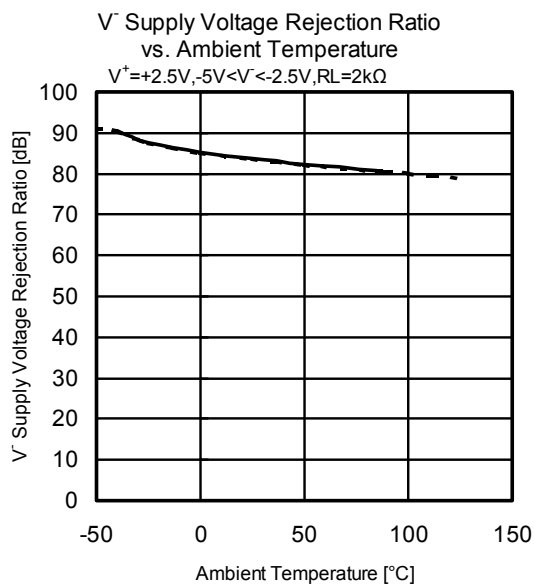
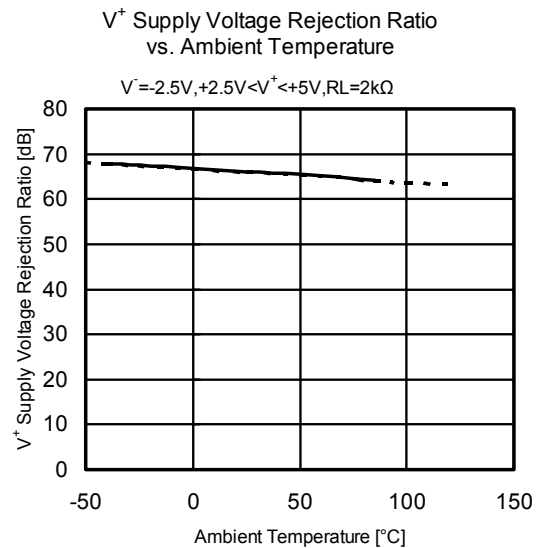
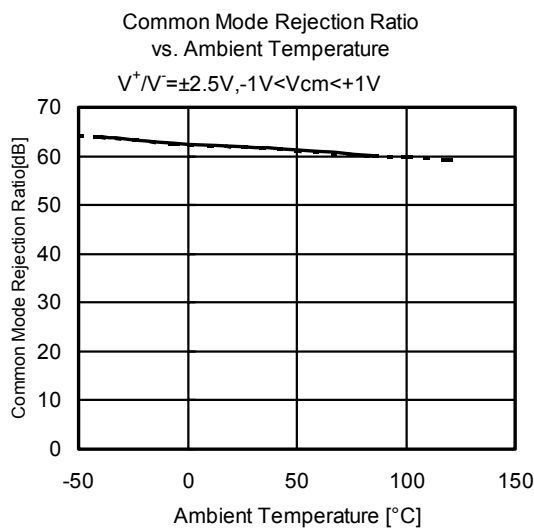
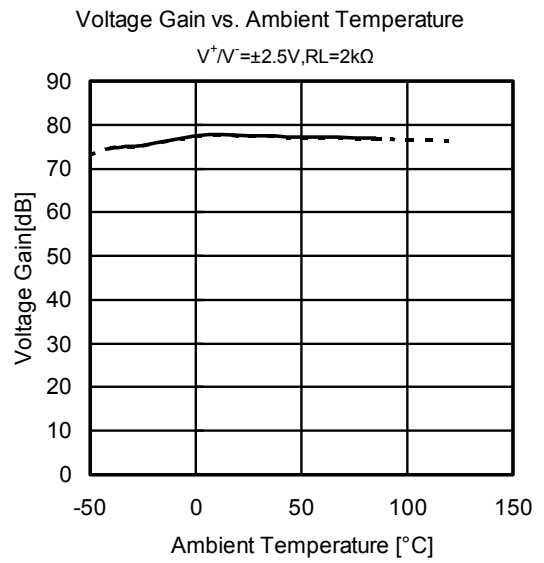
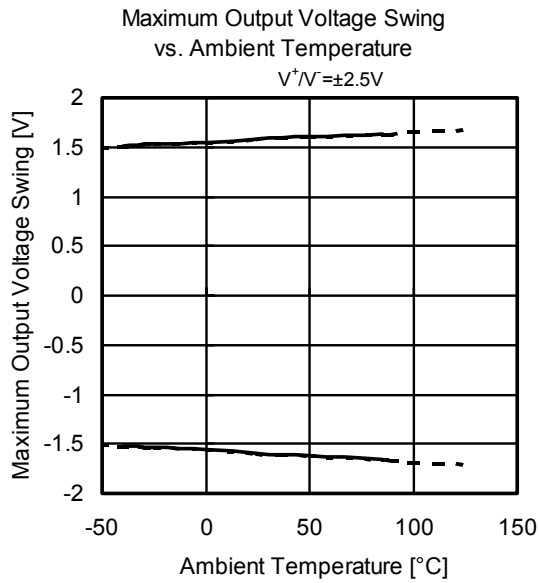

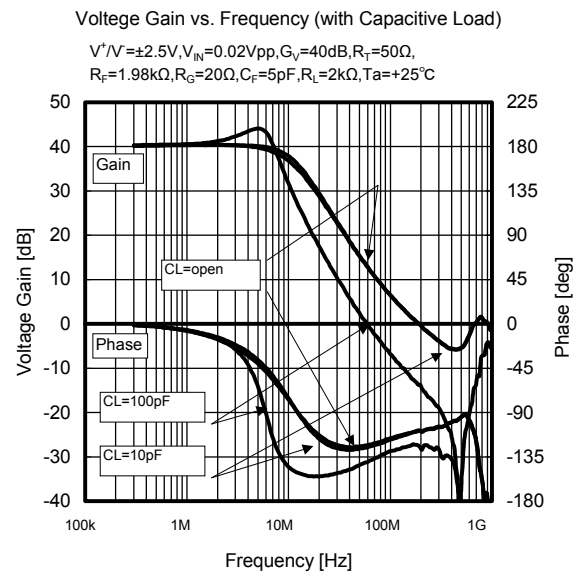
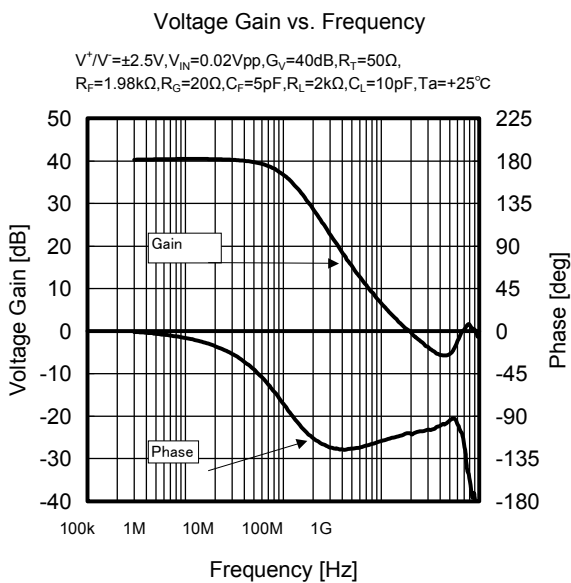
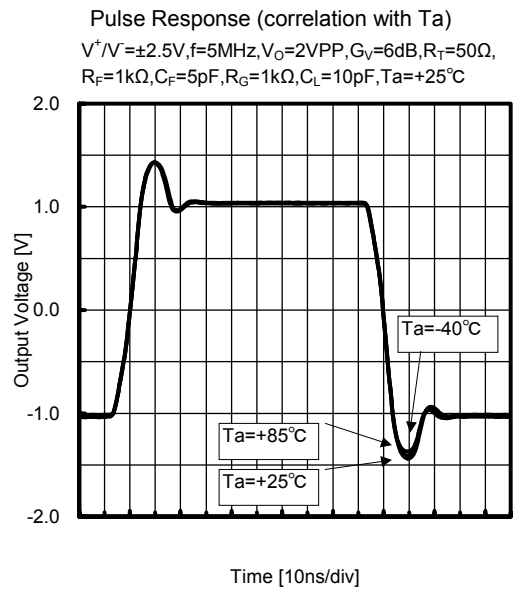
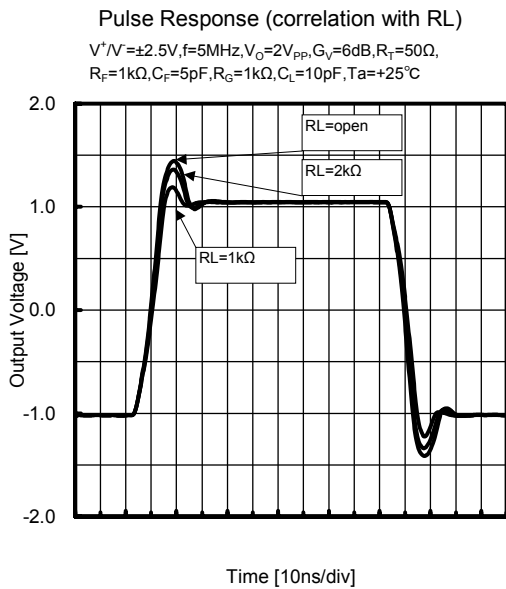
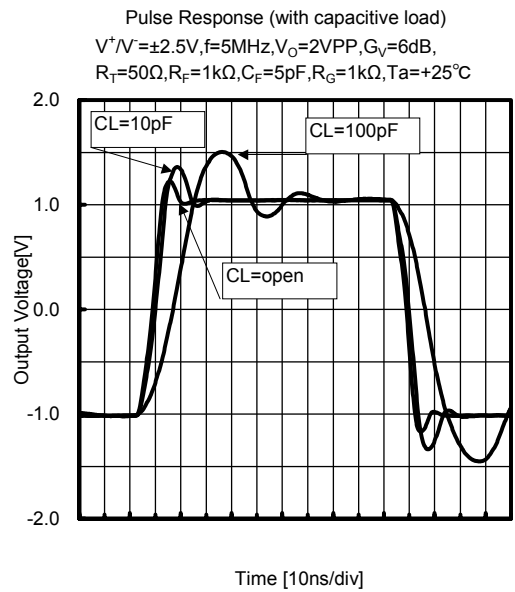
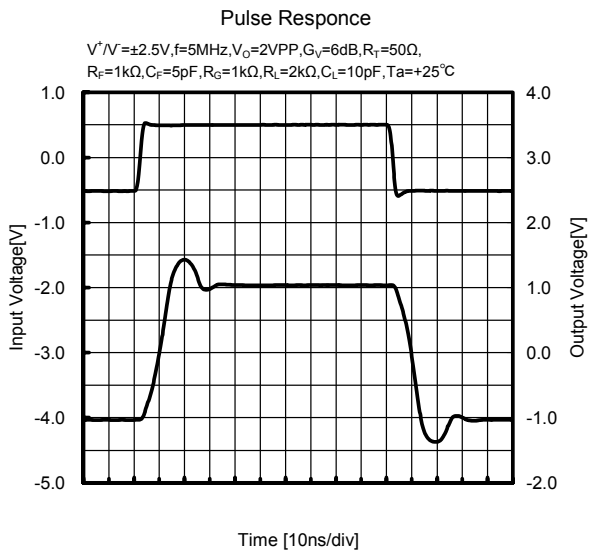

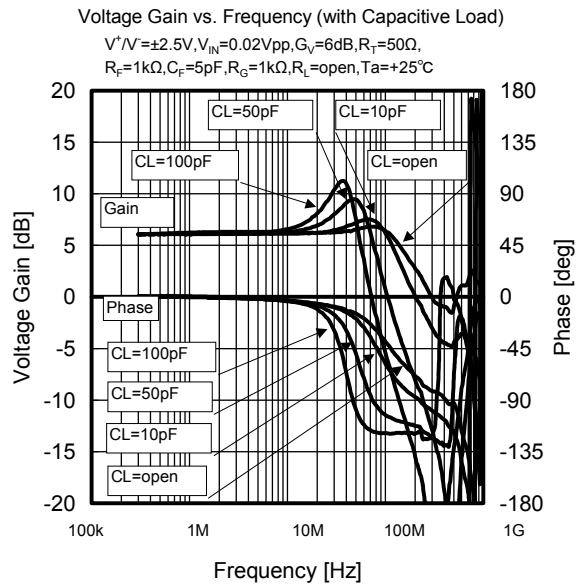
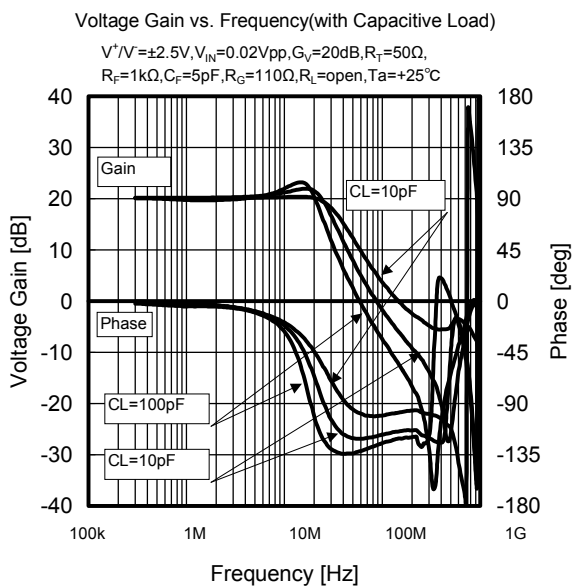
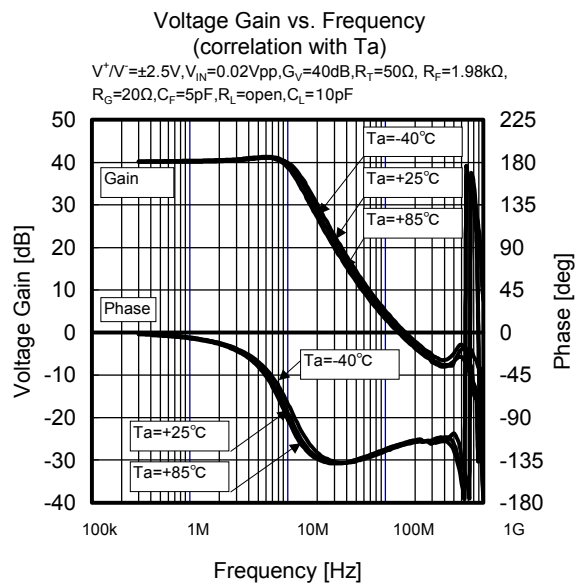
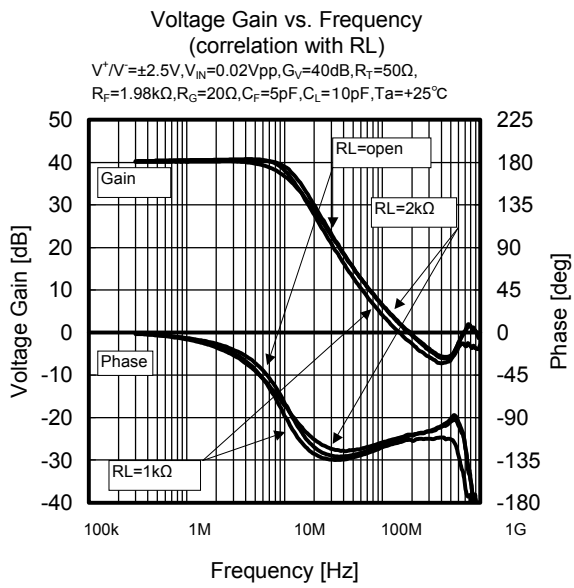

■ MEASUREMENT CIRCUIT

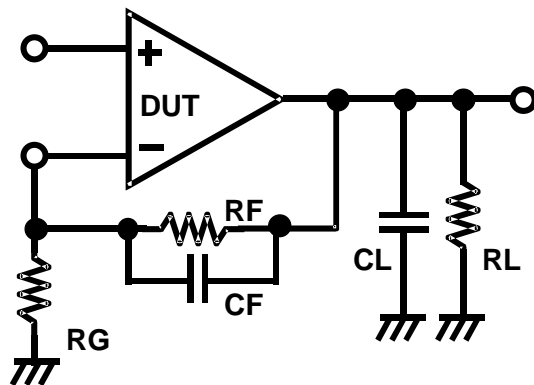

[CAUTION]
The specifications on this databook are only given for information, without any guarantee as regards either mistakes or omissions. The application circuits in this databook are described only to show representative usages of the product and not intended for the guarantee or permission of any right including the industrial rights.