

QUAD OPERATIONAL AMPLIFIER

■ GENERAL DESCRIPTION

NJM2745 is the quad operational amplifier for the audio use. Designed low noise, high gain-bandwidth, and low distortion, the NJM2745 is suitable for audio applications and active filters.

■ PACKAGE OUTLINE

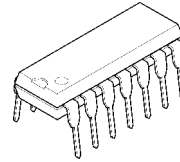

NJM2745D

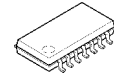

NJM2745M

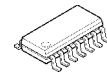

NJM2745E
(U.D.)



NJM2745V

■ FEATURES

- Operating Voltage ($\pm 2V$ to $\pm 7V$)
- Low Input Noise Voltage ($5nV/\sqrt{Hz}$ @1kHz typ.)
- Wide Gain Bandwidth Product (15MHz typ.)
- Low Distortion (0.005% typ. @ $A_v=20dB, V_o=1V_{rms}, R_L=2k\Omega, f=1kHz$)
- Slew Rate ($5V/\mu s$ typ.)
- Package Outline DIP14, EMP14, SSOP14, DMP14
- Bipolar Technology

■ PIN CONFIGURATION

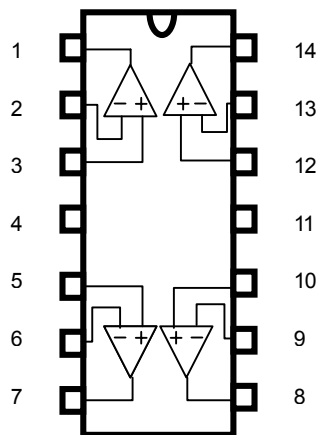

PIN ASSIGNMENT

- 1. A OUTPUT
- 2. A -INPUT
- 3. A +INPUT
- 4. V^+
- 5. B +INPUT
- 6. B -INPUT
- 7. B OUTPUT
- 8. C OUTPUT
- 9. C -INPUT
- 10. C +INPUT
- 11. V^-
- 12. D +INPUT
- 13. D -INPUT
- 14. D OUTPUT

■ EQUIVALENT CIRCUIT (1/4 Shown)

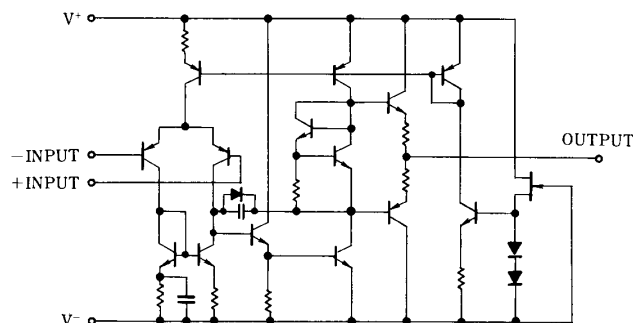

NJM2745

■ ABSOLUTE MAXIMUM RATINGS

(Ta=25°C)

PARAMETER	SYMBOL	RATINGS	UNIT
Supply Voltage	V ⁺ /V	± 7.5	V
Common mode Input Voltage	V _{IC}	± 7.5 (note 1)	V
Differential Input Voltage	V _{ID}	± 15 (note 1)	V
Power Dissipation	P _D	870(DIP14) 930(EMP14) (note 2) 700(DMP14) (note 2) 570(SSOP14) (note 2)	mW
Output Current	I _O	± 50	mA
Operating Temperature Range	T _{opr}	-40~+85	°C
Storage Temperature Range	T _{stg}	-40~+125	°C

(note 1)For supply voltages less than ±7.5 V, the absolute maximum input voltage is equal to the supply voltage.

(note 2)Mounted on the EIA/JEDEC standard board (76.2 ×114.3 ×1.6mm, two layer FR-4).

■ RECOMMENDED OPERATING CONDITION

(Ta=25°C)

PARAMETER	SYMBOL	MIN.	TYP.	MAX.	UNIT
Supply Voltage	V ⁺ /V	±2	-	±7	V

■ DC CHARACTERISTICS

(Ta=25°C, V⁺/V=±4.5V)

PARAMETER	SYMBOL	TEST CONDITION	MIN.	TYP.	MAX.	UNIT
Operating Current	I _{CC}		-	12	18	mA
Input Offset Voltage	V _{IO}	R _S ≤10kΩ	-	0.3	3	mV
Input Bias Current	I _B		-	100	500	nA
Input Offset Current	I _{IO}		-	5	200	nA
Large Signal Voltage Gain	A _V	R _L ≥2kΩ, V _O =±1.5V	90	110	-	dB
Common Mode Rejection Ratio	CMR	R _S ≤10kΩ, -2.5V≤V _{IC} ≤+2.5V	70	110	-	dB
Supply Voltage Rejection Ratio	SVR	R _S ≤10kΩ, V ⁺ /V=±2V to ±7V	80	110	-	dB
Output Voltage Swing	V _{OM}	R _L ≥2kΩ	±2.5	±3	-	V
Input Common Mode Voltage Range	V _{ICM}	CMR≥70dB	-2.5	-	+2.5	V

■ AC CHARACTERISTICS

(Ta=25°C, V⁺/V=±4.5V)

PARAMETER	SYMBOL	TEST CONDITION	MIN.	TYP.	MAX.	UNIT
Gain Bandwidth Product	GB	f=10kHz	-	15	-	MHz
Total Harmonic Distortion	THD	A _V =20dB, V _O =1Vrms, R _L =2kΩ, f=1kHz	-	0.005	-	%
Input Noise Voltage	V _{NI}	R _S =0Ω	-	5	-	nV/√Hz

■ TRANSIENT CHARACTERISTICS

(Ta=25°C, V⁺/V=±4.5V)

PARAMETER	SYMBOL	TEST CONDITION	MIN.	TYP.	MAX.	UNIT
Slew Rate	SR	R _L ≥2kΩ	-	5	-	V/μs

■ TYPICAL CHARACTERISTICS

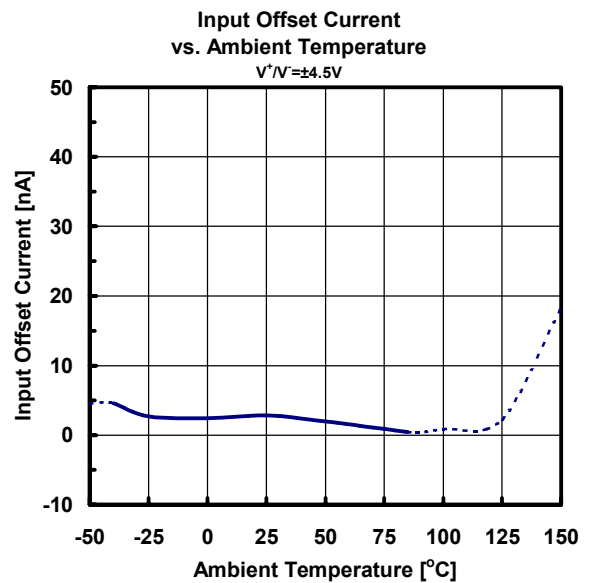
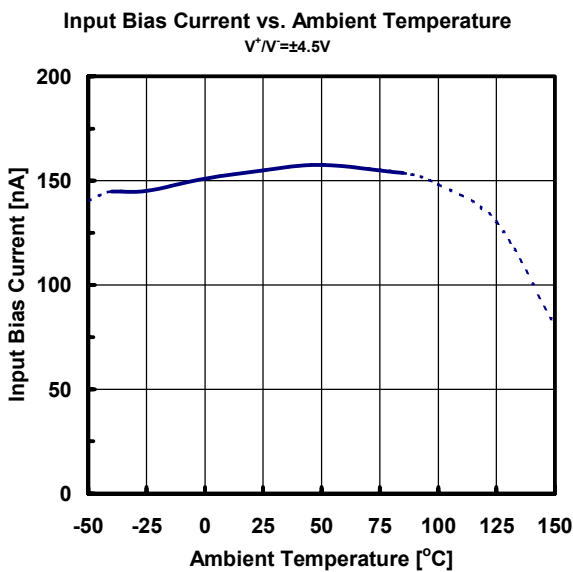
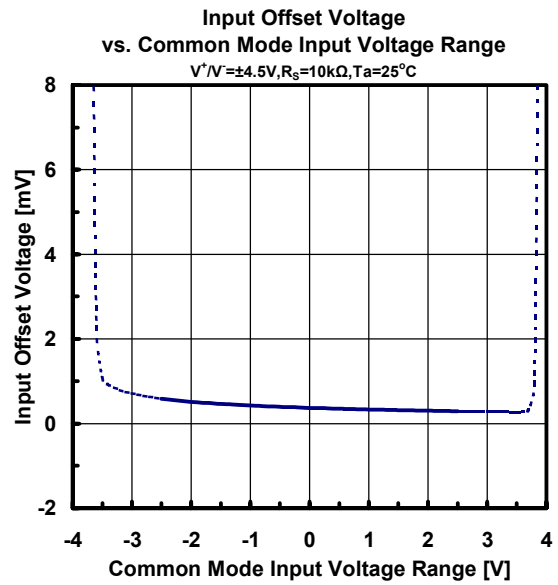
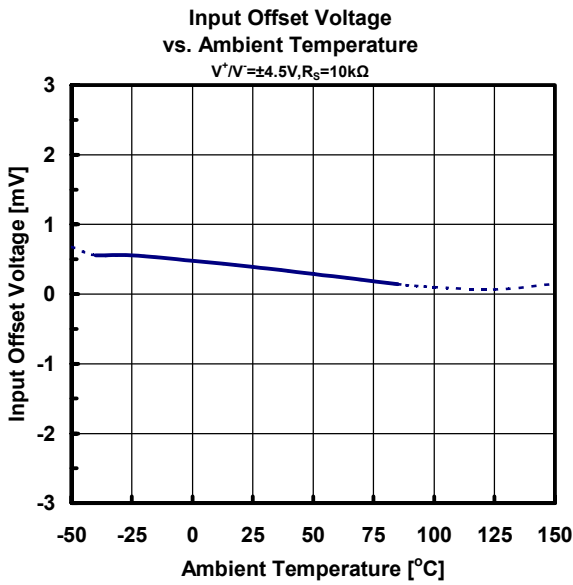
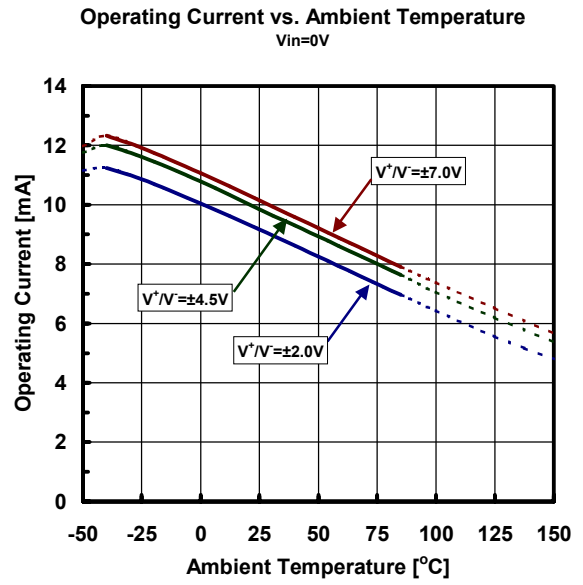
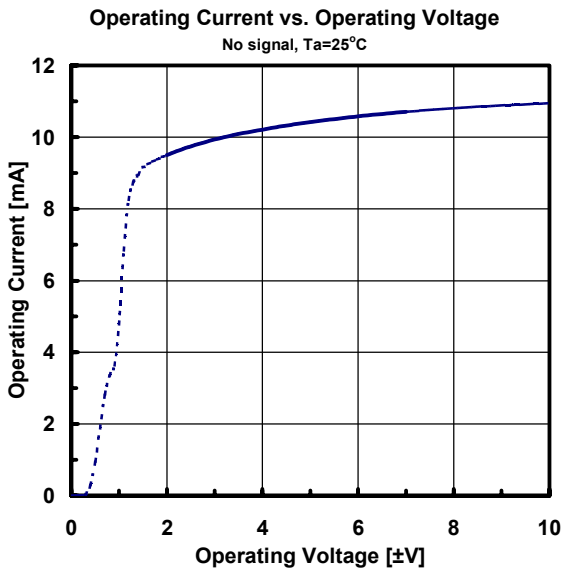

■ TYPICAL CHARACTERISTICS

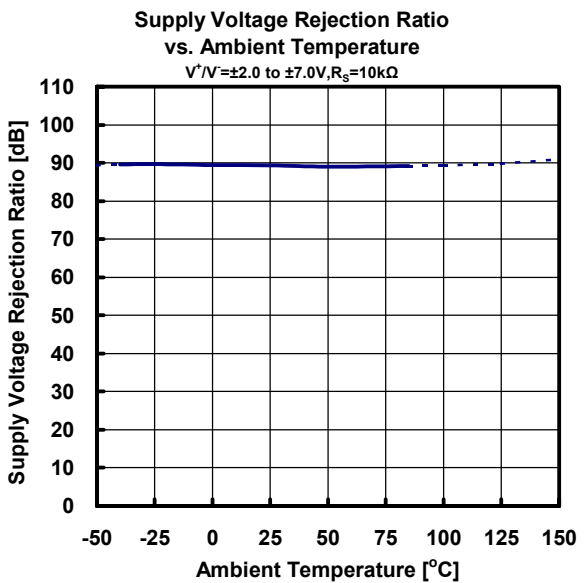
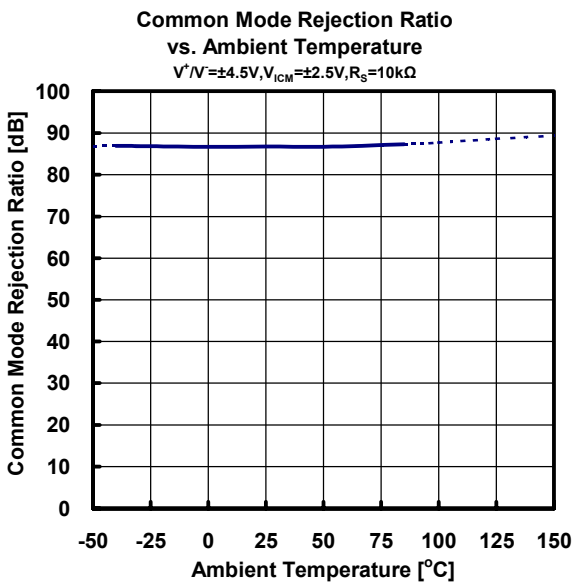
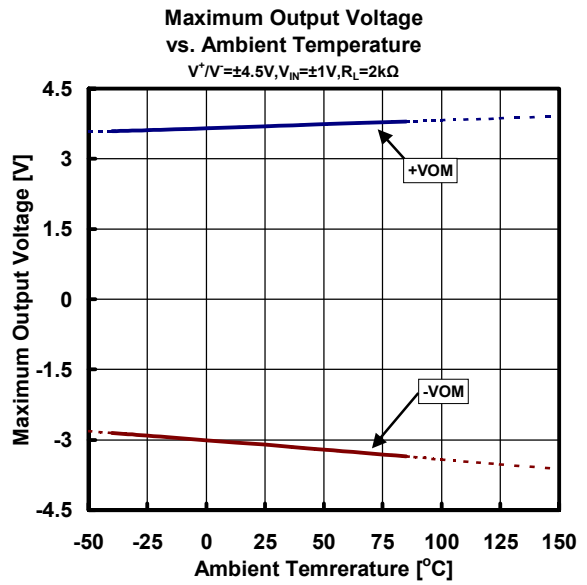
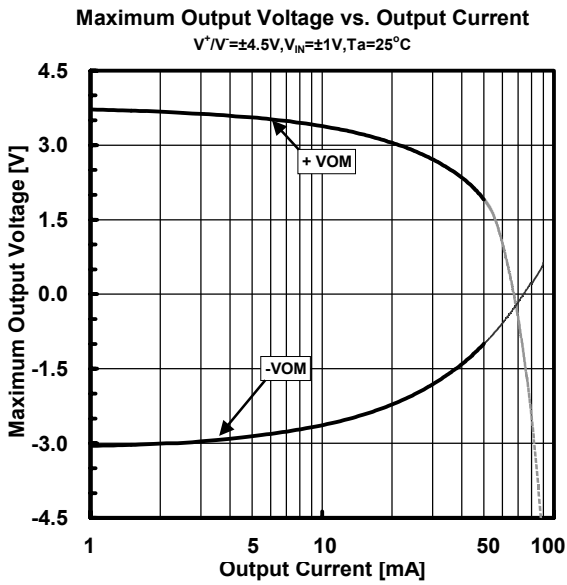
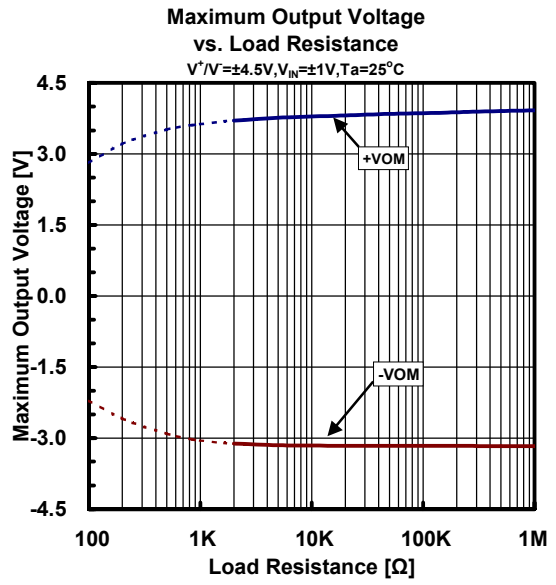
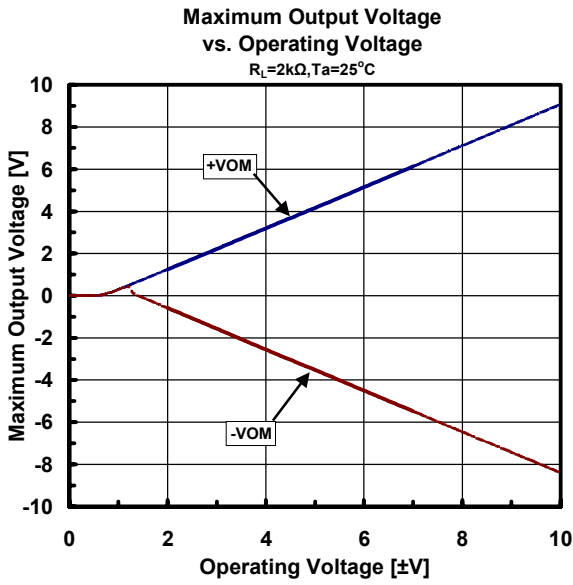

TYPICAL CHARACTERISTICS

Voltage Gain vs. Ambient Temperature
 $V^+ / V^- = \pm 4.5V, V_{out} = \pm 1.5V, R_L = 2k\Omega$

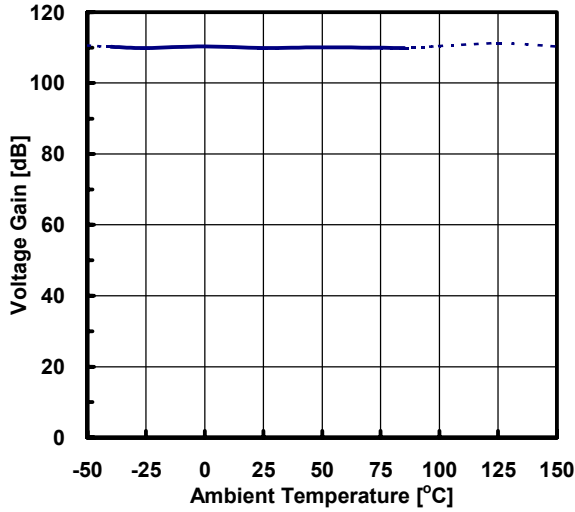

Equivalent Input Noise Voltage vs. Frequency
 $V^+ / V^- = \pm 4.5V, G_v = 60dB, R_s = 50\Omega, R_L = 10k\Omega, T_a = 25^\circ C$

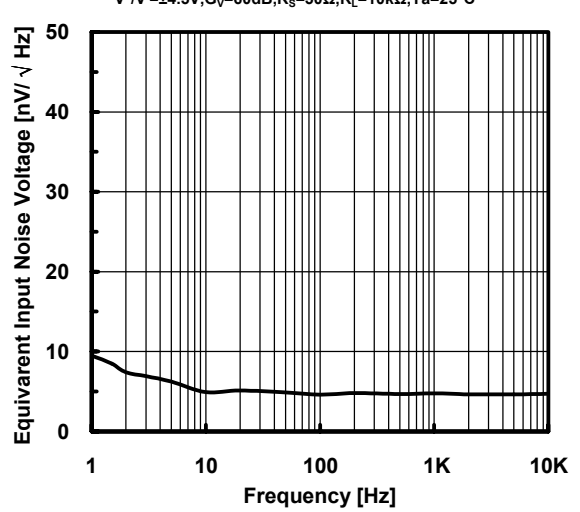

THD+N vs. Output Voltage
 $V^+ / V^- = \pm 4.5V, G_v = 20dB, R_L = 2k\Omega, T_a = 25^\circ C$

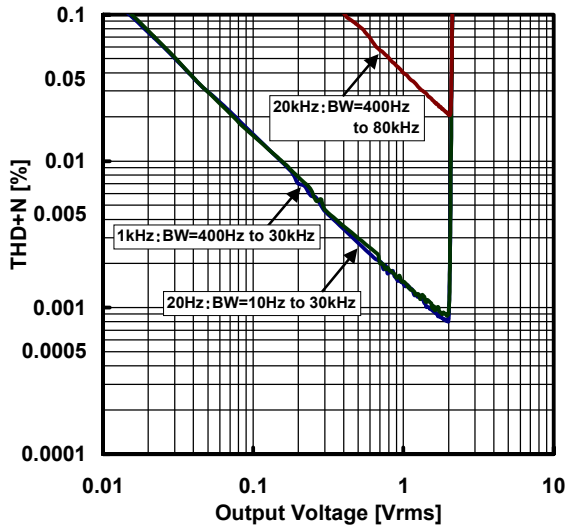

Voltage Gain/Phase vs. Frequency
 (Correlation with Capacitive load)
 $V^+ / V^- = \pm 4.5V, G_v = 40dB, R_L = 2k\Omega, T_a = 25^\circ C$

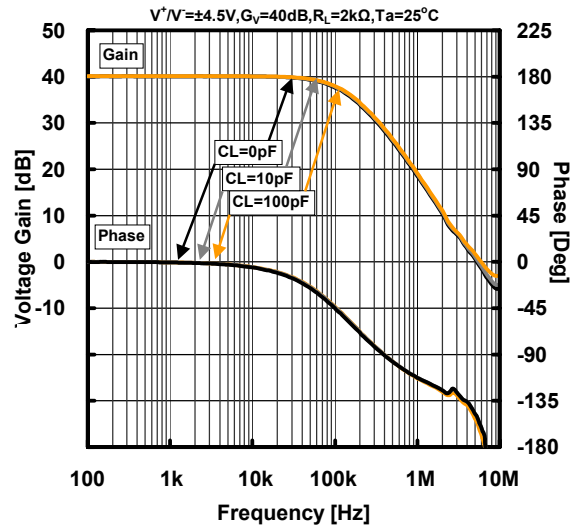

Voltage Gain/Phase vs. Frequency
 (Correlation with T_a)
 $V^+ / V^- = \pm 4.5V, G_v = 40dB, R_L = 2k\Omega, C_L = 10pF$

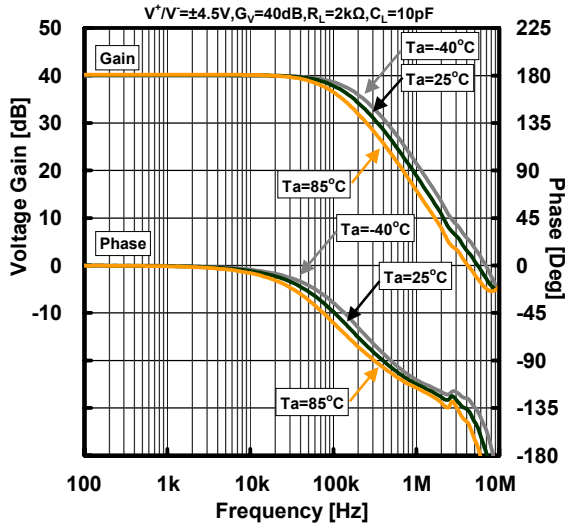

TYPICAL CHARACTERISTICS

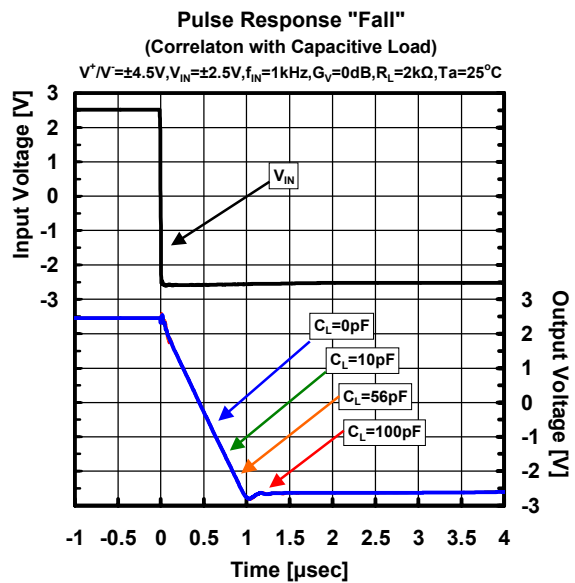
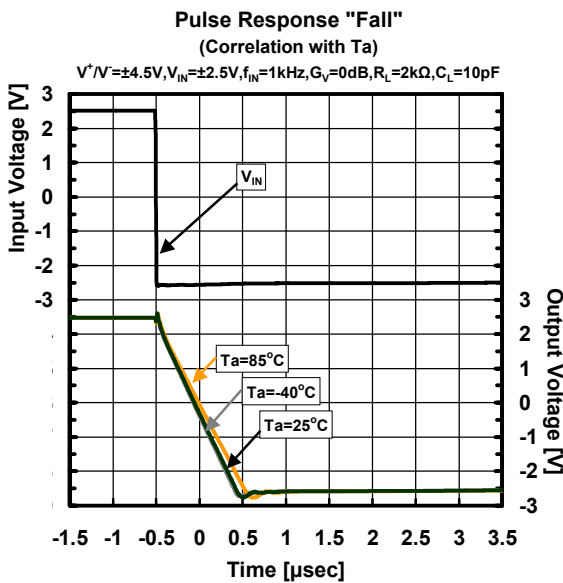
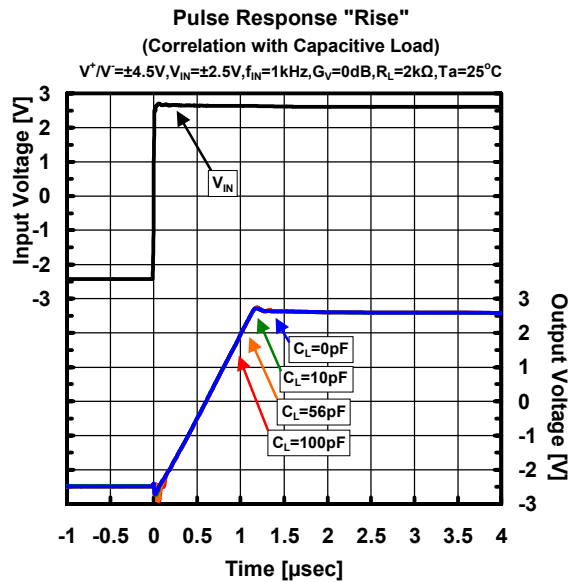
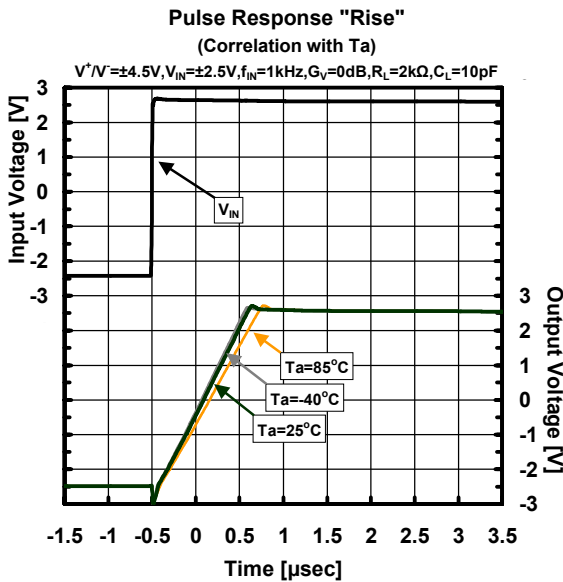
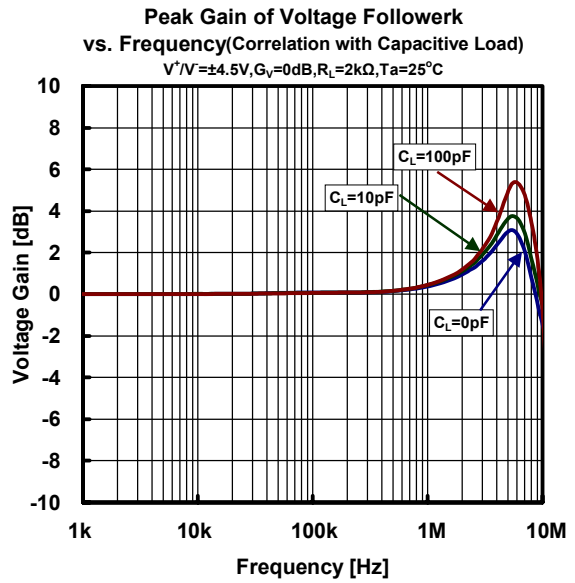
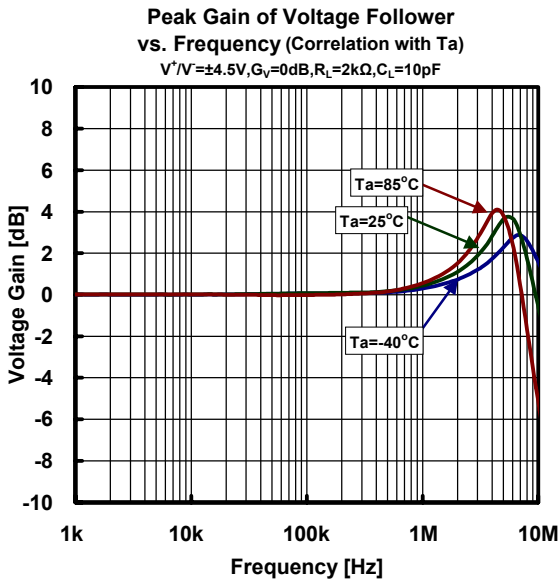

■ NOTE

[CAUTION]

The specifications on this databook are only given for information, without any guarantee as regards either mistakes or omissions. The application circuits in this databook are described only to show representative usages of the product and not intended for the guarantee or permission of any right including the industrial rights.