

ADJUSTABLE PRECISION SHUNT REGULATOR

■ GENERAL DESCRIPTION

The NJM431 is a 3 terminal adjustable shunt regulator. The output voltage may be set to any value between V_{REF} (about 2.5V) and 36V by two resistors. Output circuitry shows a sharp turn-on characteristics. Applications include shunt regulators, series regulators for small power and isolation regulators with photo couplers.

■ PACKAGE OUTLINE

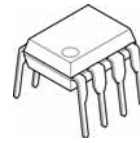

NJM431D (DIP8)

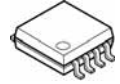

NJM431M (DMP8)



NJM431U (SOT-89)

■ FEATURES

- Operating Voltage ($V_{KA} = V_{REF}$ to 36V)
- Fast Turn-On Response
- Cathode Current (1mA to 100mA)
- Low Dynamic Output Impedance (0.2Ωtyp.)
- Load Regulation typically (0.1%)
- Package Outline DIP8, DMP8, SOT-89
- Bipolar Technology

■ PIN CONFIGURATION

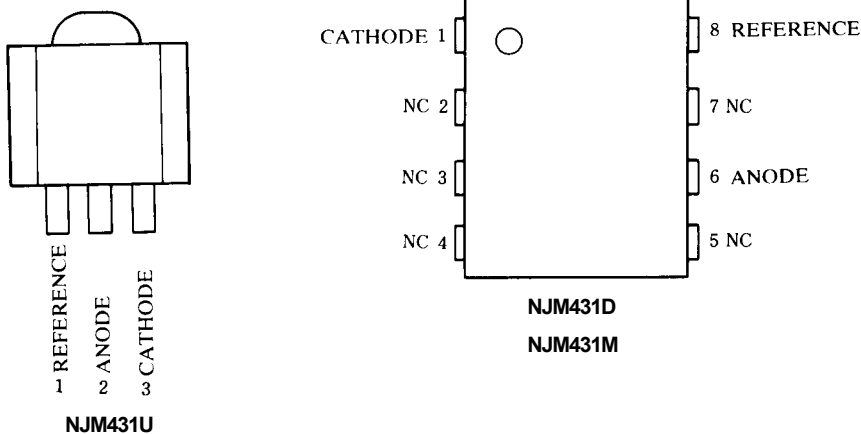

■ EQUIVALENT CIRCUIT

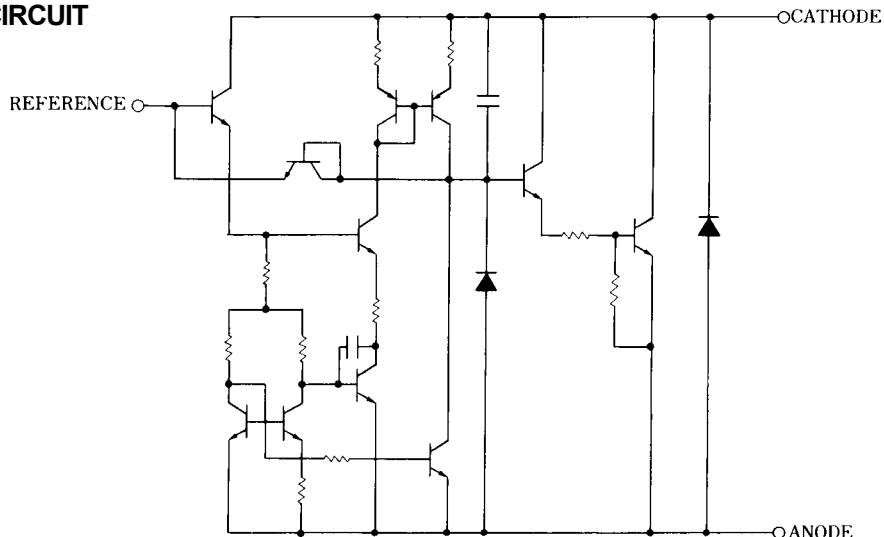

NJM431

■ BLOCK DIAGRAM

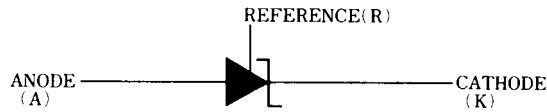

■ ABSOLUTE MAXIMUM RATINGS

($T_a=25^\circ\text{C}$)

| PARAMETER | SYMBOL | RATINGS | UNIT |
|----------------------------|-----------|---|------------------|
| Cathode Voltage (note) | V_{KA} | 37 | V |
| Continuous Cathode Current | I_K | -100 to 150 | mA |
| Reference Input Current | I_{REF} | -0.05 to 10 | mA |
| Power Dissipation | P_D | (DIP8) 700 (DMP8) 300 (SOT89) 350 | mW mW mW |
| Operating Temperature | T_{opr} | -40 to +85 | $^\circ\text{C}$ |
| Storage Temperature Range | T_{stg} | -40 to +125 | $^\circ\text{C}$ |

(note) Unless specified, all voltage value are with respect to the anode terminal.

■ RECOMMENDED OPERATING CONDITIONS

| PARAMETER | SYMBOL | MIN. | TYP. | MAX. | UNIT |
|-----------------|----------|-----------|------|------|------|
| Cathode Voltage | V_{KA} | V_{REF} | - | 36 | V |
| Cathode Current | I_K | 1 | - | 100 | mA |

■ ELECTRICAL CHARACTERISTICS ($T_a=25^\circ\text{C}$)

| PARAMETER | SYMBOL | TEST CONDITION | MIN. | TYP. | MAX. | UNIT | |
|---|--|--|---|------|------|---------------|------|
| Reference Voltage | V_{REF} | $V_{KA} = V_{REF}$, $I_K = 10\text{mA}$ (note 1) | 2440 | 2495 | 2550 | mV | |
| Reference Voltage Change (Full Oper. Temp. Range) | V_{REF} (dev) | $V_{KA} = V_{REF}$, $I_K = 10\text{mA}$ (note 1) $T_a = -20^\circ\text{C}$ to $+85^\circ\text{C}$ | - | 8 | 17 | mV | |
| Reference Voltage Change vs. Cathode Voltage Change | $\frac{\Delta V_{REF}}{\Delta V_{KA}}$ | $I_K = 10\text{mA}$ (note 2) | $\Delta V_{KA} = 10\text{V} - V_{REF}$ | - | -1.4 | -2.7 | mV/V |
| | | | $\Delta V_{KA} = 36\text{V} - 10\text{V}$ | - | -1 | -2 | mV/V |
| Reference Input Current | I_{REF} | $I_K = 10\text{mA}$, $R_1 = 10\text{k}\Omega$, $R_2 = \infty$ (note 2) | - | 2 | 4 | μA | |
| Reference Input Current Change (Full Oper. Temp. Range) | I_{REF} (dev) | $I_K = 10\text{mA}$, $R_1 = 10\text{k}\Omega$, $R_2 = \infty$ (note 2) $T_a = -20^\circ\text{C}$ to $+85^\circ\text{C}$ | - | 0.4 | 1.2 | μA | |
| Minimum Input Current | I_{MIN} | $V_{KA} = V_{REF}$ (note 1) | - | 0.4 | 1.0 | mA | |
| Cathode Current (Off Cond.) | I_{OFF} | $V_{KA} = 36\text{V}$, $V_{REF} = 0$ (note 3) | - | 0.1 | 1.0 | μA | |
| Dynamic Impedance | $ Z_{KA} $ | $V_{KA} = V_{REF}$, $I_K = 1\text{mA}$ to 100mA , $f \leq 1\text{kHz}$ (note 1) | - | 0.2 | 0.5 | Ω | |

(note 1) TEST CIRCUIT (Fig. 1)

(note 2) TEST CIRCUIT (Fig. 2)

(note 3) TEST CIRCUIT (Fig. 3)

■ TEST CIRCUITS

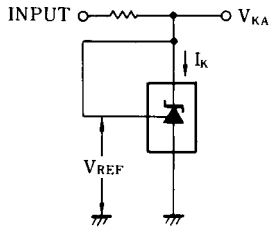

1. $V_{KA} = V_{REF}$
 $V_O = V_{KA} = V_{REF}$

(Fig. 1)

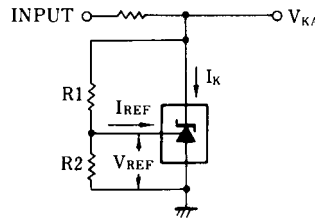

2. $V_{KA} > V_{REF}$
 $V_O = V_{KA} = V_{REF} \left(1 + \frac{R1}{R2}\right) + I_{REF} \cdot R1$

(Fig. 2)

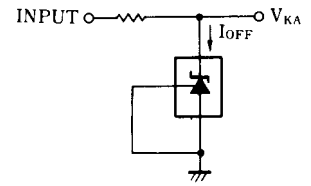

3. I_{OFF}

(Fig. 3)

■ TYPICAL APPLICATION

(1) Shunt Regulator

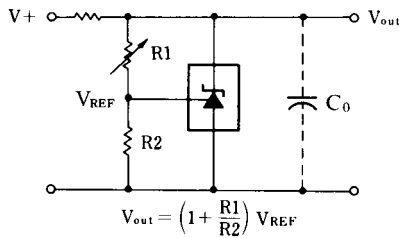

(3) Output Control of a Three-Terminal fixed Regulator

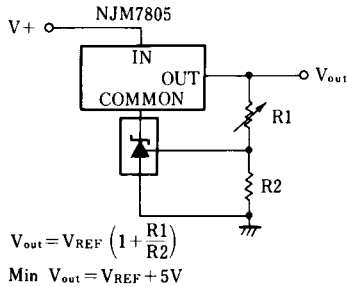

(2) Series Regulator

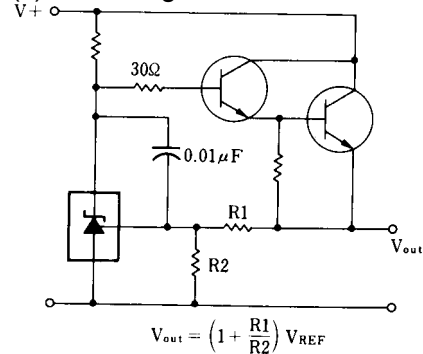

(4) Constant Current Source

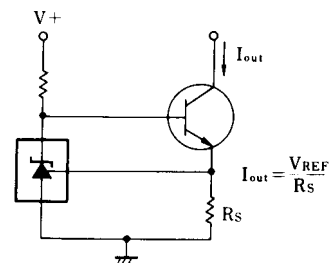

■ POWER DISSIPATION VS. AMBIENT TEMPERATURE

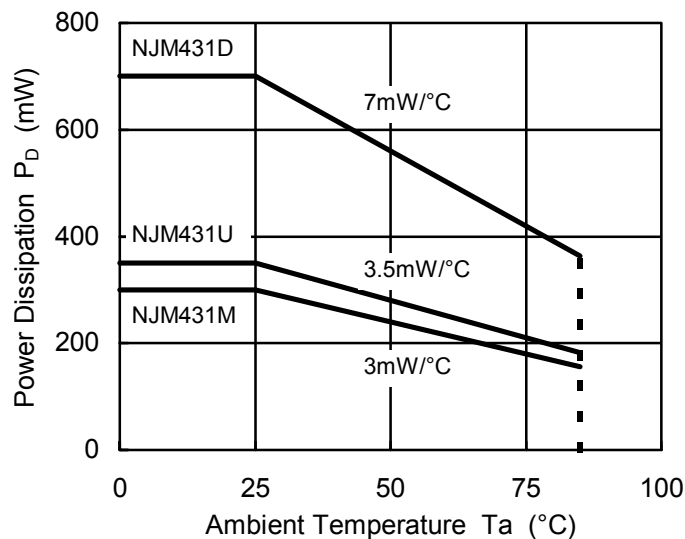

■ TYPICAL CHARACTERISTICS

Reference Voltage

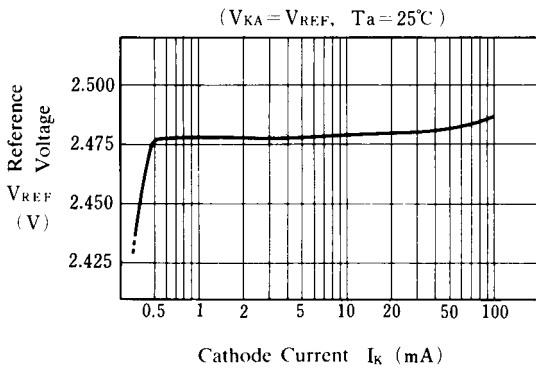

Reference Voltage

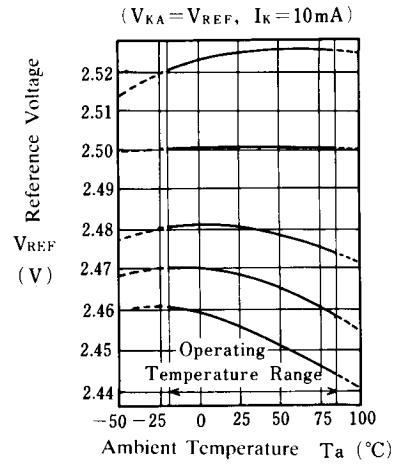

Reference Input Current

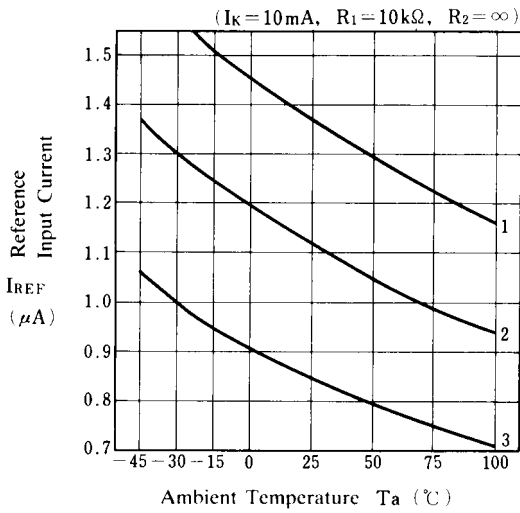

| $V_{REF}(\text{dev})$ | ($T_a = -20 \text{ to } 25^\circ\text{C}$) | ($T_a = 25 \text{ to } 85^\circ\text{C}$) | ($T_a = 25^\circ\text{C}$) |
|-----------------------|--|---|------------------------------|
| No. 1 | +5mV | +1mV | 2525mV |
| No. 2 | 0mV | 0mV | 2501mV |
| No. 3 | 0mV | -6mV | 2481mV |
| No. 4 | -2mV | -9mV | 2468mV |
| No. 5 | -5mV | -12mV | 2456mV |

$I_{REF}(\text{dev})$

- No.1 $-0.38\mu\text{A}$
- No.2 $-0.27\mu\text{A}$
- No.3 $-0.21\mu\text{A}$

Reference Voltage

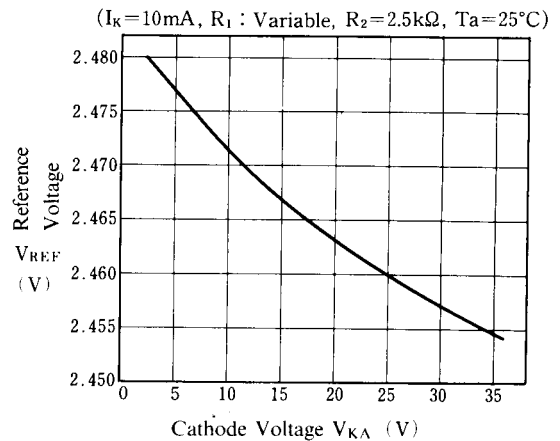

Safety Operating Boundary Condition

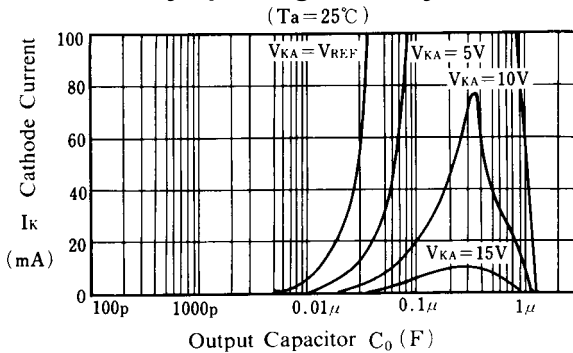

Dynamic Impedance

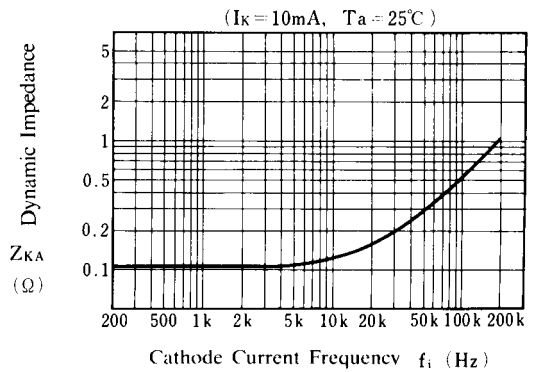

Note) Oscillation might occur while operating within the range of safety curve. So that, it is necessary to make ample margins by taking considerations of fluctuation of the device.

[CAUTION]

The specifications on this databook are only given for information, without any guarantee as regards either mistakes or omissions. The application circuits in this databook are described only to show representative usages of the product and not intended for the guarantee or permission of any right including the industrial rights.