

DUAL OPERATIONAL AMPLIFIER

■ GENERAL DESCRIPTION

NJM4580 is the dual operational amplifier, specially designed for improving the tone control, which is most suitable for the audio application.

Featuring noiseless, higher gain bandwidth, high output current and low distortion ratio, and it is most suitable not only for acoustic electronic parts of audio pre-amp and active filter, but also for the industrial measurement tools. It is also suitable for the head phone amp at higher output current, and further more, it can be applied for the handy type set operational amplifier of general purpose in application of low voltage single supply type which is properly biased of the low voltage source.

■ FEATURES

- Operating Voltage ($\pm 2V \sim \pm 18V$)
- Low Input Noise Voltage ($0.8\mu V_{rms}$ typ.)
- Wide Gain Bandwidth Product ($15MHz$ typ.)
- Low Distortion (0.0005% typ.)
- Slew Rate ($5V/\mu s$ typ.)
- Package Outline DIP8, SIP8, EMP8, SSOP8, DMP8
- Bipolar Technology

■ PACKAGE OUTLINE

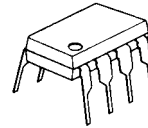

NJM4580D

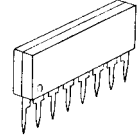

NJM4580L



NJM4580E



NJM4580V

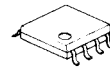

NJM4580M

■ PIN CONFIGURATION

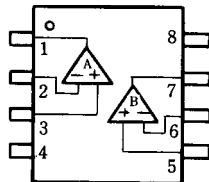

NJM4580D, NJM4580E
NJM4580M, NJM4580V

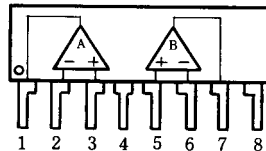

NJM4580L

PIN FUNCTION

- 1. A OUTPUT
- 2. A -INPUT
- 3. A +INPUT
- 4. V^-
- 5. B +INPUT
- 6. B -INPUT
- 7. B OUTPUT
- 8. V^+

■ EQUIVALENT CIRCUIT (1/2 Shown)

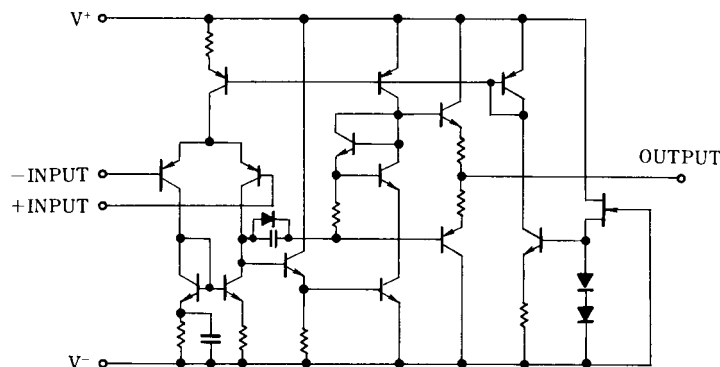

NJM4580

■ ABSOLUTE MAXIMUM RATINGS

(Ta=25°C)

PARAMETER	SYMBOL	RATINGS	UNIT
Supply Voltage	V^+V^-	± 18	V
Input Voltage	V_{IC}	± 15 (note)	V
Differential Input Voltage	V_{ID}	± 30 (note)	V
Output Current	I_o	± 50	mA
Power Dissipation	P_D	(DIP8) 800 (SIP8) 800 (DMP8) 300 (EMP8) 300 (SSOP8) 250	mW
Operating Temperature Range	T_{opr}	-40~+85	°C
Storage Temperature Range	T_{stg}	-40~+125	°C

■ ELECTRICAL CHARACTERISTICS

(Ta=25°C, $V^+V^- = \pm 15V$)

PARAMETER	SYMBOL	TEST CONDITION	MIN.	TYP.	MAX.	UNIT
Input Offset Voltage	V_{IO}	$R_S \leq 10k\Omega$	-	0.5	3	mV
Input Offset Current	I_{IO}		-	5	200	nA
Input Bias Current	I_B		-	100	500	nA
Large Signal Voltage Gain	A_V	$R_L \geq 2k\Omega, V_O = \pm 10V$	90	110	-	dB
Output Voltage Swing	V_{OM}	$R_L \geq 2k\Omega$	± 12	± 13.5	-	V
Input Common Mode Voltage Range	V_{ICM}		± 12	± 13.5	-	V
Common Mode Rejection Ratio	CMR	$R_S \leq 10k\Omega$	80	110	-	dB
Supply Voltage Rejection Ratio	SVR	$R_S \leq 10k\Omega$	80	110	-	dB
Operating Current	I_{CC}		-	6	9	mA
Slew Rate	SR	$R_L \geq 2k\Omega$	-	5	-	V/ μ s
Gain Bandwidth Product	GB	$f = 10kHz$	-	15	-	MHz
Total Harmonic Distortion	THD	$A_V = 20dB, V_O = 5V, R_L = 2k\Omega, f = 1kHz$	-	0.0005	-	%
Input Noise Voltage	V_{NI}	RIAA, $R_S = 2.2k\Omega, 30kHz$ LPF	-	0.8	-	μ Vrms

■ TYPICAL CHARACTERISTICS

Maximum Output Voltage Swing vs. Load Resistance

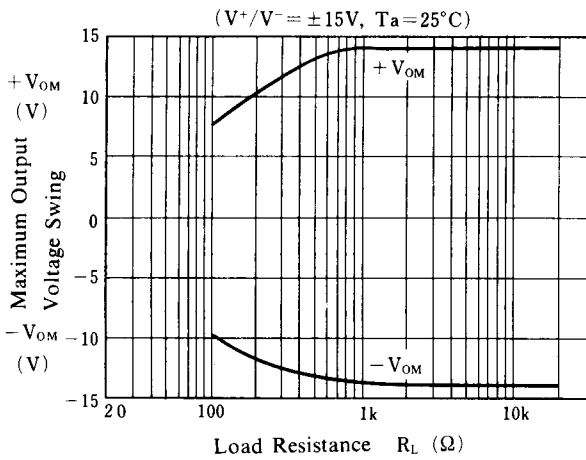

Maximum Output Voltage Swing vs. Frequency

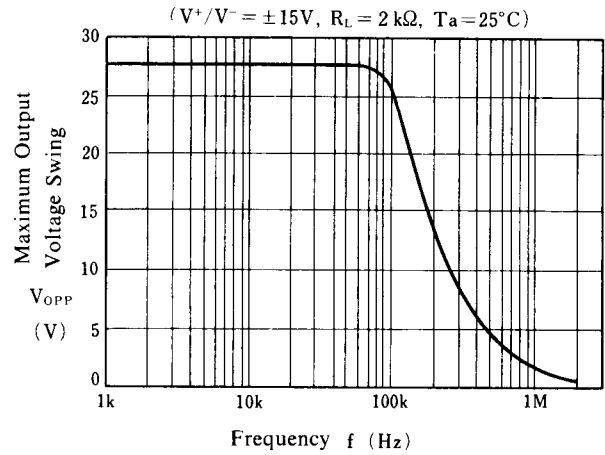

Output Voltage Swing vs. Output Current

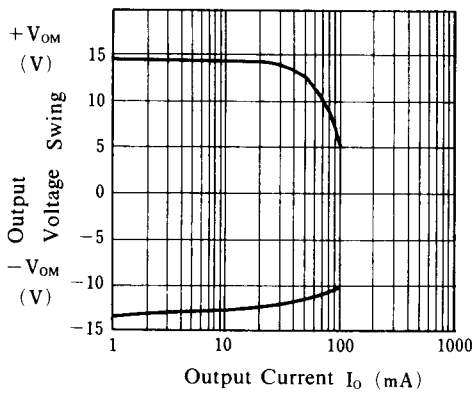

Equivalent Input Noise Voltage vs. Frequency

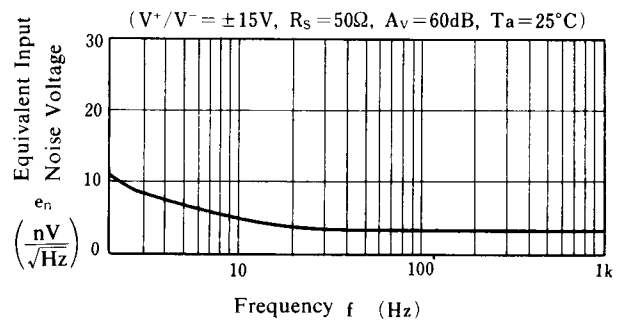

Operating Current vs. Temperature

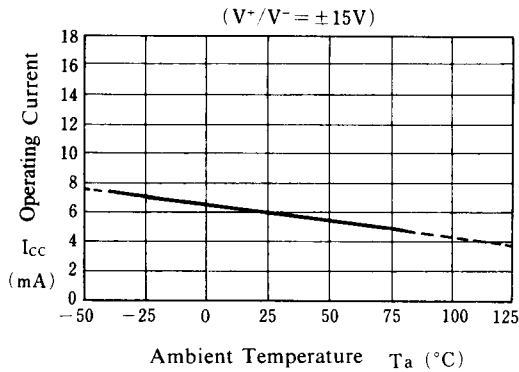

Output Voltage Swing vs. Temperature

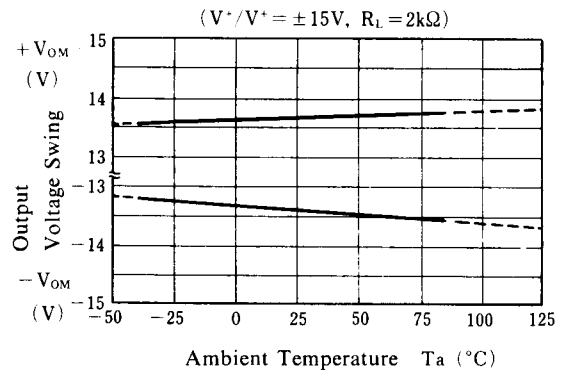

■ TYPICAL CHARACTERISTICS

Input Offset Voltage vs. Temperature

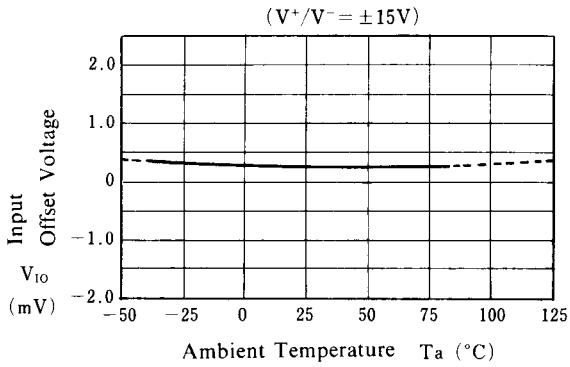

Input Bias Current vs. Temperature

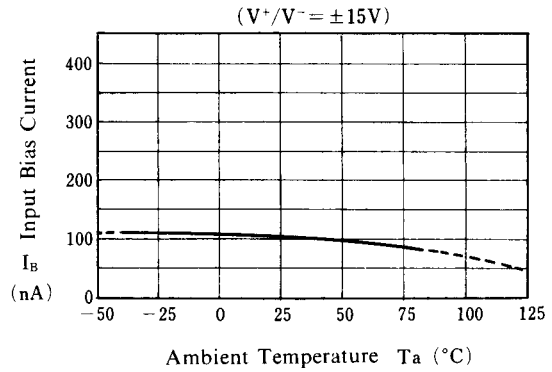

Maximum Output Voltage Swing vs. Operating Voltage

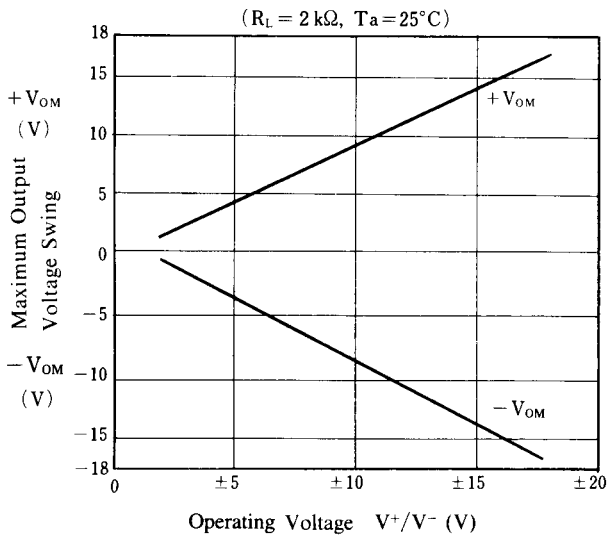

Operating Current vs. Operating Voltage

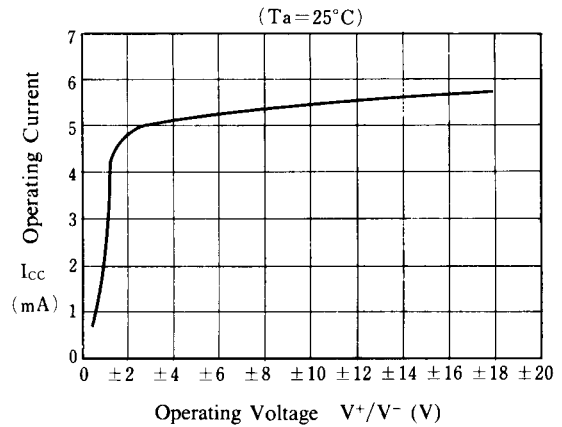

Total Harmonic Distortion vs. Output Voltage

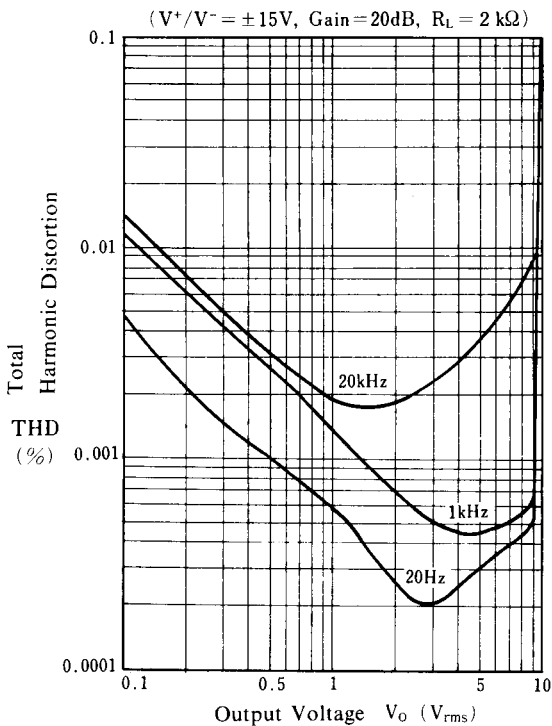

Voltage Gain, Phase vs. Frequency

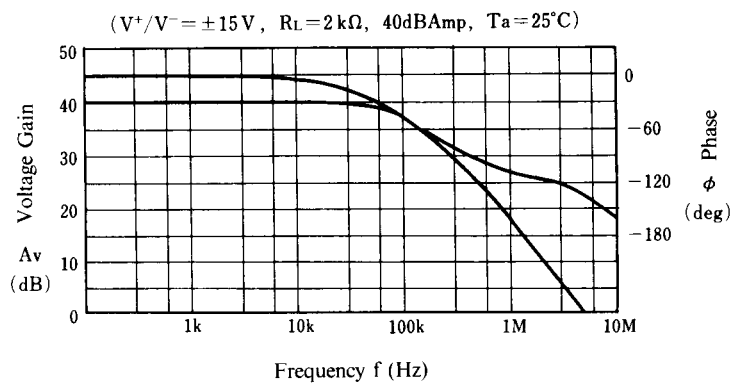

[CAUTION]
 The specifications on this databook are only given for information, without any guarantee as regards either mistakes or omissions. The application circuits in this databook are described only to show representative usages of the product and not intended for the guarantee or permission of any right including the industrial rights.