

20-CHARACTER 2-LINE DOT MATRIX LCD CONTROLLER DRIVER

■ GENERAL DESCRIPTION

The NJU6423B is a 1 Chip Dot Matrix LCD controller driver for up to 20-character 2-line display.

It contains voltage converter, bleeder resistance, CR oscillator, microprocessor interface circuits, instruction decoder controller, character generator ROM/RAM and high voltage operation common and segment drivers.

The voltage converter and bleeder resistance generates about twofold voltage(10V or 6V) and bias voltage for LCD driving waveform internally from single power supply (5V or 3V).Consequently, high-contrast display can be performed though the simple power supply circuits.

The resistance and capacitance for CR oscillation circuits are incorporated, therefore no external components for the oscillation circuits are required.

The microprocessor interface circuits which operate by 2MHz frequency, can be connected directly to 4/8 bit microprocessor.

The character generator consists of 9,600bits ROM and 64 bytes RAM. The standard version ROM is coded with 240 characters including capital and small letter fonts and some of Japanese fonts.

The high voltage operation 32-common and 50-segment drivers operate up to 13.5V or 7V, and drive up to 20-character 2-line LCD panels which divided four common electrode blocks.

■ PACKAGE OUTLINE

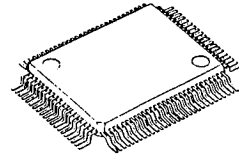

NJU6423BF

■ FEATURES

- 20-character 2-line Dot Matrix LCD Controller Driver
- 4/8 Bit Microprocessor Direct Interface
- Display Data RAM - 80 x 8 bits ; Maximum 20-character 2-line Display
- Character Generator ROM - 9,600 bits ; 240 Characters for 5 x 7 Dots
- Character Generator RAM - 64 x 8 bits ; 8 Patterns(5 x 7 Dots)
- Microprocessor can access to Display Data RAM and Character Generator RAM
- High Voltage LCD Driver ; 32-common / 50-segment
- Programmable Duty Ratio ; 1/16 Duty for 5 x 7 Dots + Cursor, 1 Line
1/32 Duty for 5 x 7 Dots + Cursor, 2 Lines
- Number of Maximum Display Characters

Display Line	Duty	Font	Max. Disp. Characters
1 Line	1/16 duty	5 x 7 dots + cursor	20-character 1-line
2 Lines	1/32 duty	5 x 7 dots + cursor	20-character 2-line

- Useful Instruction Set ; Clear Display, Return Home, Display ON/OFF Cont, Cursor ON/OFF Cont, Display Blink, Cursor Shift, Character Shift
- Power On Initialize Circuit On-chip
- Bleeder Resistance On-chip
- Voltage Converter On-chip
- Oscillation Circuit On-chip
- Low Power Consumption
- Operating Voltage --- 5 V / 3 V
- Package Outline --- Chip / QFP 100 / TCP
- C-MOS Technology

■ TERMINAL DESCRIPTION

NO.	SYMBOL	F U N C T I O N
53	V _{DD}	Power Source (+ 5V / + 3V)
47	V _{SS}	Power Source (0V)
54	RS	Register selection signal input(Pull-up resistance On-chip) "0" : Instruction Register (Writing) Busy Flag, Address Counter (Reading) "1" : Data Register (Writing/Reading)
55	R/W	Read/Write selection signal input(Pull-up Resistance On-chip) "0" : Write , "1" : Read
56	E	Read/Write activation signal input
61~64	DB ₄ ~DB ₇	3-state Data Bus(Upper) to transfer the data between MPU and NJU6423B. DB ₇ is also used for the Busy Flag reading.
57~60	DB ₀ ~DB ₃	3-state Data Bus(Lower) to transfer the data between MPU and NJU6423B. These bus are not used in the 4bit operation.
15~22 23~30 31~38 39~46	COM ₉ ~COM ₁₆ COM ₂₅ ~COM ₃₂ COM ₂₄ ~COM ₁₇ COM ₈ ~COM ₁	LCD Common driving signal No use terminals output no-active signal, or COM ₁₇ ~COM ₃₂ output no-active signal in the 1/16 duty operation.
1~14 65~100	SEG ₃₇ ~SEG ₅₀ SEG ₁ ~SEG ₃₆	LCD Segment driving signal
51 50	C ₁ C ₂	Capacitor for Voltage Doubler Connecting Terminal (+) Capacitor for Voltage Doubler Connecting Terminal (-)
52	V _{ci}	Input Terminal for Voltage Doubler (Normally V _{ci} = V _{DD})
49	V _{OUT}	Voltage Doubler Output Terminal
48	T _{CLK}	Maker Testing Terminal (Normally Open)

5

■ FUNCTIONAL DESCRIPTION

(1) Description for each blocks

(1-1) Register

The NJU6423B incorporates two 8-bit registers, an Instruction Register(IR) and a Data Register(DR). The Register(IR) stores instruction codes such as "Clear Display" and "Return Home", and address data for Display Data RAM(DD RAM) and Character Generator RAM(CG RAM).

The MPU can write the instruction code and address data to the Register(IR), but it cannot read out from the Register(IR).

The Register(DR) is a temporary stored register, the data stored in the Register(DR) is written into the DD RAM or CG RAM and read out from the DD RAM or CG RAM.

The data in the Register(DR) written by the MPU is transferred automatically to the DD RAM or CG RAM by internal operation.

When the address data for the DD RAM or CG RAM is written into the Register(IR), the addressed data in the DD RAM or CG RAM is transferred to the Register(DR). By the MPU read out the data in the Register(DR), the data transmitting process is performed completely.

After reading the data in the Register(DR) by the MPU, the next address data in the DD RAM or CG RAM is transferred automatically to the Register(DR) to provide for the next MPU reading.

These two registers are selected by the selection signal RS as shown below.

Table 1. shows register operation controlled by RS and R/W signals.

Table 1. Register Operation

RS	R/W	Selected Register	Operation
0	0	IR	Write
0	1		Read busy flag(DB ₇) and address counter(DB ₀ ~DB ₆)
1	0	DR	Write (Register(DR) to DD RAM or CG RAM)
1	1		Read (DD RAM or CG RAM to Register(DR))

(1-2) Busy Flag (BF)

When the internal circuits are in the operation mode, the busy flag(BF) is "1", and any instruction reading is inhibited.

The busy flag(BF) is output at DB₇ when RS="0" and R/W="1" as shown in Table 1.

The next instruction should be written after the busy flag(BF) goes to "0".

(1-3) Address Counter (AC)

The address counter(AC) addressing the DD RAM and CG RAM.

When the address setting instruction is written into the Register(IR), the address information is transferred from Register(IR) to the Counter(AC). The selection of either the DD RAM or CG RAM is also determined by this instruction.

After writing (or reading) the display data to (or from) the DD RAM or CG RAM, the Counter(AC) increments (or decrements) automatically.

The address data in the Counter(AC) is output from DB₆~DB₀ when RS="0" and R/W="1" as shown in Table 1.

(1-4) Display Data RAM (DD RAM)

The display data RAM (DD RAM) consists of 80 x 8 bits stores up to 80-character display data represented in 8-bit code.

The unused display data memory area in the DD RAM can be used as a general data memory area. The DD RAM address data set in the address counter (AC) is represented in Hexadecimal.

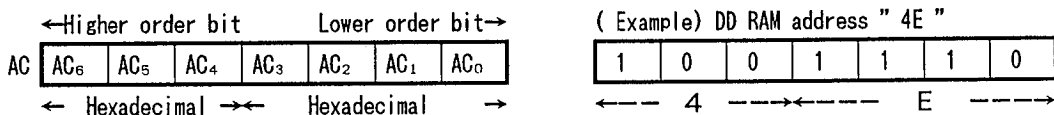

(1-4-1) 20-character 1-line Display (Function set code N=0)

The relation between DD RAM address and display position on the LCD is shown below.

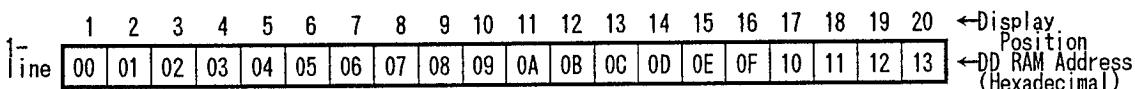

When the display shift is performed, the DD RAM address changes as follows:

(Left Shift Display)

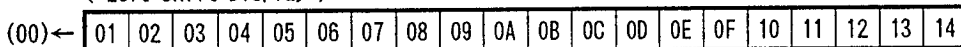

(Right Shift Display)

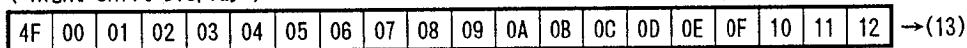

(1-4-2) 20-character 2-line Display (Function set code N=1)

The relation between DD RAM address and display position on the LCD is shown below.

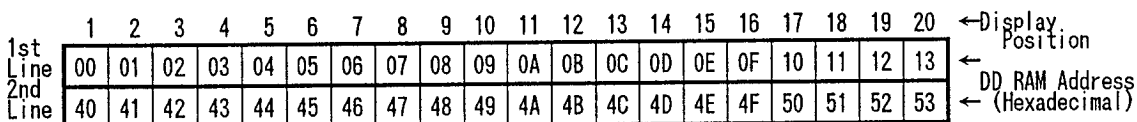

Note : In the 2-line display mode, the 1st and 2nd line address are defined as (00)_H to (27)_H and (40)_H to (67)_H. Please note that the end of 1st line address and the beginning of 2nd line address are not consecutive.

When the display shift is performed, the DD RAM address changes as follows:

(Left Shift Display)

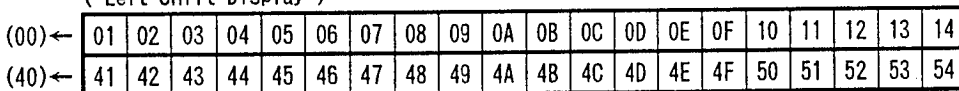

(Right Shift Display)

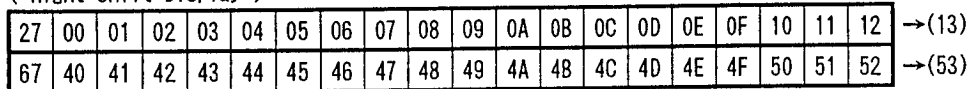

(1-5) Character Generator ROM (CG ROM)

The Character Generator ROM(CG ROM) generates 5 x 7 dots character pattern represented in 8-bit character codes.

The storage capacity is up to 240 kinds of 5 x 7 dots character pattern.

The correspondence between character code and standard character pattern of NJU6423B is shown in Table 2-1 to 2-3.

User-defined character patterns (Custom Font) are also available by mask option.

Table 2-1. CG ROM Character Pattern (ROM version -01)

		Upper 4 bit (Hexadecimal)																
		0	1	2	3	4	5	6	7	8	9	A	B	C	D	E	F	
Lower 4 bit (Hexadecimal)	0 (01)				0	a	P	`	P				—	9	E	e	p	
	1 (02)			!	1	A	Q	a	a				#	7	7	4	a	a
	2 (03)			"	2	B	R	b	r				†	4	W	X	e	e
	3 (04)			#	3	C	S	c	s				∟	7	T	E	e	e
	4 (05)			\$	4	D	T	d	t				√	I	T	†	P	a
	5 (06)			%	5	E	U	e	u				*	*	*	1	0	0
	6 (07)			&	6	F	V	f	v				7	0	∟	∟	p	Z
	7 (08)			'	7	G	W	g	w				7	†	7	7	a	a
	8 (09)			(8	H	X	h	x				4	0	*	U	U	X
	9 (0A))	9	I	Y	i	y				0	7	U	U	'	y
	A (0B)			*	*	J	Z	j	z				∟	∟	∟	∟	j	z
	B (0C)			+	+	K	0	k	0				*	7	E	∟	∟	k
	C (0D)			,	<	L	1	l	1				†	∟	∟	∟	∟	m
	D (0E)			—	=	M	2	m	2				∟	∟	∟	∟	∟	∟
	E (0F)			.	>	N	3	n	3				∟	∟	∟	∟	∟	∟
	F (08)			/	?	O	4	o	4				w	U	7	#	∟	∟

Table 2-2. CG ROM Character Pattern (ROM version -02)

		Upper 4 bits (Hexadecimal)															
		0	1	2	3	4	5	6	7	8	9	A	B	C	D	E	F
Lower 4 bits (Hexadecimal)	0	CG RAM (01)	☐	☐	0	a	P	\	F	Q	é	☐	☐	☐	☐	☐	☐
	1	(02)	☐	!	1	A	0	a	9	0	a	☐	☐	☐	☐	☐	☐
	2	(03)	☐	"	2	B	R	b	r	é	É	"	☐	☐	☐	☐	☐
	3	(04)	☐	#	3	C	S	c	s	à	ò	☐	☐	☐	☐	☐	☐
	4	(05)	☐	\$	4	D	T	d	t	à	ò	\	☐	☐	☐	☐	☐
	5	(06)	☐	%	5	E	U	e	u	à	ò	☐	☐	☐	☐	☐	☐
	6	(07)	☐	&	6	F	V	v	ù	ò	☐	☐	☐	☐	☐	☐	☐
	7	(08)	☐	'	7	G	W	w	ù	ò	☐	☐	☐	☐	☐	☐	☐
	8	(01)	☐	(8	X	H	x	é	é	☐	☐	☐	☐	☐	☐	☐
	9	(02)	☐)	9	I	V	i	ù	ò	☐	☐	☐	☐	☐	☐	☐
	A	(03)	☐	*	#	J	Z	j	z	è	ò	☐	☐	☐	☐	☐	☐
	B	(04)	☐	+	:	K	L	k	l	é	é	☐	☐	☐	☐	☐	☐
	C	(05)	☐	,	<	L	#	l	l	é	é	☐	☐	☐	☐	☐	☐
	D	(06)	☐	-	=	M	I	m	l	é	é	☐	☐	☐	☐	☐	☐
	E	(07)	☐	.	>	N	^	n	→	A	R	a	☐	☐	☐	☐	☐
	F	(08)	☐	/	?	O	_	o	+	A	☐	☐	☐	☐	☐	☐	☐

5

Table 2-3. CG ROM Character Pattern (ROM version -03)

		Upper 4 bits (Hexadecimal)															
		0	1	2	3	4	5	6	7	8	9	A	B	C	D	E	F
Lower 4 bits (Hexadecimal)	0	CG RAM (01)	±		0	0	P	'	F	9	é	á	.	r	A	B	t
	1	(02)	≡	!	1	A	0	a	9	0	a	í	"	J	t	y	U
	2	(03)	7	"	2	R	R	b	r	é	é	é	'	e	8	8	y
	3	(04)	^	#	3	C	S	c	s	á	á	á	'	P	W	e	W
	4	(05)	Y	\$	4	D	T	d	t	á	á	á	'	e	r	Z	o
	5	(06)	Y	%	5	E	U	e	u	á	á	á	'	t	a	n	W
	6	(07)	Y	&	6	F	V	f	v	á	á	á	'	w	↓	0	0
	7	(08)	Y	'	7	B	W	b	w	á	á	á	'	x	+	A	L
	8	(01)	Y	(8	H	X	h	x	á	á	á	'	+	+	E	K
	9	(02)	Y)	9	I	Y	i	y	á	á	á	'	Δ	r	W	Δ
	A	(03)	Y	*	#	J	Z	j	z	á	á	á	'	2	2	2	U
	B	(04)	Y	+	#	K	L	k	l	á	á	á	'	*	L	T	v
	C	(05)	Y	,	<	L	\	l	\	á	á	á	'	*	U	8	0
	D	(06)	Y	-	=	M	I	m	i	á	á	á	'	*	.	W	W
	E	(07)	Y	.	>	N	^	n	^	á	á	á	'	0	0	0	0
	F	(08)	Y	/	?	O	_	o	_	á	á	á	'	0	0	0	0

(1-7) Timing Generator

The timing generator generates a timing signals for the DD RAM, CG RAM, CG ROM and other internal circuits operation.

RAM read timing for the display and internal operation timing for MPU access are separately generated, so that they may not interfere with each other.

Therefore, when the data write to the DD RAM for example, there will be no undesirable influence, such as flickering, in areas other than the display area.

(1-8) LCD Driver

LCD driver consist of 32-common driver and 50-segment driver.

When the line number is selected by a program, the required common drivers output the common driving waveform and the other common drivers output non-selection waveform automatically.

The 50 bits of character pattern data are shifted in the shift-register and latched when the 50 bits shift performed completely. This latched data controls display driver to output LCD driving waveform.

(1-9) Cursor Blinking Control Circuit

This circuits controls cursor On/Off and cursor position character blinks.

The cursor or blinks appear in the digit residing at the DD RAM address set in the address counter (AC).

When the address counter is $(08)_H$, a cursor position is shown as follows:

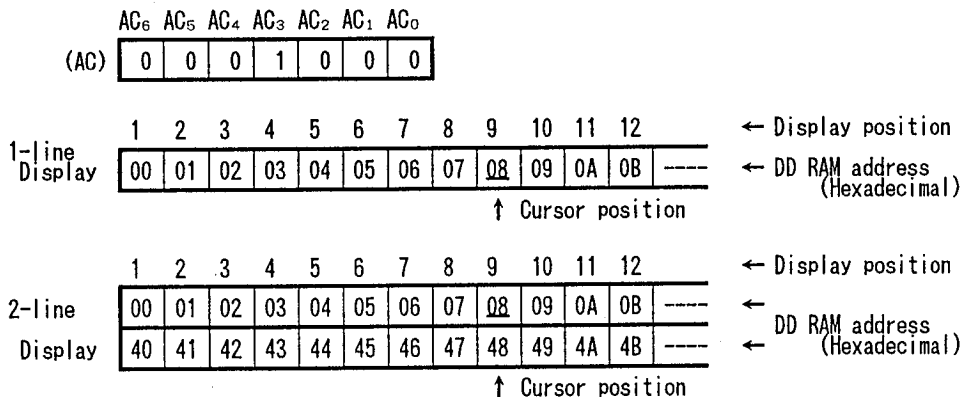

(Note) The cursor or blinks also appear when the address counter (AC) selects the CG RAM.

But the displayed cursor and blink are meaningless.

If the AC storing the CG RAM address data, the cursor and blink are displayed in the meaningless position.

(2) Power on Initialization by internal circuits

The NJU6423B is automatically initialized by internal power on initialization circuits when the power is turned on. In the internal power on initialization, following instructions are executed. During the Internal power on initialization, the busy flag (BF) is "1" and this status is kept 10 ms after V_{DD} rises to 4.5V.

Initialization flow is shown below:

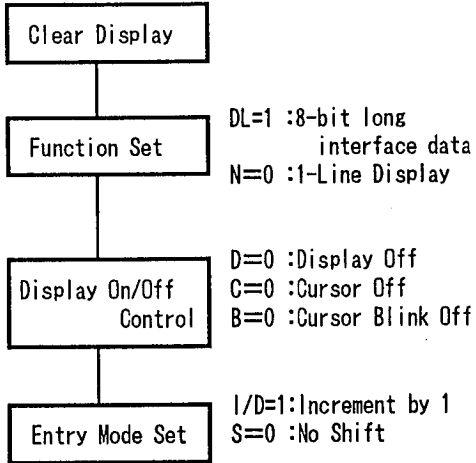

NOTE
If the condition of power supply rise time described in the Electrical Characteristics is not satisfied, the internal Power On Initialization Circuits will not operate and initialization will not be performed. In this case the initialization by MPU software is required.

(3) Instructions

The NJU6423B incorporates two registers, an Instruction Register(IR) and a Data Register(DR).

These two registers store control information temporarily to allow interface between NJU6423B and MPU or peripheral ICs operating different cycles. The operation of NJU6423B is determined by this control signal from MPU. The control information includes register selection signals (RS), read/write signals (R/W) and data bus signals (DB₀ to DB₇).

Table 4. shows each instruction and its operating time.

Note) The execution time mentioned in Table 4. based on fcp or fosc=290kHz.

If the oscillation frequency is changed, the execution time is also changed.

Table 4. Table of Instructions

INSTRUCTIONS	RS	R/W	C DB ₇	O DB ₆	D DB ₅	E DB ₄	DB ₃	DB ₂	DB ₁	DB ₀	DESCRIPTION	EXEC TIME
Maker Testing	0	0	0	0	0	0	0	0	0	0	All "0" code is using for maker testing.	—
Clear Display	0	0	0	0	0	0	0	0	0	1	Display clear and sets DD RAM address 0 in AC.	1.42ms
Return Home	0	0	0	0	0	0	0	0	1	*	Sets DD RAM address 0 in AC and returns display being shifted to original position. DD RAM contents remain unchanged	1.42ms
Entry Mode Set	0	0	0	0	0	0	0	1	I/D	S	Sets cursor move direction and specifies shift of display are performed in data read/write. I/D=1:Increment, I/D=0:Decrement S=1:Accompanies display shift	35us
Display On/Off Control	0	0	0	0	0	0	1	D	C	B	Sets of display On/Off(D), cursor On/Off(C) and blink of cursor position character(B).	35us
Cursor or Display Shift	0	0	0	0	0	1	S/C	R/L	*	*	Moves cursor and shifts display without changing DD RAM contents S/C=1 : Display shift S/C=0 : Cursor shift R/L=1 : Shift to the right R/L=0 : Shift to the left	52us
Function Set	0	0	0	0	1	DL	N	*	*	*	Sets interface data length(DL), number of display lines(N). Sets 5x7 character font. DL=1 : 8 bits, DL=0 : 4 bits N=1 : 2 lines, N=0 : 1 line	35us
Set CG RAM Address	0	0	0	1	←←←←	A _{CG}	→→→→				Sets CG RAM address. After this instruction, the data is transferred to/from CG RAM.	35us
Set DD RAM Address	0	0	1	←←←←	A _{DD}	→→→→					Sets DD RAM address. After this instruction, the data is transferred to/from DD RAM.	35us
Read Busy Flag & Address	0	1	BF	←←←←	AC	→→→→					Reads busy flag and AC contents. BF=1 : Internally operating BF=0 : Can accept instruction	0us
Write Data to CG & DD RAM	1	0	←←←←	Write Data	→→→→						Writes data into DD or CG RAMs.	35us
Read Data from CG or DD RAM	1	1	←←←←	Read Data	→→→→						Reads data from DD or CG RAMs.	52us
Explanation of Abbreviation	DD RAM : Display data RAM, CG RAM : Character generator RAM A _{CG} : CG RAM address, A _{DD} : DD RAM address, Corresponds to cursor address AC : Address counter used for both of DD and CG RAMs											

(3-1) Description of each instructions

(a) Maker Testing

	RS	R/W	DB ₇	DB ₆	DB ₅	DB ₄	DB ₃	DB ₂	DB ₁	DB ₀
Code	0	0	0	0	0	0	0	0	0	0

All "0" code in 4 bit length is using for device testing mode (only for maker).
Therefore, please avoid all "0" input or no meaning Enable signal input at data "0".
(Especially please pay attention the output condition of Enable signal when the power turns on)

(b) Clear Display

	RS	R/W	DB ₇	DB ₆	DB ₅	DB ₄	DB ₃	DB ₂	DB ₁	DB ₀
Code	0	0	0	0	0	0	0	0	0	1

Clear display instruction is executed when the code "1" is written into DB₀.
When this instruction is executed, the space code (20)_H is written into every DD RAM address, the DD RAM address 0 is set into the address counter and entry mode is set increment.
If the cursor or blink are displayed, they are returned to the left end of the LCD (the left end of the 1st line in the 2-line display mode).

The S of entry mode does not change.

Note: The character pattern for character code (20)_H must be blank code in the user-defined character pattern(Custom font).

(c) Return Home

	RS	R/W	DB ₇	DB ₆	DB ₅	DB ₄	DB ₃	DB ₂	DB ₁	DB ₀	
Code	0	0	0	0	0	0	0	0	1	*	* = Don't care

Return home instruction is executed when the code "1" is written into DB₁. When this instruction is executed, the DD RAM address 0 is set into the address counter. Display is returned its original position if shifted, the cursor or blink are returned to the left end of the LCD (the left end of the 1st line in the 2-line display mode) if the cursor or blink are on the display.

The DD RAM contents do not change.

(d) Entry Mode Set

	RS	R/W	DB ₇	DB ₆	DB ₅	DB ₄	DB ₃	DB ₂	DB ₁	DB ₀
Code	0	0	0	0	0	0	0	1	I/D	S

Entry mode set instruction which sets the cursor moving direction and display shift On/Off, is executed when the code "1" is written into DB₂ and the codes of (I/D) and (S) are written into DB₁(I/D) and DB₀(S), as shown below.

(I/D) sets the address increment or decrement, and the (S) sets the entire display shift in the DD RAM writing.

I/D	F u n c t i o n
1	Address increment: The address of the DD RAM or CG RAM increment (+1) when the read/write, and the cursor or blink move to the right.
0	Address decrement: The address of the DD RAM or CG RAM decrement (-1) when the read/write, and the cursor or blink move to the left.

S	F u n c t i o n
1	Entire display shift. The shift direction is determined by I/D: shift to the left at I/D=1 and shift to the right at the I/D=0. The shift is operated only for the character, so that it looks as if the cursor stands still and the display moves. The display does not shift when reading from the DD RAM and writing/reading into/from CG RAM.
0	The display does not shifting.

5

(e) Display On/Off Control

	RS	R/W	DB ₇	DB ₆	DB ₅	DB ₄	DB ₃	DB ₂	DB ₁	DB ₀
Code	0	0	0	0	0	0	1	D	C	B

Display On/Off control instruction which controls the whole display On/Off, the cursor On/Off and the cursor position character blink, is executed when the code "1" is written into DB₃ and the codes of (D), (C) and (B) are written into DB₂(D), DB₁(C) and DB₀(B), as shown below.

D	F u n c t i o n
1	Display On.
0	Display Off. In this mode, the display data remains in the DD RAM so that it is retrieved immediately on the display when the D change to 1.

C	F u n c t i o n
1	Cursor On. The cursor is displayed by 5 dots on the 8th line.
0	Cursor Off. Even if the display data write, the I/D etc does not change.

B	F u n c t i o n
1	The cursor position character is blinking. Blinking rate is 508.7ms at $f_{osc} = 290\text{kHz}$. The blink is displayed alternatively with all on (it means all black) and characters display. The cursor and the blink can be displayed simultaneously.
0	The character does not blink.

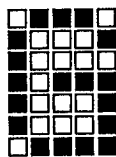

Character Font 5 x 7 dots

(1) Cursor display example

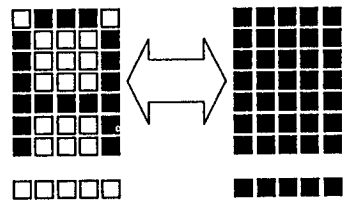

Alternating display

(2) Blink display example

(f) Cursor/Display Shift

	RS	R/W	DB ₇	DB ₆	DB ₅	DB ₄	DB ₃	DB ₂	DB ₁	DB ₀	
Code	0	0	0	0	0	1	S/C	R/L	*	*	* = Don't care

The Cursor/Display shift instruction shifts the cursor position or display to the right or left without writing or reading display data. This function is used to correct or search the display. In the 2-line display, the cursor moves to the 2nd line when it passes the 40th digit of the 1st line. Notice that the 1st and 2nd line displays will shift at the same time. When the displayed data is shifted repeatedly, each line moves only horizontally.

The 2nd line display does not shift into the 1st line position.

The contents of address counter(AC) does not change by operation of the display shift only.

This instruction is executed when the code "1" is written into DB₄ and the codes of (S/C) and (R/L) are written into DB₃(S/C) and DB₂(R/L), as shown below.

S/C	R/L	F u n c t i o n
0	0	Shifts the cursor position to the left ((AC) is decremented by 1)
0	1	Shifts the cursor position to the right ((AC) is incremented by 1)
1	0	Shifts the entire display to the left and the cursor follows it.
1	1	Shifts the entire display to the right and the cursor follows it.

(g) Function Set

	RS	R/W	DB ₇	DB ₆	DB ₅	DB ₄	DB ₃	DB ₂	DB ₁	DB ₀	
Code	0	0	0	0	1	DL	N	*	*	*	* = Don't care

Function set instruction which sets the interface data length and number of display lines, is executed when the code "1" is written into DB₅ and the codes of (DL) and (N) are written into DB₄(DL) and DB₃(N), as shown below (character font is fixed 5 x 7 dots).

(DL) sets the interface data length and (N) sets the number of display lines either the 1-line or 2-line.

NOTE

This function set instruction must be performed at the head of the program prior to all other existing instructions(except Busy flag/Address read). This function set instruction can not be executed afterwards unless the interface data length change.

DL	F u n c t i o n
1	Set the interface data length to 8-bit (DB ₇ to DB ₀)
0	Set the interface data length to 4-bit (DB ₇ to DB ₄) The data must be sent or received twice in this mode.

N	Display lines	Character Font	Duty ratio	N o t e
0	1	5 x 7 dots	1/16	
1	2	5 x 7 dots	1/32	

(h) Set CG RAM Address

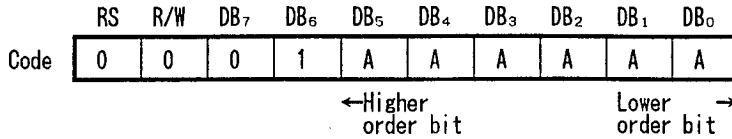

Set CG RAM address set instruction is executed when the code "1" is written into DB₆ and the address is written into DB₅ to DB₀ as shown above.

The address data mentioned by binary code "AAAAAA" is written into the address counter (AC) together with the CG RAM addressing condition. After this instruction execution, the data writing/reading is performed into/from the CG RAM.

(i) Set DD RAM Address

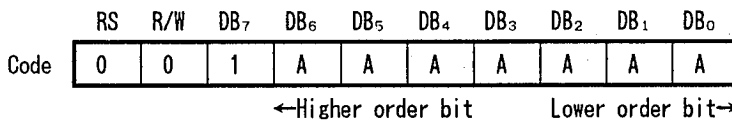

Set DD RAM address instruction is executed when the code "1" is written into DB₇ and the address is written into DB₆ to DB₀ as shown above.

The address data mentioned by binary code "AAAAAAA" is written into the address counter (AC) together with the DD RAM addressing condition. After this instruction execution, the data writing/reading is performed into/from the DD RAM.

Note : In case of the 1-line display, the address data is (00)_H to (4F)_H, and during the 2-line display, the address is (00)_H to (27)_H for the 1st line and (40)_H to (67)_H for the 2nd line.

(j) Read Busy Flag & Address

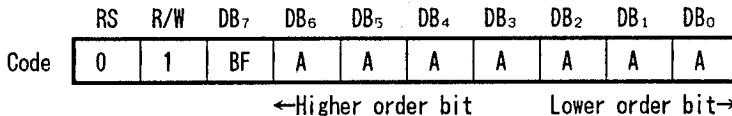

This instruction reads out the internal status of the NJU6423B. When this instruction is executed, the busy flag (BF) which indicate internal operation is read out from DB₇ and the address of the CG RAM or DD RAM is read out from DB₆ to DB₀ (the address for the CG RAM or DD RAM is determined by the previous instruction).

(BF)="1" indicates that internal operation is in progress. The next instruction is inhibited when (BF)="1". Check the (BF) status before the next write operation.

(k) Write Data to CG RAM or DD RAM

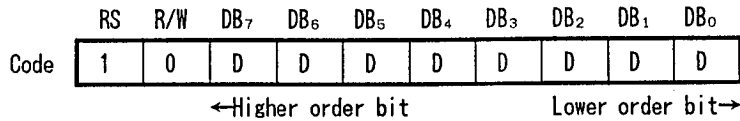

Write Data to CG RAM or DD RAM instruction is executed when the code "1" is written into (RS) and code "0" is written into (R/W).

By the execution of this instruction, the binary 8 bit data "DDDDDDDD" are written into the CG RAM or DD RAM. The selection of the CG RAM or DD RAM is determined by the previous instruction. After this instruction execution, the address increment (+1) or decrement (-1) is performed automatically according to the entry mode set. And the display shift is also executed according to the previous entry mode set.

(l) Read Data from CG RAM or DD RAM

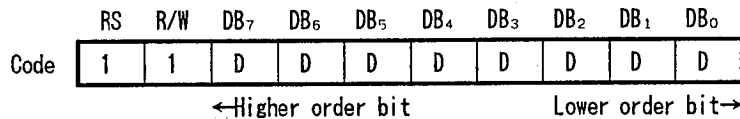

Read Data from CG RAM or DD RAM instruction is executed when the code "1" is written into (RS) and (R/W).

By the execution of this instruction, the binary 8 bit data "DDDDDDDD" are read out from the CG RAM or DD RAM. The selection of the CG RAM or DD RAM is determined by the previous instruction.

Before executing this instruction, either the CG RAM address set or DD RAM address set must be executed, otherwise the first read out data are invalidated.

When this instruction is serially executed, the next address data is normally read from the second read.

The address set instruction is not required if the cursor shift instruction is executed just beforehand (only DD RAM reading).

The cursor shift instruction has same function as the DD RAM address set, so that after reading the DD RAM, the address increment or decrement is executed automatically according to the entry mode.

But display shift does not occur regardless of the entry mode.

Note: The address counter (AC) is automatically incremented or decremented by 1 after write instructions to either of the CG RAM or DD RAM. Even if the read instruction is executed after this instruction, the addressed data can not be read out correctly. For a correct data read out, either the address set instruction or cursor shift instruction (only with DD RAM) must be implemented just before this instruction or from the second time read out instruction execution if the read out instruction is executed 2 times consecutively.

5

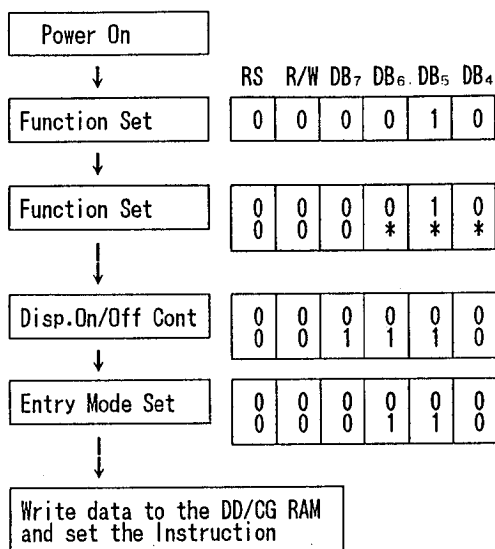

Initialized.
No display appears.

Set the 4-bit operation.
This step is executed in 8-bit mode
set by the initialization.

Set the 4-bit operation,
1-line display, 5 X 7dots Font.
The 4-bit operation starts from this
step.

Turn on display and cursor.
Entire display is in space mode set by
the initialization.

Example for set address increment and
cursor right shift when the data write
to the DD RAM or CG RAM.

(c) 20-character 2-line in 8-bit operation (Using internal reset circuits).

In the 2-line display, the cursor moves automatically from the 1st to the 2nd line after the 40th character of the first line has been written. Therefore, if the display character is only 20 characters in the 1st line, the DD RAM address must be set by the user programming to change the cursor position to the 2nd line.

The 1st and 2nd line displays will shift at the same time.

When the displayed data is shifted repeatedly, each line moves only horizontally. The 2nd line display does not shift into the 1st line position.

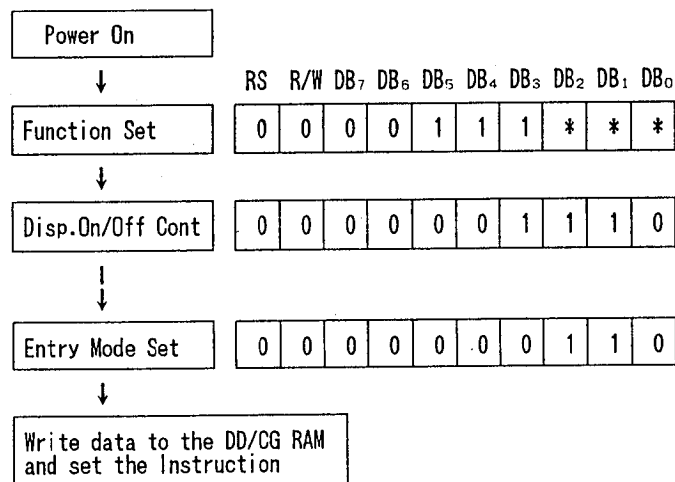

Initialized.
No display appears.

Set the 8-bit operation,
2-line display, 5 X 7dots
Font.

Turns on display and cur-
sor. Entire display is in
space mode set by the
initialization.

Example for set address
increment and cursor
right shift when the data
write to the DD or CG RAM.

(3-3) Initialization by instruction

If the power supply conditions for the correct operation of the internal reset circuits are not met, the NJU6423B must be initialized by the instruction.

(a) Initialization by Instruction in 8-bit interface length.

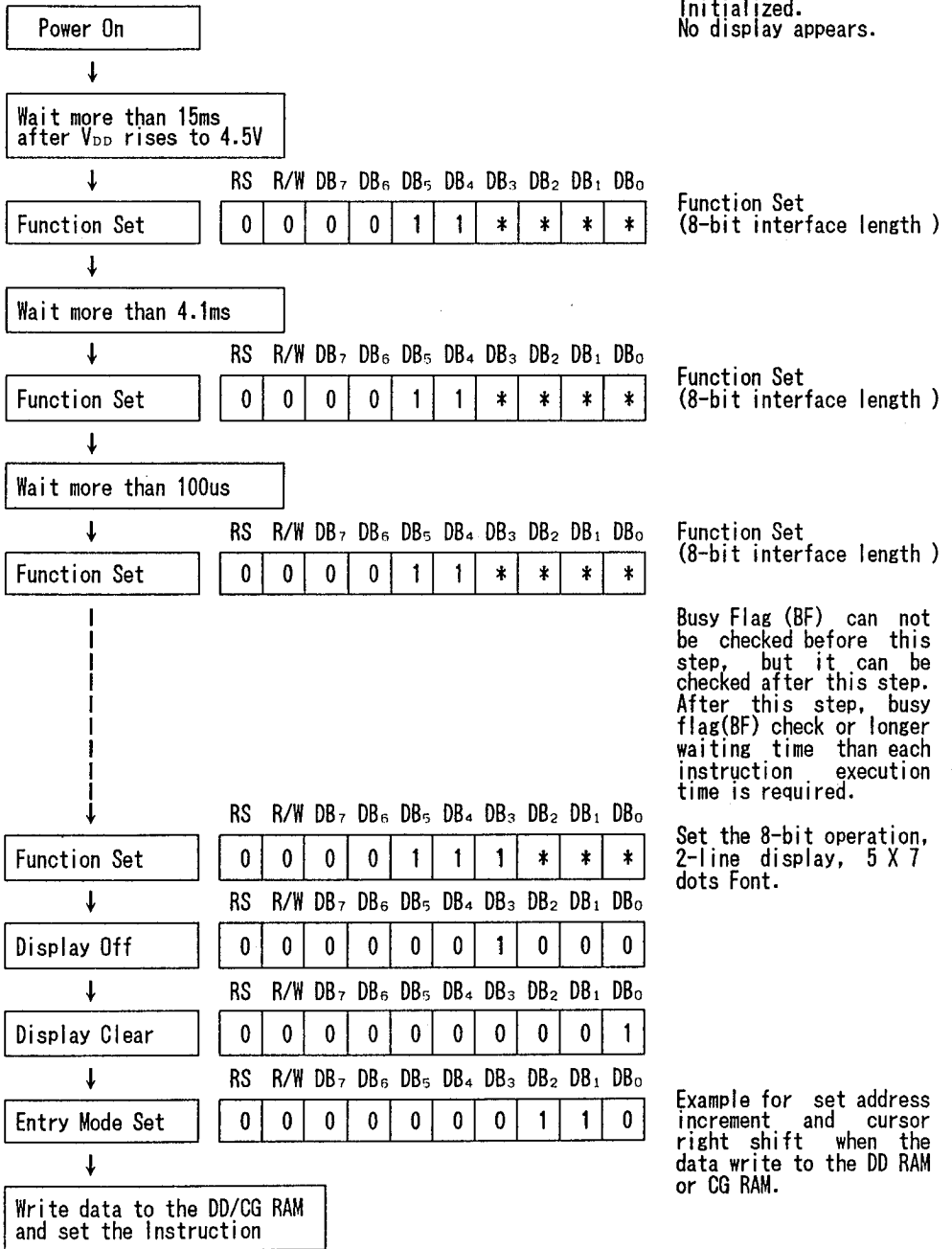

Initialized.
No display appears.

Function Set
(8-bit interface length)

Function Set
(8-bit interface length)

Function Set
(8-bit interface length)

Busy Flag (BF) can not be checked before this step, but it can be checked after this step. After this step, busy flag(BF) check or longer waiting time than each instruction execution time is required.

Set the 8-bit operation, 2-line display, 5 X 7 dots Font.

Example for set address increment and cursor right shift when the data write to the DD RAM or CG RAM.

(b) Initialization by Instruction in 4-bit interface length

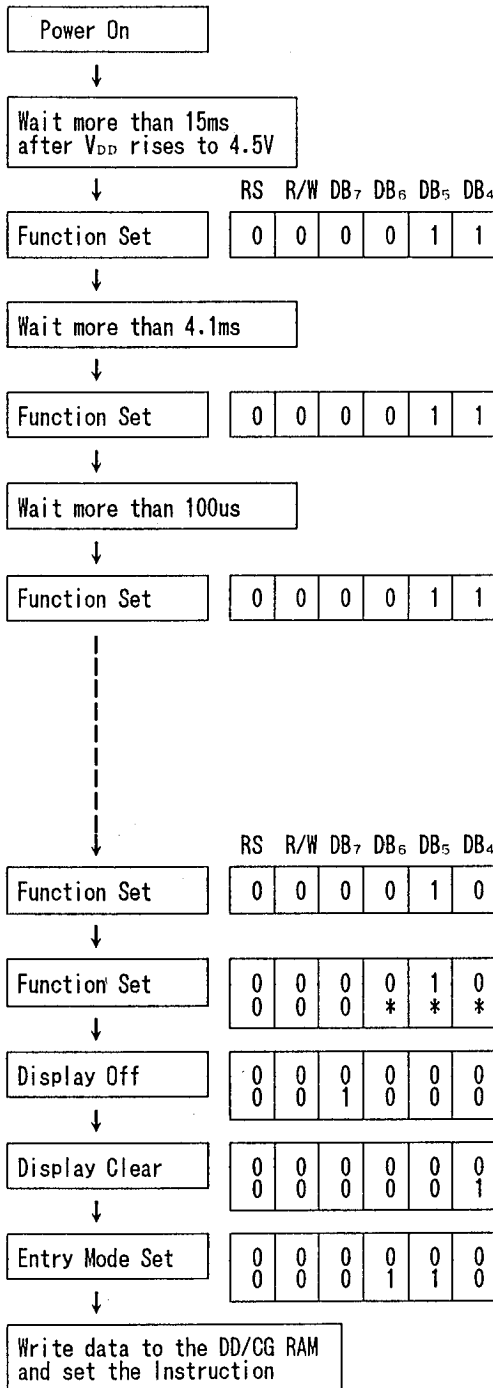

Initialized.
No display appears.

Function Set
(8-bit interface length)

Function Set
(8-bit interface length)

Function Set
(8-bit interface length)

Busy Flag (BF) can not be checked before this step, but it can be checked after this step. After this step, busy flag (BF) check or longer waiting time than each instruction execution time is required.

Function Set
Set 4-bit interface length by 8-bit interface length.

Set the 4-bit operation, 1-line display, 5 X 7dots Font.

Example for set address increment and cursor right shift when the data write to the DD RAM or CG RAM.

5

(4) LCD DISPLAY

(4-1) Power Supply for LCD Driving

NJU6423B incorporate voltage doubler to generate LCD driving high voltage and bleeder resistance. The voltage doubler generate about twofold voltage from the V_{ci} input voltage. (9.5V typ at $I_{out}=2mA$ and $V_{ci}=5V$) and bleeder resistance generate each LCD driving voltage.

The bleeder resistance is set 1/6.7 bias suitable for 1/32 duty ratio and each resistance value are $1k\Omega$ typ for R_1, R_2, R_4 and R_5 , and $2.7k\Omega$ typ for R_3 .

LCD Driving Voltage vs Duty Ratio

Power supply	Duty Ratio	1/32
		Bias
V_{LCD}		V_{DD} to V_{OUT}

Internal Bleeder Resistance

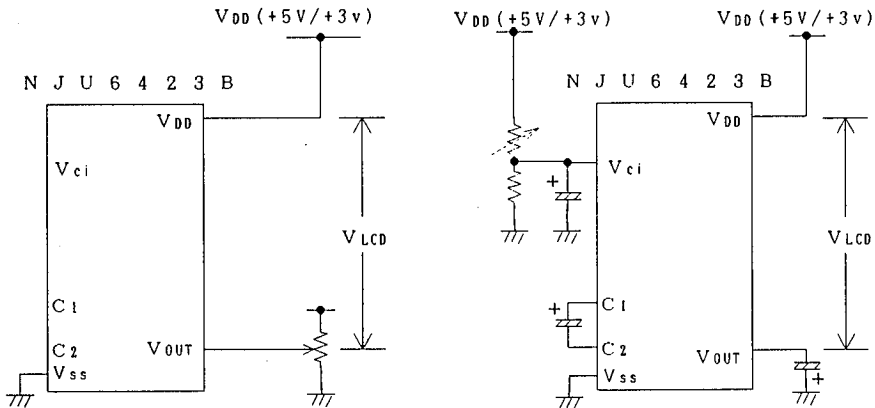
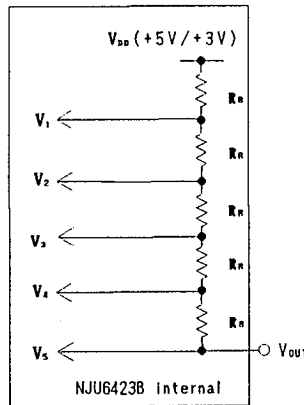

(a) 1/6.7 Bias (1/32 Duty)
 (Internal Voltage Doubler No-use Example)

(b) 1/6.7 Bias (1/32 Duty)
 (Internal Voltage Doubler Using Example)

(4-2) Relation between oscillation frequency and LCD frame frequency.

As the NJU6423B incorporate oscillation capacitor and resistance for CR oscillation, 290kHz oscillation is available without any external components.

The LCD frame frequency example mentioned below is based on 290kHz oscillation.
 (1 clock = 3.4us)

(a) 1/32 duty

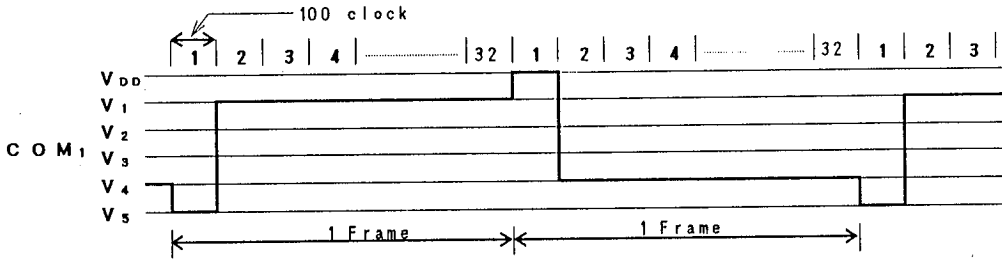

$$1 \text{ frame} = 3.4(\text{us}) \times 100 \times 32 = 10,880(\text{us}) = 10.9(\text{ms})$$

$$\text{Frame frequency} = 1/10.9(\text{ms}) = 91.7(\text{Hz})$$

(5) Interface with MPU

NJU6423B can be interfaced with both of 4/8 bit MPU and the two-time 4-bit or one-time 8-bit data transfer is available.

(5-1) 4-bit MPU interface

When the interface length is 4-bit, the data transfer is performed by 4 lines connected to DB₄ to DB₇ (DB₀ to DB₃ are not used). The data transfer with the MPU is completed by the two-time 4-bit data transfer.

The data transfer is executed in the sequence of upper 4-bit (the data DB₄ to DB₇ at 8-bit length) and lower 4-bit (the data DB₀ to DB₃ at 8-bit length).

The busy flag check must be executed after two-time 4-bit data transfer (1 instruction execution). In this case the data of busy flag and address counter are also output twice.

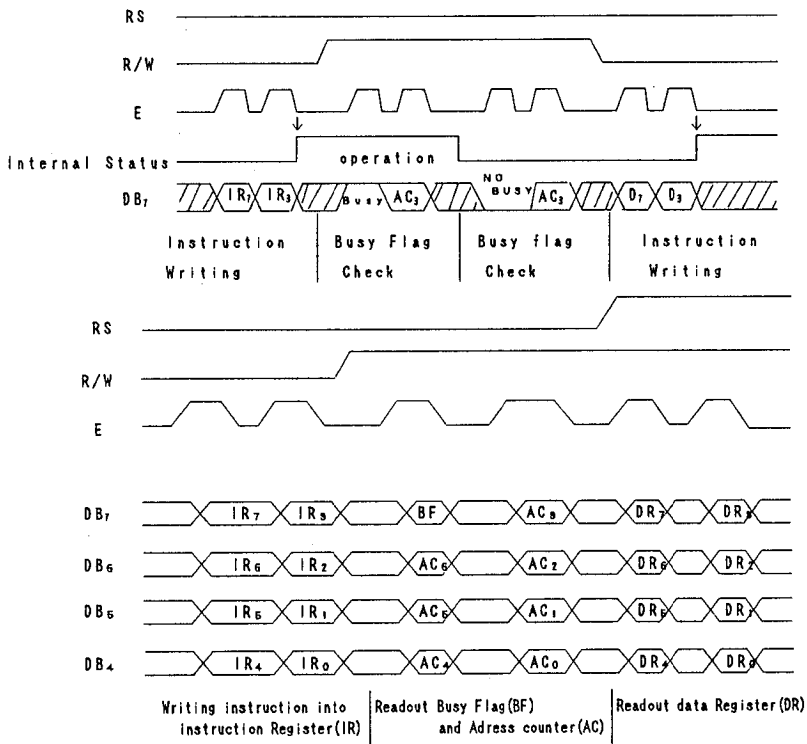

(5-2) 8-bit MPU interface

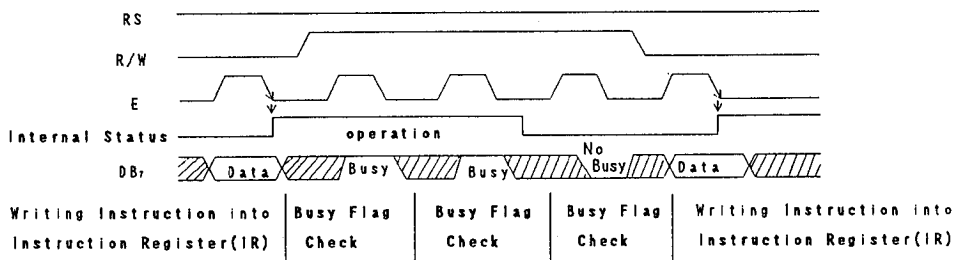

■ ABSOLUTE MAXIMUM RATINGS

(Ta=25°C)

PARAMETER	SYMBOL	RATINGS	UNIT
Supply Voltage (1)	V _{DD}	- 0.3 ~ + 7.0	V
Input Voltage	V _r	- 0.3 ~ V _{DD} +0.3	V
Operating Temperature	T _{opr}	- 30 ~ + 80	°C
Storage Temperature	T _{stg}	- 55 ~ + 125	°C

Note 1) If the LSI are used on condition above the absolute maximum ratings, the LSI may be destroyed.

Using the LSI within electrical characteristics is strongly recommended for normal operation.

Use beyond the electric characteristics conditions will cause malfunction and poor reliability.

Note 2) All voltage values are specified as V_{SS} = 0 V

Note 3) The relation : V_{DD} ≥ V_{ci} > V_{OUT} , V_{DD} > V_{SS} ≥ V_{OUT} , V_{SS}=0V must be maintained.

Note 4) Decoupling capacitor (C_D) should be connected between V_{ci} and V_{SS} due to the stabilized operation for the voltage doubler.

■ ELECTRICAL CHARACTERISTICS

 (V_{DD}=5V±10% , Ta=-20 ~ +75°C)

PARAMETER		SYMBOL	CONDITIONS	MIN	TYP	MAX	UNIT	NOTE	
Operating Voltage		V _{DD}		4.5	5.0	5.5	V		
Input Voltage		V _{IH1}	All Input and Input/Output terminals except OSC	2.3		V _{DD}	V	5	
		V _{IL1}			0.8				
Output Voltage		V _{OH1}	Input/Output terminals	-I _{OH} =0.205mA	2.4		V	6	
		V _{OL1}							I _{OL} =1.6mA
Driver On-resist.(COM)		R _{COM}	±I _d =0.05mA(All com.term.)			20	kΩ	7	
Driver On-resist.(SEG)		R _{SEG}	±I _d =0.05mA(All seg.term.)			30			
Input Leakage Current		I _{L1}	V _{IN} =0 ~ V _{DD}	- 1		1	uA	8	
Pull-up Resist Current		-I _P	V _{DD} =5V, RS, R/W, DB	50	125	250			
Operating Current		I _{DD1}	V _{DD} =5V	NJU6423B		1.9	3.3	mA	9
		I _{DD2}			NJU6423BL				
		I _{DD3}	内蔵CR発振	NJU6423BS		0.8	1.5		
Voltage Doubler	Output Volt.	V _{up}	V _{ci} =5V, Ta=25°C, V _{out}	-4.0	-4.6		V	10	
	Conv.Effici.	V _{EF}	R _L =∞	95	99.9		%		
	Input Volt.	V _{ci}		2.5		5.5	V		
Built-in Bleeder resistance (For LCD Driving Voltage)		B	R ₁ , R ₂	Ta=25°C		1.00		kΩ	
			R ₄ , R ₅			2.70			
		BL	R ₁ , R ₂	Ta=25°C		2.00			
			R ₄ , R ₅			5.40			
		BS	R ₁ , R ₂	Ta=25°C		4.00			
			R ₄ , R ₅			10.80			
Oscillation Frequency		f _{osc}	V _{DD} =5V, Ta=25°C	190	290	350	kHz	11	
LCD Driving Voltage		V _{LCD}	V _{DD} - V _S 1/6.7 Bias	0		V _{DD} -13.5	V	12	

5

ELECTRICAL CHARACTERISTICS

 ($V_{DD}=3V \pm 20\%$, $T_a=-20 \sim +75^\circ C$)

PARAMETER		SYMBOL	CONDITIONS	MIN	TYP	MAX	UNIT	NOTE
Operating Voltage		V_{DD}		2.4	3.0	3.6	V	
Input Voltage		V_{IH1}	All Input and Input/Output terminals except OSC	$0.8V_{DD}$		V_{DD}	V	5
		V_{IL1}						
Output Voltage		V_{OH1}	Input/Output terminals	$-I_{OH}=0.205mA$	2.0		V	6
		V_{OL1}						
Driver On-resist. (COM)		R_{COM}	$\pm I_d=0.05mA$ (All com. term.)			20	$k\Omega$	7
Driver On-resist. (SEG)		R_{SEG}	$\pm I_d=0.05mA$ (All seg. term.)			30		
Input Leakage Current		I_{L1}	$V_{IN}=0 \sim V_{DD}$	-1		1	μA	8
Pull-up Resist Current		$-I_P$	$V_{DD}=3V$, RS, R/W, DB	10	25	50		
Operating Current		I_{DD1}	$V_{DD}=5V$	NJU6423B		0.75	mA	9
		I_{DD2}				NJU6423BL		
		I_{DD3}	内蔵CR発振	NJU6423BS	*	*		
Voltage Doubler	Output Volt.	V_{up}	$V_{ci}=3V$, $T_a=25^\circ C$, V_{out}	-2.4	-2.8		V	10
	Conv. Effici	V_{EF}	$R_L=\infty$	95	99.9		%	
	Input Volt.	V_{ci}		1.8		V_{DD}	V	
Built-in Bleeder resistance (For LCD Driving Voltage)	B	R_1, R_2, R_4, R_5	$T_a=25^\circ C$		1.00		$k\Omega$	
		R_3						
	BL	R_1, R_2, R_4, R_5	$T_a=25^\circ C$		2.00			
		R_3						
	BS	R_1, R_2, R_4, R_5	$T_a=25^\circ C$		4.00			
		R_3						
Oscillation Frequency		fosc	$V_{DD}=3V$, $T_a=25^\circ C$	160	260	320	kHz	11
LCD Driving Voltage		V_{LCD}	$V_{DD} - V_s$ 1/6.7 Bias	0		$V_{DD} - 7.0$	V	12

Note 5) Input/Output structure except LCD driver are shown below :

Input Terminal Structure

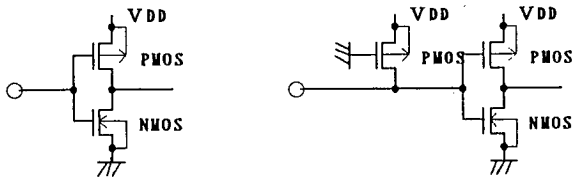

E Terminal

RS, R/W Terminal

Input/Output Terminal Structure

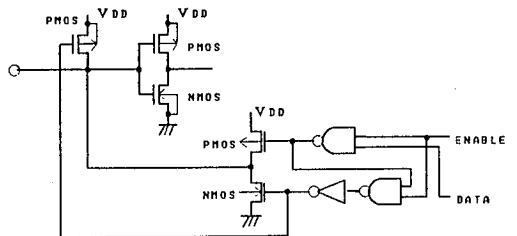

 DB₀ to DB₇ Terminal

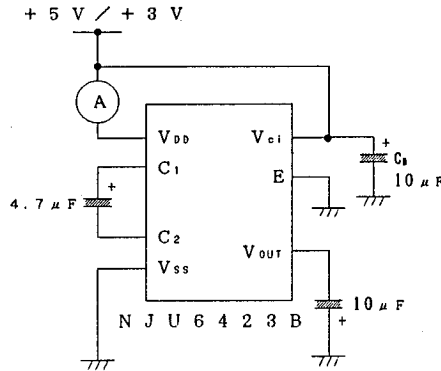
- Note 6) Apply to the Output and Input/Output Terminal.
- Note 7) R_{COM} and R_{SEG} are the resistance values between power supply terminals (V_{DD} , V_1 , V_4 , V_5) and each common terminal (COM_1 to COM_{32}), and supply voltage (V_{DD} , V_2 , V_3 , V_5) and each segment terminal (SEG_1 to SEG_{50}) respectively, and measured when the current I_d is flown on every common and segment terminals at a same time.
- Note 8) Except pull-up resistance current and output driver current.
- Note 9) Except Input/output current but including the current flow on bleeder resistance. If the input level is medium, current consumption will increase due to the penetration current. Therefore, the input level must be fixed to "H" or "L".

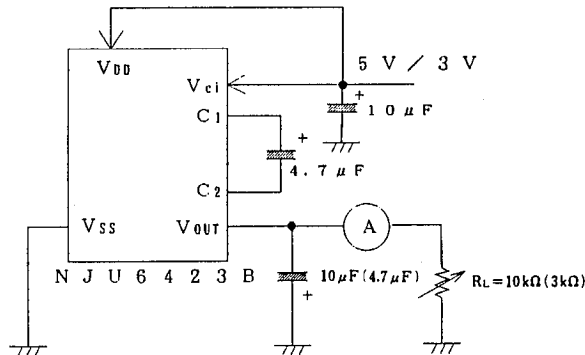

Note 10) Voltage Doubler Characteristics Measuring Circuit.

5



Note 11) Supply Voltage vs Oscillating Frequency

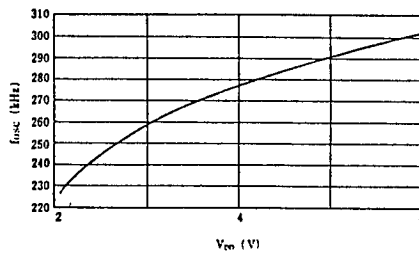

- Note 12) Apply to the output voltage from each COM and SEG are less than $\pm 0.15V$ against the LCD driving constant voltage (V_{DD} , V_{OUT}) at no load condition.

• Bus timing characteristics

Write operation (Write from MPU to NJU6423B)

 ($V_{DD} = 5.0V \pm 10\%$, $V_{SS} = 0V$, $T_a = -20 \sim +75^\circ C$)

PARAMETER	SYMBOL	MIN	MAX	CONDITION	UNIT
Enable Cycle Time	t_{CYCE}	500		fig.1	ns
Enable Pulse Width "High" level	PW_{EH}	220			
Enable Rise Time, Fall Time	t_{Er} , t_{Ef}		20		
Set up Time RS, R/W, E	t_{AS}	40			
Address Hold Time	t_{AH}	10			
Data Set up Time	t_{DSW}	60			
Data Hold Time	t_H	10			

Write operation (Write from MPU to NJU6423B)

 ($V_{DD} = 3.0V \pm 20\%$, $V_{SS} = 0V$, $T_a = -20 \sim +75^\circ C$)

PARAMETER	SYMBOL	MIN	MAX	CONDITION	UNIT
Enable Cycle Time	t_{CYCE}	1.4		fig.1	μs
Enable Pulse Width "High" level	PW_{EH}	500			ns
Enable Rise Time, Fall Time	t_{Er} , t_{Ef}		20		
Set up Time RS, R/W, E	t_{AS}	70			
Address Hold Time	t_{AH}	10			
Data Set up Time	t_{DSW}	140			
Data Hold Time	t_H	10			

Timing Characteristics (Write operation)

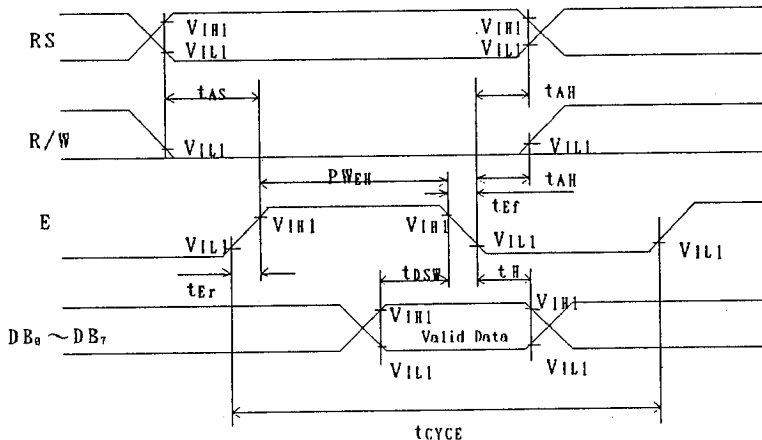
 fig. 1 The timing characteristics of the bus write operating sequence.
 (Write from MPU to NJU6423B)

Read operation (Read from NJU6423B to MPU)
 ($V_{DD} = 5.0V \pm 10\%$, $V_{SS} = 0V$, $T_a = -20 \sim +75^\circ C$)

PARAMETER		SYMBOL	MIN	MAX	CONDITION	UNIT
Enable Cycle Time		t_{CYCE}	500		fig.2	ns
Enable Pulse Width	"High" level	PW_{EH}	220			
Enable Rise Time, Fall Time		t_{Er} , t_{Ef}		20		
Set up Time	RS, R/W, E	t_{AS}	40			
Address Hold Time		t_{AH}	10			
Data Delay Time		t_{DDW}		120		
Data Hold Time		t_{DDH}	20			

Read operation (Read from NJU6423B to MPU)
 ($V_{DD} = 3.0V \pm 20\%$, $V_{SS} = 0V$, $T_a = -20 \sim +75^\circ C$)

PARAMETER		SYMBOL	MIN	MAX	CONDITION	UNIT
Enable Cycle Time		t_{CYCE}	1.4		fig.2	μs
Enable Pulse Width	"High" level	PW_{EH}	500			ns
Enable Rise Time, Fall Time		t_{Er} , t_{Ef}		20		
Set up Time	RS, R/W, E	t_{AS}	40			
Address Hold Time		t_{AH}	70			
Data Delay Time		t_{DDW}		600		
Data Hold Time		t_{DDH}	20			

Load Condition of DB_0 to DB_7 : $C_L = 100pF$

Timing Characteristics (Read operation)

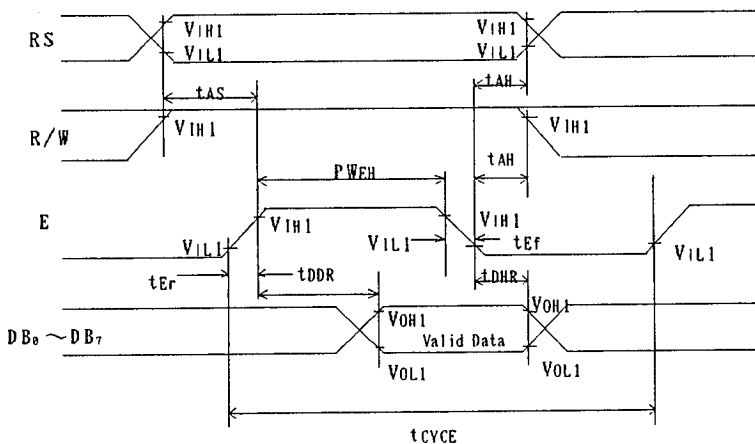

fig. 2 The timing characteristics of the bus read operating sequence.
 (read from NJU6423B to MPU)

5

- Power Supply Condition when using the internal initialization circuit
($V_{DD} = 5.0V \pm 10\%$, $V_{SS} = 0V$, $T_a = -20 \sim +75^\circ C$)

PARAMETER	SYMBOL	MIN	TYP	MAX	CONDITION	UNIT
Power Supply Rise Time	t_{rcc}	0.1	—	10		ms
Power Supply OFF Time	t_{off}	1	—			

- Power Supply Condition when using the internal initialization circuit
($V_{DD} = 3.0V \pm 20\%$, $V_{SS} = 0V$, $T_a = -20 \sim +75^\circ C$)

PARAMETER	SYMBOL	MIN	TYP	MAX	CONDITION	UNIT
Power Supply Rise Time	t_{rcc}	0.1	—	5		ms
Power Supply OFF Time	t_{off}	1	—			

Since the internal initialization circuits will not operate normally unless the above conditions are met, in such a case initialize by instruction.
(Refer to initialization by the instruction)

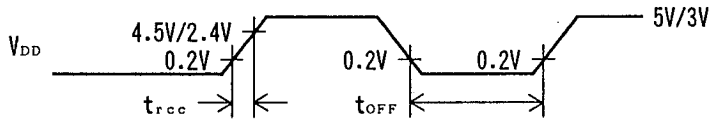

$$\begin{aligned}
 V_{DD}=5V & \text{ ---- } 0.1ms \leq t_{rcc} \leq 10ms & t_{off} \geq 1ms \\
 V_{DD}=3V & \text{ ---- } 0.1ms \leq t_{rcc} \leq 5ms
 \end{aligned}$$

t_{off} specifies power off time in a short period off or cyclical on/off.

LCD DRIVING WAVEFORM

1/16 Duty Driving

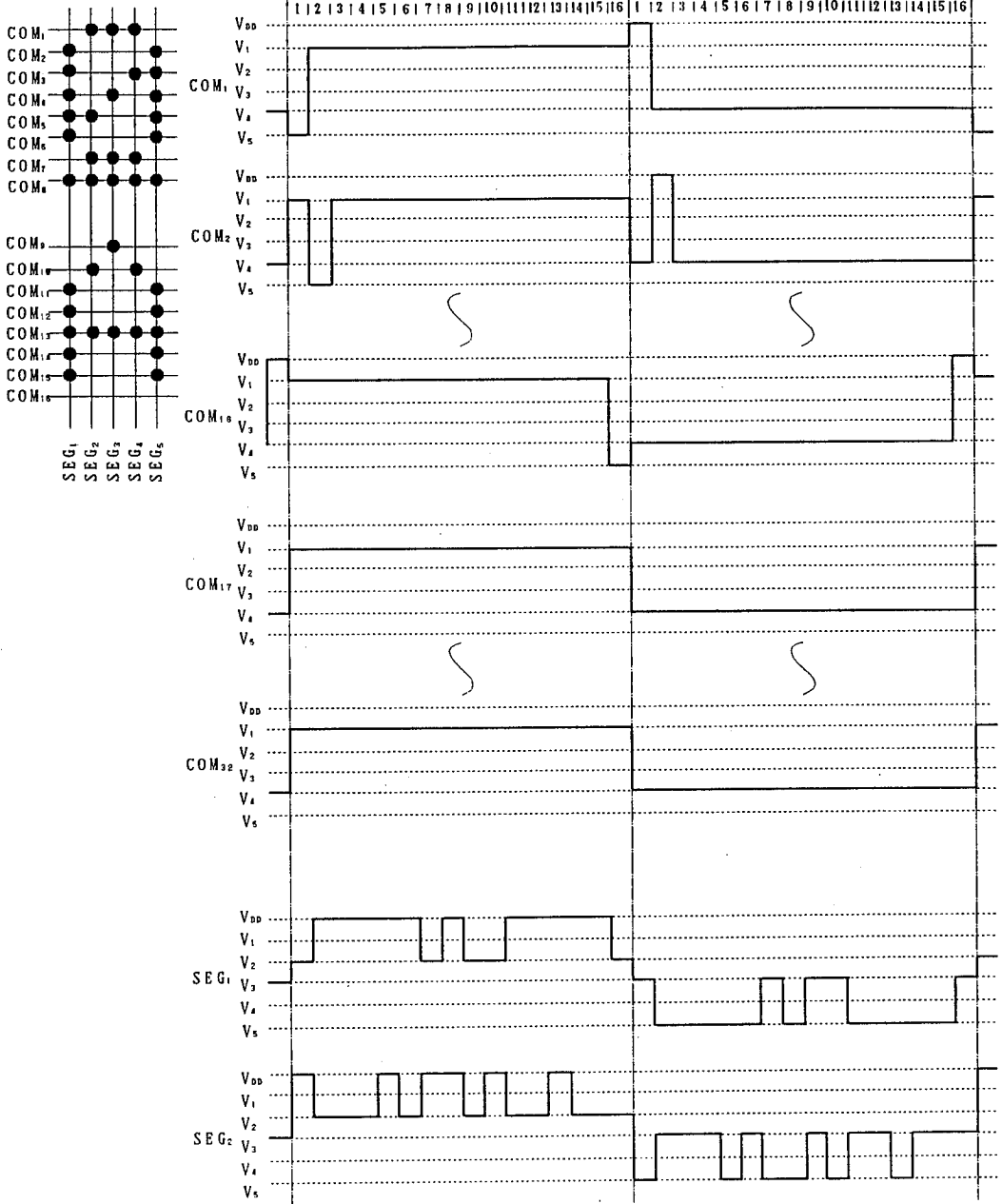

■ LCD DRIVING WAVEFORM

1/32 Duty Driving

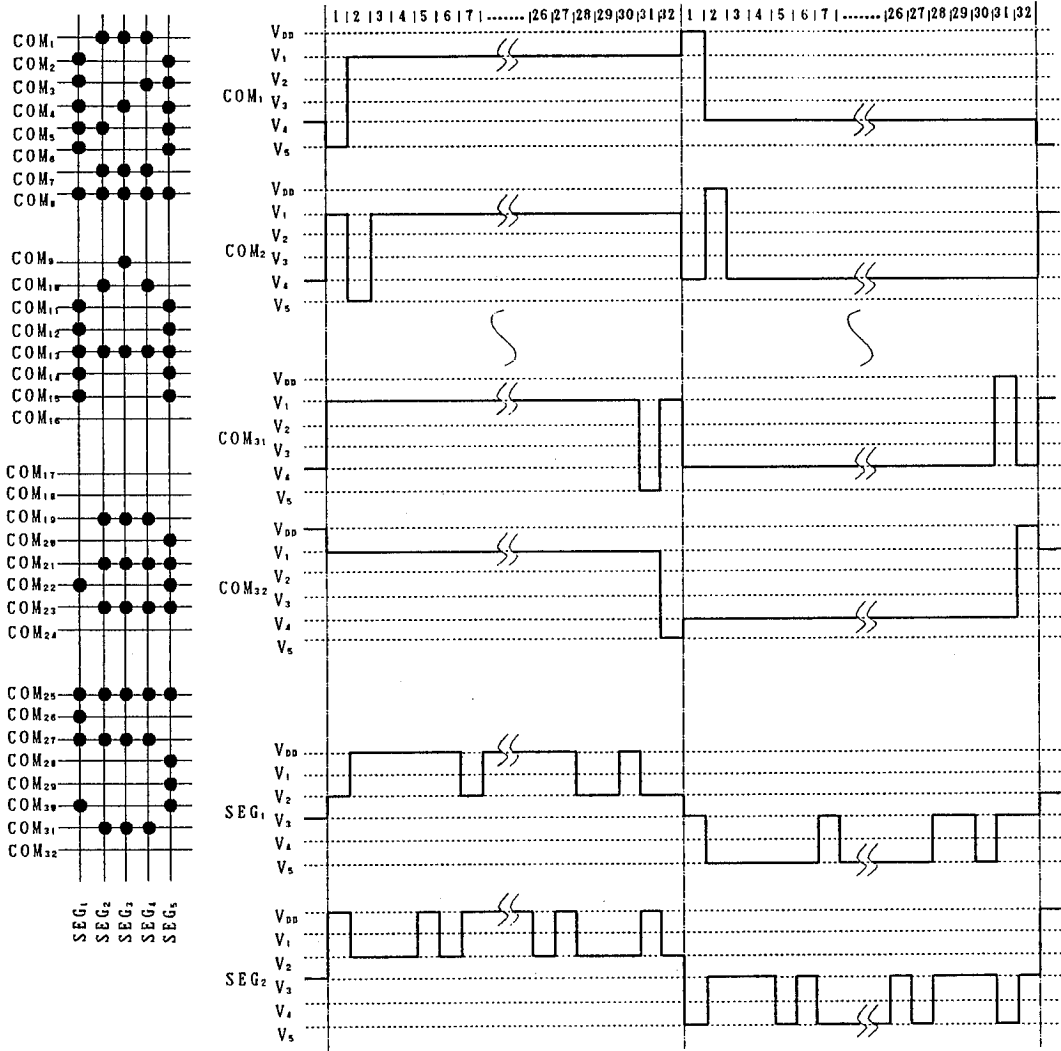

■ APPLICATION CIRCUITS

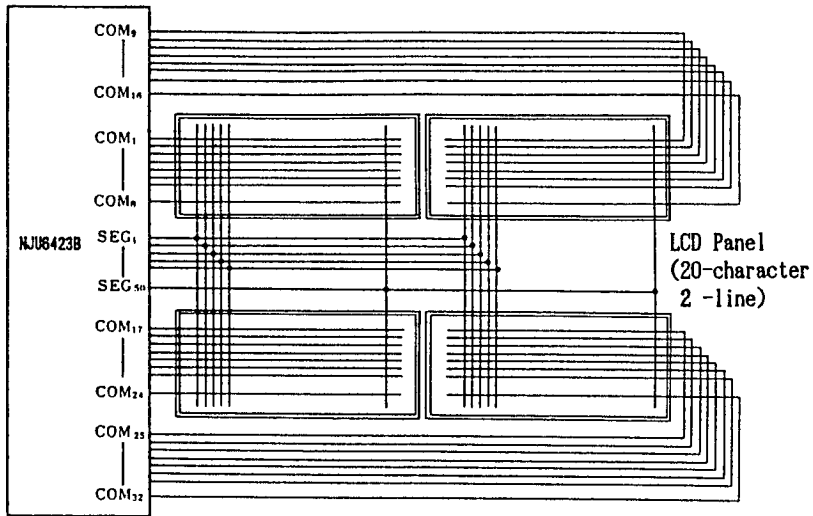

(a) 5 x 7 dots, 20-character 2-line display example (1/6.7 Bias, 1/32 Duty)

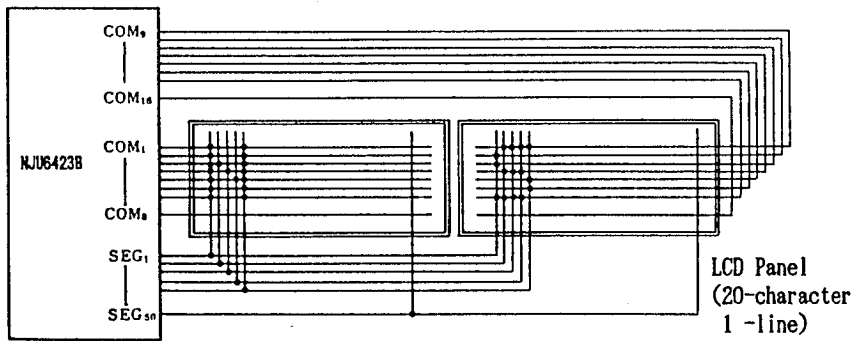

(b) 5 x 7 dots, 20-character 1-line display example (1/6.7 Bias, 1/16 Duty)

5

MEMO

[CAUTION]

The specifications on this databook are only given for information, without any guarantee as regards either mistakes or omissions. The application circuits in this databook are described only to show representative usages of the product and not intended for the guarantee or permission of any right including the industrial rights.