

NM25C040

4K-Bit Serial CMOS EEPROM

(Serial Peripheral Interface (SPI) Synchronous Bus)

General Description

The NM25C040 is a 4096-bit CMOS EEPROM with an SPI compatible serial interface. The NM25C040 is designed for data storage in applications requiring both non-volatile memory and in-system data updates. This EEPROM is well suited for applications using the 68HC11 series of microcontrollers that support the SPI interface for high speed communication with peripheral devices via a serial bus to reduce pin count. The NM25C040 is implemented in Fairchild Semiconductor's floating gate CMOS process that provides superior endurance and data retention.

The serial data transmission of this device requires four signal lines to control the device operation: Chip Select (CS), Clock (SCK), Data In (SI), and Serial Data Out (SO). All programming cycles are completely self-timed and do not require an erase before WRITE.

BLOCK WRITE protection is provided by programming the STATUS REGISTER with one of four levels of write protection. Additionally, separate WRITE enable and WRITE disable instructions are provided for data protection.

Hardware data protection is provided by the \overline{WP} pin to protect against inadvertent programming. The HOLD pin allows the serial communication to be suspended without resetting the serial sequence.

Features

- 2.1 MHz clock rate @ 2.7V to 5.5V
- 4096 bits organized as 512 x 8
- Multiple chips on the same 3-wire bus with separate chip select lines
- Self-timed programming cycle
- Simultaneous programming of 1 to 4 bytes at a time
- Status register can be polled during programming to monitor READY/BUSY
- Write Protect (\overline{WP}) pin and write disable instruction for both hardware and software write protection
- Block write protect feature to protect against accidental writes
- Endurance: 1,000,000 data changes
- Data retention greater than 40 years
- Packages available: 8-pin DIP, 8-pin SO, or 8-pin TSSOP

Block Diagram

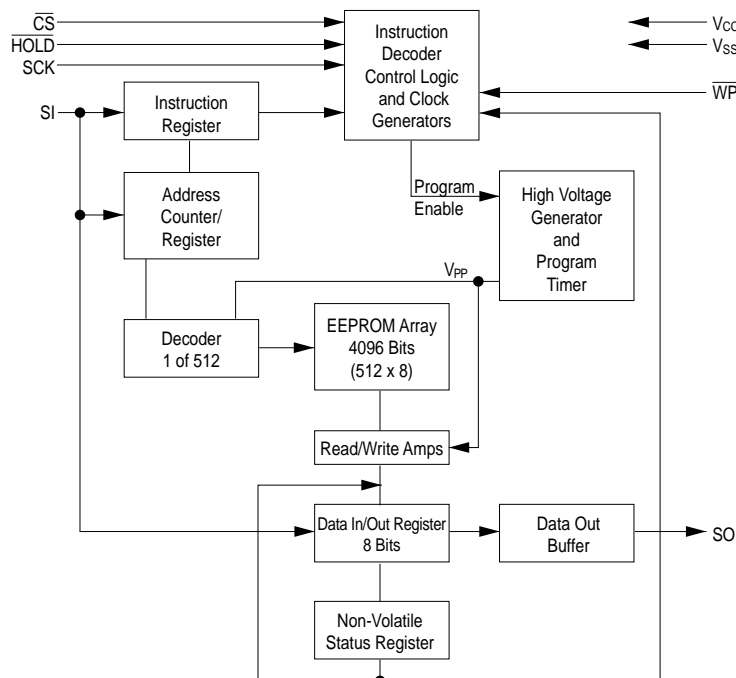

DS012401-1

Connection Diagram

Dual-In-Line Package (N), SO Package (M8),
and TSSOP Package (MT8)

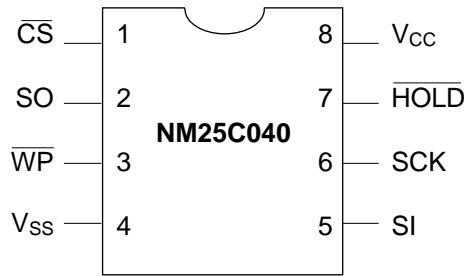

DS012401-2

Top View

See Package Number N08E (N), M08A (M8), and MTC08 (MT8)

Pin Names

$\overline{\text{CS}}$	Chip Select Input
SO	Serial Data Output
$\overline{\text{WP}}$	Write Protect
V_{SS}	Ground
SI	Serial Data Input
SCK	Serial Clock Input
$\overline{\text{HOLD}}$	Suspends Serial Data
V_{CC}	Power Supply

Ordering Information

NM	25	C	XX	LZ	E	XX	Letter	Description
							Package	N M8 MT8
							Temp. Range	None V E
							Voltage Operating Range	Blank L LZ
							Density/Mode	040 C W
							Interface	25
							NM	Fairchild Nonvolatile Memory Prefix

Standard Voltage $4.5 \leq V_{CC} \leq 5.5V$ Specifications

Absolute Maximum Ratings (Note 1)

Ambient Storage Temperature	-65°C to +150°C
All Input or Output Voltage with Respect to Ground	+6.5V to -0.3V
Lead Temp. (Soldering, 10 sec.)	+300°C
ESD Rating	2000V

Operating Conditions

Ambient Operating Temperature	NM25C040	0°C to +70°C
	NM25C040E	-40°C to +85°C
	NM25C040V	-40°C to +125°C
Power Supply (V_{CC})		4.5V to 5.5V

DC and AC Electrical Characteristics $4.5V \leq V_{CC} \leq 5.5V$ (unless otherwise specified)

Symbol	Parameter	Conditions	Min	Max	Units
I_{CC}	Operating Current	$\overline{CS} = V_{IL}$		3	mA
I_{CCSB}	Standby Current	$\overline{CS} = V_{CC}$		50	μA
I_{IL}	Input Leakage	$V_{IN} = 0$ to V_{CC}	-1	+1	μA
I_{OL}	Output Leakage	$V_{OUT} = GND$ to V_{CC}	-1	+1	μA
V_{IL}	CMOS Input Low Voltage		-0.3	$V_{CC} * 0.3$	V
V_{IH}	CMOS Input High Voltage		$0.7 * V_{CC}$	$V_{CC} + 0.3$	V
V_{OL}	Output Low Voltage	$I_{OL} = 1.6$ mA		0.4	V
V_{OH}	Output High Voltage	$I_{OH} = -0.8$ mA	$V_{CC} - 0.8$		V
f_{OP}	SCK Frequency			2.1	MHz
t_{RI}	Input Rise Time			2.0	μs
t_{FI}	Input Fall Time			2.0	μs
t_{CLH}	Clock High Time	(Note 2)	190		ns
t_{CLL}	Clock Low Time	(Note 2)	190		ns
t_{CSH}	Min \overline{CS} High Time	(Note 3)	240		ns
t_{CSS}	\overline{CS} Setup Time		240		ns
t_{DIS}	Data Setup Time		100		ns
t_{HDS}	HOLD Setup Time		90		ns
t_{CSN}	\overline{CS} Hold Time		240		ns
t_{DIN}	Data Hold Time		100		ns
t_{HDN}	HOLD Hold Time		90		ns
t_{PD}	Output Delay	$C_L = 200$ pF		240	ns
t_{DH}	Output Hold Time		0		ns
t_{LZ}	HOLD to Output Low Z			100	ns
t_{DF}	Output Disable Time	$C_L = 200$ pF		240	ns
t_{HZ}	HOLD to Output High Z			100	ns
t_{WP}	Write Cycle Time	1–4 Bytes		10	ms

Capacitance $T_A = 25^\circ C$, $f = 2.1/1$ MHz (Note 4)

Symbol	Test	Typ	Max	Units
C_{OUT}	Output Capacitance	3	8	pF
C_{IN}	Input Capacitance	2	6	pF

AC Test Conditions

Output Load	$C_L = 200$ pF
Input Pulse Levels	$0.1 * V_{CC} - 0.9 * V_{CC}$
Timing Measurement Reference Level	$0.3 * V_{CC} - .07 * V_{CC}$

Note 1: Stress above those listed under "Absolute Maximum Ratings" may cause permanent damage to the device. This is a stress rating only, and functional operation of the device at these or any other conditions above those indicated in the operational sections of the specification is not implied. Exposure to absolute maximum rating conditions for extended periods may affect device reliability.

Note 2: The f_{OP} frequency specification specifies a minimum clock period of $1/f_{OP}$. Therefore, for every f_{OP} clock cycle, $t_{CLH} + t_{CLL}$ must be equal to or greater than $1/f_{OP}$. For example, if the 2.1MHz period = 476ns and $t_{CLH} = 190$ ns, t_{CLL} must be 286ns.

Note 3: \overline{CS} must be brought high for a minimum of t_{CSH} between consecutive instruction cycles.

Note 4: This parameter is periodically sampled and not 100% tested.

Low Voltage $2.7V \leq V_{CC} \leq 4.5V$ Specifications

Absolute Maximum Ratings (Note 5)

Ambient Storage Temperature	-65°C to +150°C
All Input or Output Voltage with Respect to Ground	+6.5V to -0.3V
Lead Temp. (Soldering, 10 sec.)	+300°C
ESD Rating	2000V

Operating Conditions

Ambient Operating Temperature	NM25C040L/LZ	0°C to +70°C
	NM25C040LE/LZE	-40°C to +85°C
	NM25C040LV	-40°C to +125°C
Power Supply (V_{CC})		2.7V–4.5V

DC and AC Electrical Characteristics $2.7V \leq V_{CC} \leq 4.5V$ (unless otherwise specified)

Symbol	Parameter	Part	Conditions	25C040L/LE 25C040LZ/ZE		25C040LV		Units
				Min.	Max.	Min	Max	
I_{CC}	Operating Current		$\overline{CS} = V_{IL}$		3		3	mA
I_{CCSB}	Standby Current	L LZ	$CS = V_{CC}$		10 1		10 N/A	μA μA
I_{IL}	Input Leakage		$V_{IN} = 0$ to V_{CC}	-1	1	-1	1	μA
I_{OL}	Output Leakage		$V_{OUT} = GND$ to V_{CC}	-1	1	-1	1	μA
V_{IL}	Input Low Voltage			-0.3	$V_{CC} * 0.3$	-0.3	$V_{CC} * 0.3$	V
V_{IH}	Input High Voltage			$V_{CC} * 0.7$	$V_{CC} + 0.3$	$V_{CC} * 0.7$	$V_{CC} + 0.3$	V
V_{OL}	Output Low Voltage		$I_{OL} = 0.8$ mA		0.4		0.4	V
V_{OH}	Output High Voltage		$I_{OH} = -0.8$ mA	$V_{CC} - 0.8$		$V_{CC} - 0.8$		V
f_{OP}	SCK Frequency				1.0		1.0	MHz
t_{RI}	Input Rise Time				2.0		2.0	μs
t_{FI}	Input Fall Time				2.0		2.0	μs
t_{CLH}	Clock High Time		(Note 6)	410		410		ns
t_{CLL}	Clock Low Time		(Note 6)	410		410		ns
t_{CSH}	Min. \overline{CS} High Time		(Note 7)	500		500		ns
t_{CSS}	\overline{CS} Setup Time			500		500		ns
t_{DIS}	Data Setup Time			100		100		ns
t_{HDS}	HOLD Setup Time			240		240		ns
t_{CSN}	\overline{CS} Hold Time			500		500		ns
t_{DIN}	Data Hold Time			100		100		ns
t_{HDN}	HOLD Hold Time			240		240		ns
t_{PD}	Output Delay		$C_L = 200$ pF		500		500	ns
t_{DH}	Output Hold Time			0		0		ns
t_{LZ}	HOLD Output Low Z				240		240	ns
t_{DF}	Output Disable Time		$C_L = 200$ pF		500		500	ns
t_{HZ}	HOLD to Output Hi Z				240		240	ns
t_{WP}	Write Cycle Time		1-4 Bytes		15		15	ms

Capacitance $T_A = 25^\circ C$, $f = 2.1/1$ MHz (Note 8)

Symbol	Test	Typ	Max	Units
C_{OUT}	Output Capacitance	3	8	pF
C_{IN}	Input Capacitance	2	6	pF

AC Test Conditions

Output Load	$C_L = 200$ pF
Input Pulse Levels	$0.1 * V_{CC} - 0.9 * V_{CC}$
Timing Measurement Reference Level	$0.3 * V_{CC} - 0.7 * V_{CC}$

Note 5: Stress above those listed under "Absolute Maximum Ratings" may cause permanent damage to the device. This is a stress rating only, and functional operation of the device at these or any other conditions above those indicated in the operational sections of the specification is not implied. Exposure to absolute maximum rating conditions for extended periods may affect device reliability.

Note 6: The f_{OP} frequency specification specifies a minimum clock period of $1/f_{OP}$. Therefore, for every f_{OP} clock cycle, $t_{CLH} + t_{CLL}$ must be equal to or greater than $1/f_{OP}$. For example, if the 2.1MHz period = 476ns and $t_{CLH} = 190$ ns, t_{CLL} must be 286ns.

Note 7: \overline{CS} must be brought high for a minimum of t_{CSH} between consecutive instruction cycles.

Note 8: This parameter is periodically sampled and not 100% tested.

AC Test Conditions (Continued)

FIGURE 1. Synchronous Data Timing Diagram

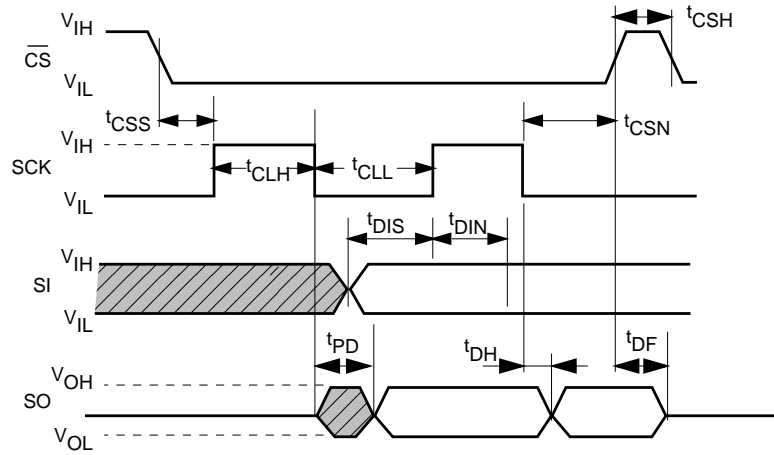

DS012401-3

FIGURE 2. HOLD Timing

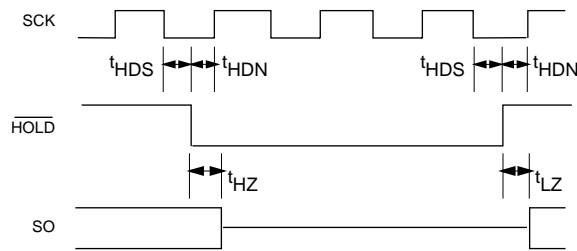

DS012401-6

FIGURE 3. SPI Serial Interface

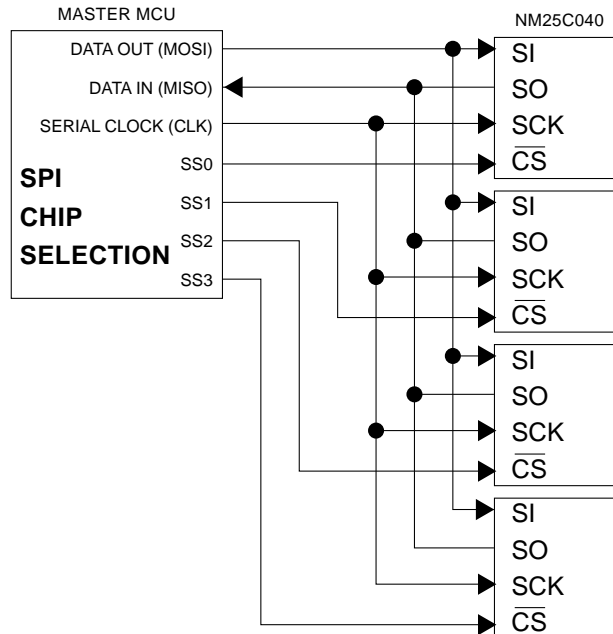

DS012401-4

Functional Description

TABLE 1. Instruction Set

Instruction Name	Instruction Opcode	Operation
WREN	00000110	Set Write Enable Latch
WRDI	00000100	Reset Write Enable Latch
RDSR	00000101	Read Status Register
WRSR	00000001	Write Status Register
READ	0000A011	Read Data from Memory Array
WRITE	0000A010	Write Data to Memory Array

Note: As the NM25C040 requires 9 address bits ($4,096 \div 8 = 512 \text{ bytes} = 2^9$), the 9th bit (for R/W instructions) is inputted in the Instruction Set Byte in bit I₃. This convention only applies to 4K SPI protocol.

MASTER: The device that generates the serial clock is designated as the master. The NM25C040 can never function as a master.

SLAVE: The NM25C040 always operates as a slave as the serial clock pin is always an input.

TRANSMITTER/RECEIVER: The NM25C040 has separate pins for data transmission (SO) and reception (SI).

MSB: The Most Significant Bit is the first bit transmitted and received.

CHIP SELECT: The chip is selected when pin $\overline{\text{CS}}$ is low. When the chip is *not* selected, data will not be accepted from pin SI, and the output pin SO is in high impedance.

SERIAL OP-CODE: The first byte transmitted after the chip is selected with $\overline{\text{CS}}$ going low contains the op-code that defines the operation to be performed.

PROTOCOL: When connected to the SPI port of a 68HC11 microcontroller, the NM25C040 accepts a clock phase of 0 and a clock polarity of 0. The SPI protocol for this device defines the byte transmitted on the SI and SO data lines for proper chip operation. See Figure 4.

FIGURE 4. SPI Protocol

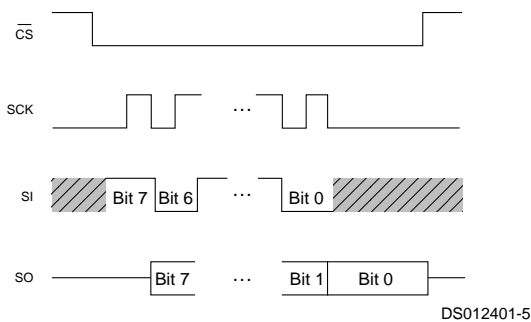

Data is clocked in on the positive SCK edge and out on the negative SCK edge.

HOLD: The $\overline{\text{HOLD}}$ pin is used in conjunction with the $\overline{\text{CS}}$ to select the device. Once the device is selected and a serial sequence is underway, $\overline{\text{HOLD}}$ may be forced low to suspend further serial communication with the device without resetting the serial sequence. Note that $\overline{\text{HOLD}}$ must be brought low while the SCK pin is low. The device must remain selected during this sequence. To resume serial communication $\overline{\text{HOLD}}$ is brought high while the SCK pin is low. The SO pin is at a high impedance state during $\overline{\text{HOLD}}$.

INVALID OP-CODE: After an invalid code is received, no data is shifted into the NM25C040, and the SO data output pin remains high impedance until a new $\overline{\text{CS}}$ falling edge reinitializes the serial communication. See Figure 5.

FIGURE 5. Invalid Op-Code

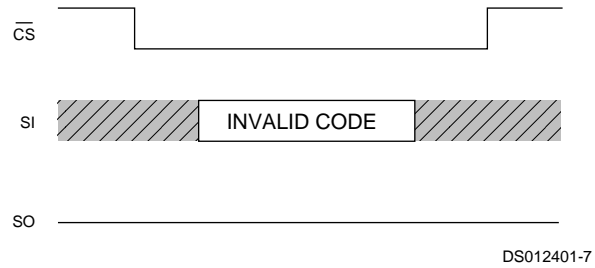

Functional Description (Continued)

READ SEQUENCE: Reading the memory via the serial SPI link requires the following sequence. The \overline{CS} line is pulled low to select the device. The READ op-code (which includes A8) is transmitted on the SI line followed by the byte address (A7–A0) to be read. After this is done, data on the SI line becomes don't care. The data (D7–D0) at the address specified is then shifted out on the SO line. If only one byte is to be read, the CS line can be pulled back to the high level. It is possible to continue the READ sequence as the byte address is automatically incremented and data will continue to be shifted out. When the highest address is reached (1FF), the address counter rolls over to lowest address (000) allowing the entire memory to be read in one continuous READ cycle. See Figure 6.

FIGURE 6. Read Sequence

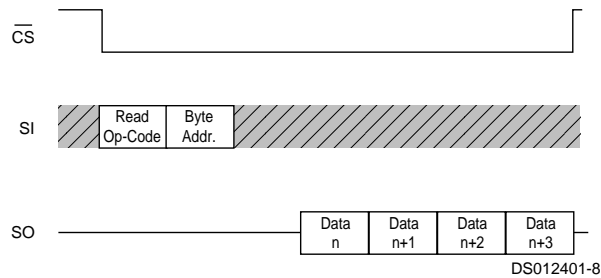

READ STATUS REGISTER (RDSR) : The Read Status Register (RDSR) instruction provides access to the status register is used to interrogate the READY/BUSY and WRITE ENABLE status of the chip. Two non-volatile status register bits are used to select one of four levels of BLOCK WRITE PROTECTION. The status register format is shown in Table 2.

TABLE 2. Status Register Format

Bit 7	Bit 6	Bit 5	Bit 4	Bit 3	Bit 2	Bit 1	Bit 0
X	X	X	X	BP1	BP0	WEN	RDY

X = Don't Care.

Status register Bit 0 = 0 (RDY) indicates that the device is READY; Bit 0 = 1 indicates that a program cycle is in progress. Bit 1 = 0 (WEN) indicates that the device is not WRITE ENABLED; Bit 1 = 1 indicates that the device is WRITE ENABLED. Non-volatile status register Bits 2 and 3 (BP0 and BP1) indicate the level of BLOCK WRITE PROTECTION selected. The block write protection levels and corresponding status register control bits are shown in Table 3. **Note that if a RDSR instruction is executed during a programming cycle only the RDY bit is valid. All other bits are 1s.** See Figure 7.

FIGURE 7. Read Status

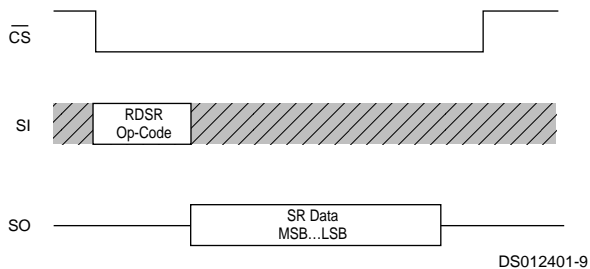
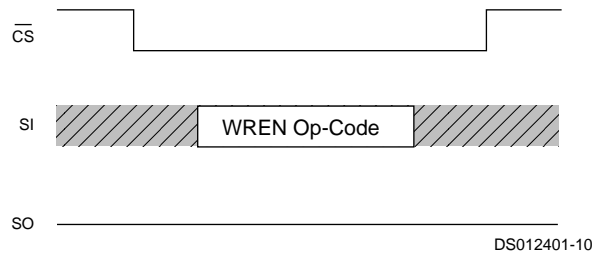

TABLE 3. Block Write Protection Levels

Level	Status Register Bits		Array Address Protected
	BP1	BP0	
0	0	0	None
1	0	1	180-1FF
2	1	0	100-1FF
3	1	1	000-1FF

WRITE ENABLE (WREN): When V_{CC} is applied to the chip, it “powers up” in the write disable state. Therefore, all programming modes must be preceded by a WRITE ENABLE (WREN) instruction. At the completion of a WRITE or WRSR cycle the device is automatically returned to the write disable state. Note that a WRITE DISABLE (WRDI) instruction will also return the device to the write disable state. See Figure 8.

FIGURE 8. Write Enable



WRITE DISABLE (WRDI): To protect against accidental data disturbance the WRITE DISABLE (WRDI) instruction disables all programming modes. See Figure 9.

FIGURE 9. Write Disable

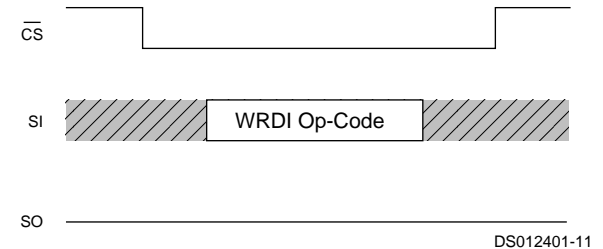

WRITE SEQUENCE: To program the device, the WRITE PROTECT (WP) pin must be held high and two separate instructions must be executed. The chip must first be write enabled via the WRITE ENABLE instruction and then a WRITE instruction must be executed. Moreover, the address of the memory location(s) to be programmed must be outside the protected address field selected by the Block Write Protection Level. See Table 3.

A WRITE command requires the following sequence. The \overline{CS} line is pulled low to select the device, then the WRITE op-code (which includes A8) is transmitted on the SI line followed by the high order address byte (A10-A8) and the byte address (A7–A0) and the corresponding data (D7–D0) to be written. Programming will start after the CS pin is forced back to a high level. Note that the LOW to HIGH transition of the CS pin must occur during the SCK low time immediately after clocking in the D0 data bit. See Figure 10.

Functional Description (Continued)

FIGURE 10. Write Sequence

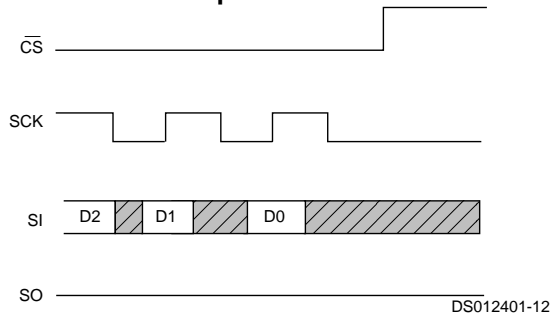

The READY/BUSY status of the device can be determined by executing a READ STATUS REGISTER (RDSR) instruction. Bit 0 = 1 indicates that the WRITE cycle is still in progress and Bit 0 = 0 indicates that the WRITE cycle has ended. During the WRITE programming cycle (Bit 0 = 1) only the READ STATUS REGISTER instruction is enabled.

The NM25C040 is capable of a 4 byte PAGE WRITE operation. After receipt of each byte of data the two low order address bits are internally incremented by one. The seven high order bits of the address will remain constant. If the master should transmit more than 4 bytes of data, the address counter will “roll over,” and the previously loaded data will be reloaded. See Figure 11.

FIGURE 11. 4 Byte Page Write

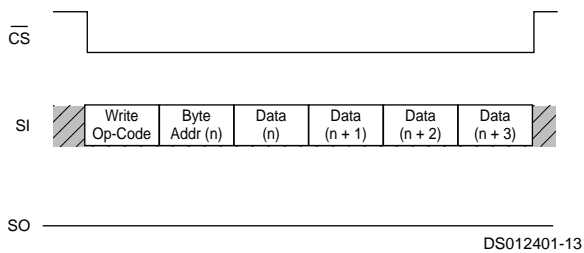

At the completion of a WRITE cycle the device is automatically returned to the write disable state.

If the device is not WRITE enabled, the device will ignore the WRITE instruction and return to the standby state when CS is forced high. A new CS falling edge is required to re-initialize the serial communication.

WRITE STATUS REGISTER (WRSR): The WRITE STATUS REGISTER (WRSR) instruction is used to program the non-volatile status register Bits 2 and 3 (BP0 and BP1). The WRITE PROTECT (WP) pin must be held high and two separate instructions must be executed. The chip must first be write enabled via the WRITE ENABLE instruction and then a WRSR instruction must be executed.

The WRSR command requires the following sequence. The CS line is pulled low to select the device and then the WRSR op-code is transmitted on the SI line followed by the data to be programmed. See Figure 12.

FIGURE 12. Write Status Register

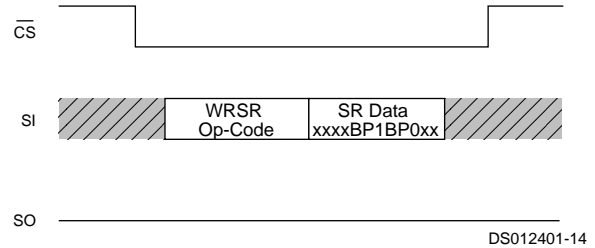

Note that the first four bits are don't care bits followed by BP1 and BP0 then two additional don't care bits. Programming will start after the CS pin is forced back to a high level. As in the WRITE instruction the LOW to HIGH transition of the CS pin must occur during the SCK low time immediately after clocking in the last don't care bit. See Figure 13.

FIGURE 13. Start WRSR Condition

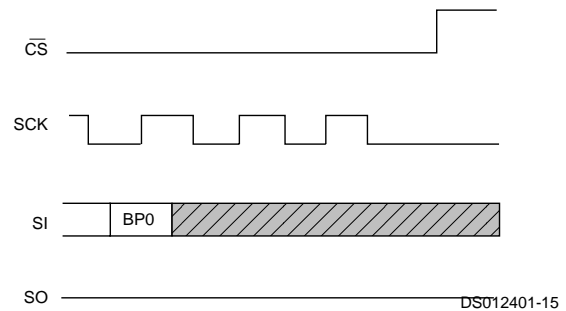

The READY/BUSY status of the device can be determined by executing a READ STATUS REGISTER (RDSR) instruction. Bit 0 = 1 indicates that the WRSR cycle is still in progress and Bit 0 = 0 indicates that the WRSR cycle has ended.

At the completion of a WRITE cycle the device is automatically returned to the write disable state.

Physical Dimensions inches (millimeters) unless otherwise noted

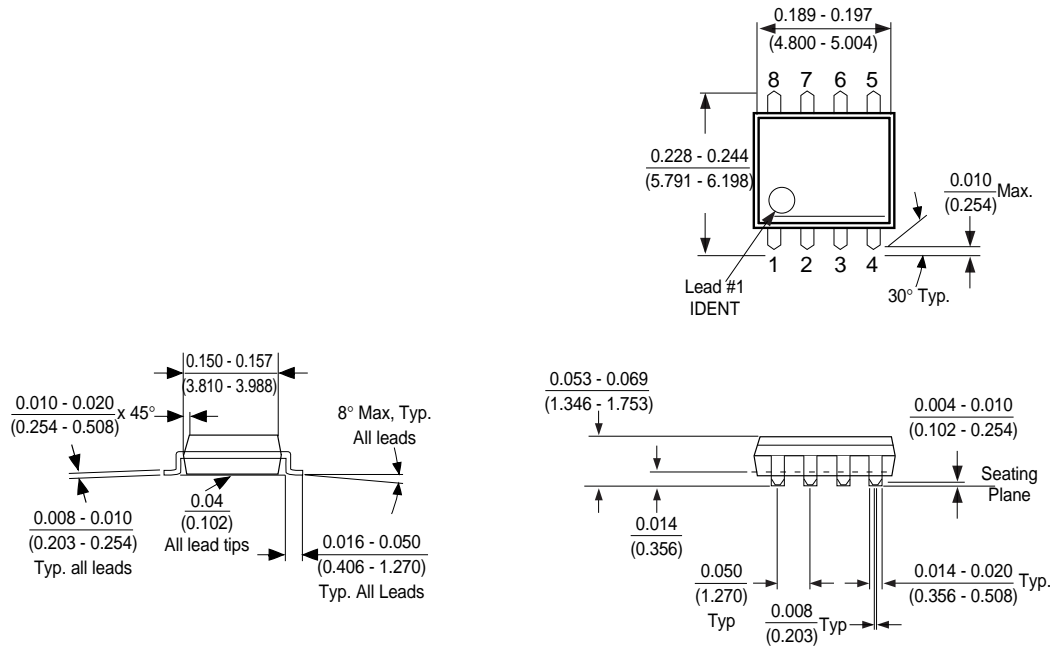

Molded Small Out-Line Package (M8)
Package Number M08A

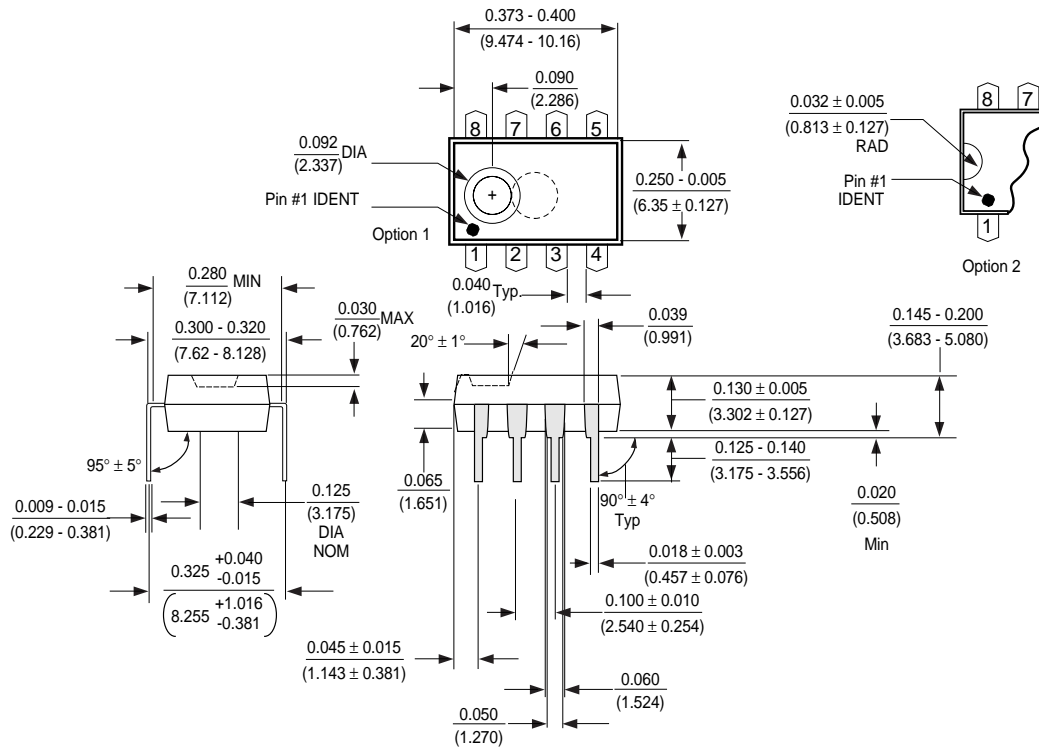

Molded Dual-In-Line Package (N)
Package Number N08E

Physical Dimensions inches (millimeters) unless otherwise noted

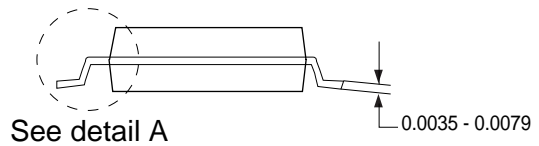
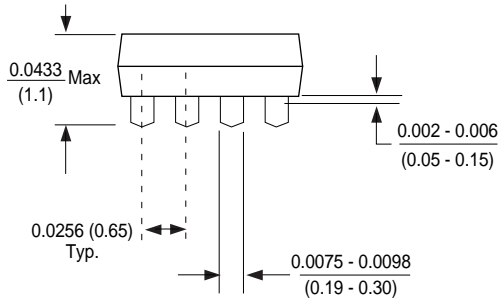
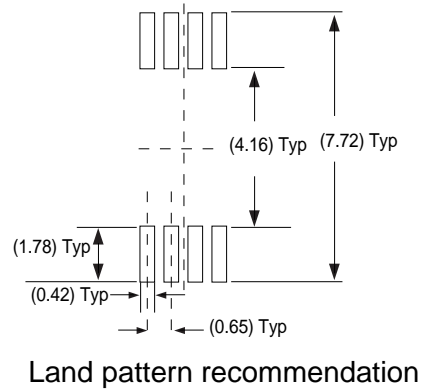
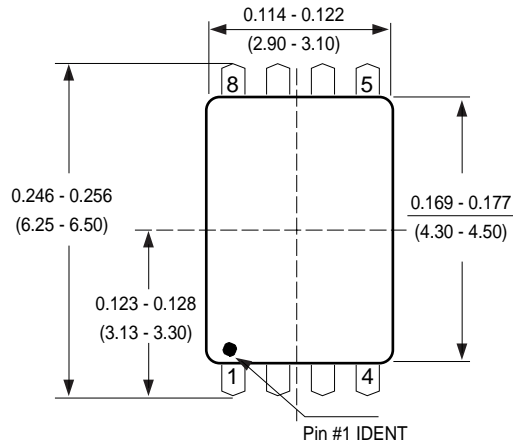

Note: Metal mask option for 16-byte page size.

DETAIL A
Typ. Scale: 40X

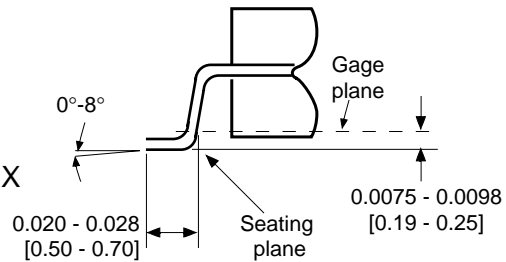

8-Pin Molded TSSOP, JEDEC (MT8)
Package Number MTC08

Life Support Policy

Fairchild's products are not authorized for use as critical components in life support devices or systems without the express written approval of the President of Fairchild Semiconductor Corporation. As used herein:

- Life support devices or systems are devices or systems which, (a) are intended for surgical implant into the body, or (b) support or sustain life, and whose failure to perform, when properly used in accordance with instructions for use provided in the labeling, can be reasonably expected to result in a significant injury to the user.
- A critical component is any component of a life support device or system whose failure to perform can be reasonably expected to cause the failure of the life support device or system, or to affect its safety or effectiveness.

Fairchild Semiconductor Americas
Customer Response Center
Tel: 1-888-522-5372

Fairchild Semiconductor Europe
Deutsch Tel: +44 (0) 1793-856858
English Tel: +49 (0) 8141-6102-0
Français Tel: +44 (0) 1793-856856
Italiano Tel: +33 (0) 1-6930-3696
Tel: +39 (0) 2-249111-1

Fairchild Semiconductor Hong Kong
8/F, Room 808, Empire Centre
68 Mody Road, Tsimshatsui East
Kowloon, Hong Kong
Tel: +852-2722-8338
Fax: +852-2722-8383

Fairchild Semiconductor Japan Ltd.
4F, Natsume Bldg.
2-18-6, Yushima, Bunkyo-ku
Tokyo, 113-0034 Japan
Tel: 81-3-3818-8840
Fax: 81-3-3818-8841