

# NSDEMP11XV6T1, NSDEMP11XV6T5

## Common Anode Quad Array Switching Diode

These Common Anode Epitaxial Planar QUAD Diodes are designed for use in ultra high speed switching applications. The NSDEMP11XV6T1 device is housed in the SOT-563 package which is designed for low power surface mount applications, where board space is at a premium.

### Features

- Fast  $t_{rr}$
- Low  $C_D$
- These are Pb-Free Devices

### MAXIMUM RATINGS ( $T_A = 25^\circ\text{C}$ )

Rating	Symbol	Value	Unit
Reverse Voltage	$V_R$	80	Vdc
Peak Reverse Voltage	$V_{RM}$	80	Vdc
Forward Current	$I_F$	100	mAdc
Peak Forward Current	$I_{FM}$	300	mAdc
Peak Forward Surge Current	$I_{FSM}$ (Note 1)	2.0	Adc

### THERMAL CHARACTERISTICS

Characteristic (One Junction Heated)	Symbol	Max	Unit
Total Device Dissipation $T_A = 25^\circ\text{C}$	$P_D$	357 (Note 2)	mW
Derate above $25^\circ\text{C}$		2.9 (Note 2)	mW/ $^\circ\text{C}$
Thermal Resistance, Junction-to-Ambient	$R_{\theta JA}$	350 (Note 2)	$^\circ\text{C}/\text{W}$
Characteristic (Both Junctions Heated)	Symbol	Max	Unit
Total Device Dissipation $T_A = 25^\circ\text{C}$	$P_D$	500 (Note 2)	mW
Derate above $25^\circ\text{C}$		4.0 (Note 2)	mW/ $^\circ\text{C}$
Thermal Resistance, Junction-to-Ambient	$R_{\theta JA}$	250 (Note 2)	$^\circ\text{C}/\text{W}$
Junction and Storage Temperature	$T_J, T_{stg}$	-55 to +150	$^\circ\text{C}$

Stresses exceeding Maximum Ratings may damage the device. Maximum Ratings are stress ratings only. Functional operation above the Recommended Operating Conditions is not implied. Extended exposure to stresses above the Recommended Operating Conditions may affect device reliability.

1.  $t = 1 \mu\text{s}$
2. FR-4 @ Minimum Pad



ON Semiconductor®

<http://onsemi.com>

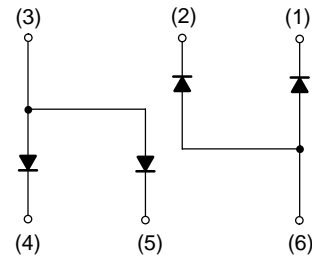

SOT-563  
CASE 463A  
PLASTIC

### MARKING DIAGRAM

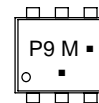

P9 = Device Code  
M = Date Code  
▪ = Pb-Free Package  
(Note: Microdot may be in either location)

### ORDERING INFORMATION

Device	Package	Shipping†
NSDEMP11XV6T1	SOT-563*	4000/Tape & Reel
NSDEMP11XV6T1G	SOT-563*	4000/Tape & Reel
NSDEMP11XV6T5	SOT-563*	8000/Tape & Reel
NSDEMP11XV6T5G	SOT-563*	8000/Tape & Reel

†For information on tape and reel specifications, including part orientation and tape sizes, please refer to our Tape and Reel Packaging Specifications Brochure, BRD8011/D.

\*This package is inherently Pb-Free.

# NSDEMP11XV6T1, NSDEMP11XV6T5

## ELECTRICAL CHARACTERISTICS ( $T_A = 25^\circ\text{C}$ )

Characteristic	Symbol	Condition	Min	Max	Unit
Reverse Voltage Leakage Current	$I_R$	$V_R = 70\text{ V}$	-	0.1	$\mu\text{A}$ dc
Forward Voltage	$V_F$	$I_F = 100\text{ mA}$	-	1.2	Vdc
Reverse Breakdown Voltage	$V_R$	$I_R = 100\text{ }\mu\text{A}$	0	-	Vdc
Diode Capacitance	$C_D$	$V_R = 6.0\text{ V}, f = 1.0\text{ MHz}$	-	3.5	pF
Reverse Recovery Time	$t_{rr}$ (Note 3)	$I_F = 5.0\text{ mA}, V_R = 6.0\text{ V}, R_L = 100\text{ }\Omega, I_{rr} = 0.1 I_R$	-	4.0	ns

3.  $t_{rr}$  Test Circuit for NSDEMP11XV6T1 in Figure 4.

## TYPICAL ELECTRICAL CHARACTERISTICS

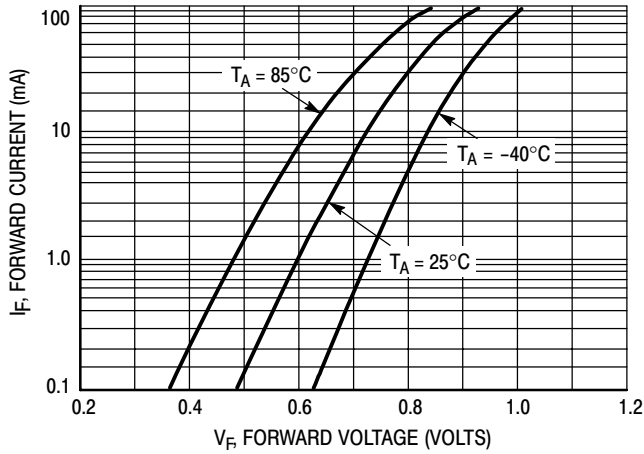

Figure 1. Forward Voltage

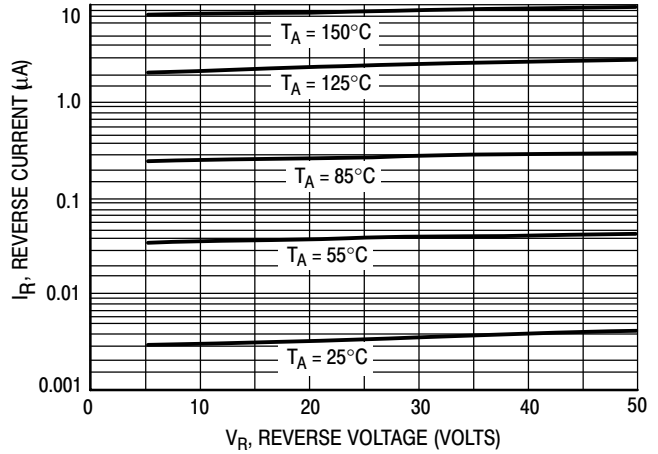

Figure 2. Reverse Current

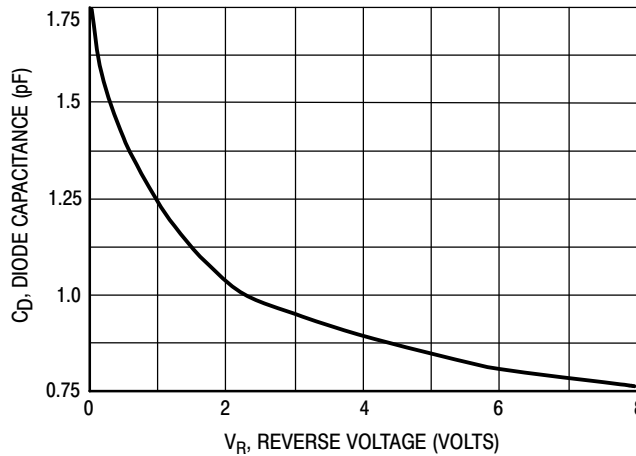

Figure 3. Diode Capacitance

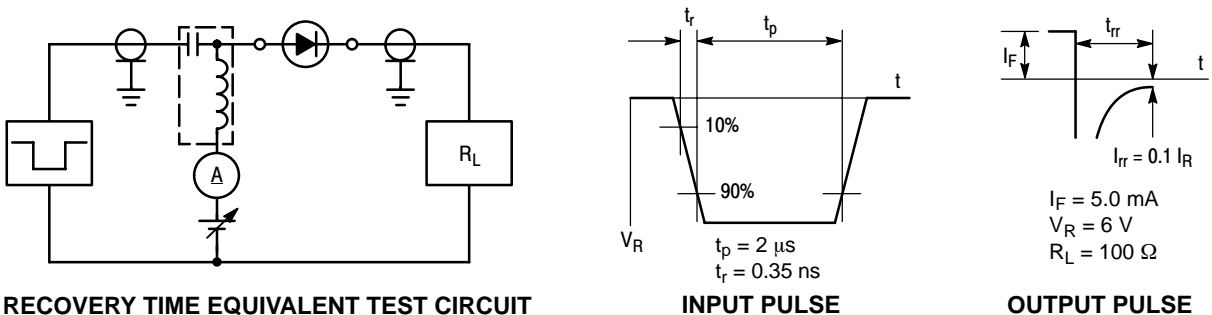
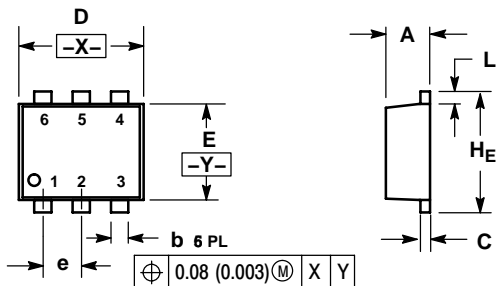

Figure 4. Reverse Recovery Time Test Circuit for the NSDEMP11XV6T1

# NSDEMP11XV6T1, NSDEMP11XV6T5

## PACKAGE DIMENSIONS

SOT-563, 6 LEAD  
CASE 463A-01  
ISSUE F



NOTES:

1. DIMENSIONING AND TOLERANCING PER ANSI Y14.5M, 1982.
2. CONTROLLING DIMENSION: MILLIMETERS
3. MAXIMUM LEAD THICKNESS INCLUDES LEAD FINISH THICKNESS. MINIMUM LEAD THICKNESS IS THE MINIMUM THICKNESS OF BASE MATERIAL.

DIM	MILLIMETERS			INCHES		
	MIN	NOM	MAX	MIN	NOM	MAX
A	0.50	0.55	0.60	0.020	0.021	0.023
b	0.17	0.22	0.27	0.007	0.009	0.011
C	0.08	0.12	0.18	0.003	0.005	0.007
D	1.50	1.60	1.70	0.059	0.062	0.066
E	1.10	1.20	1.30	0.043	0.047	0.051
e	0.5 BSC			0.02 BSC		
L	0.10	0.20	0.30	0.004	0.008	0.012
H <sub>E</sub>	1.50	1.60	1.70	0.059	0.062	0.066

### SOLDERING FOOTPRINT\*

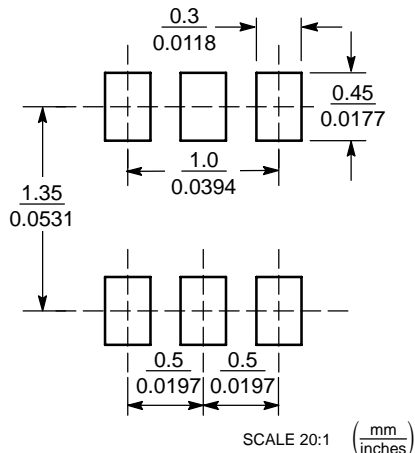

\*For additional information on our Pb-Free strategy and soldering details, please download the ON Semiconductor Soldering and Mounting Techniques Reference Manual, SOLDERRM/D.

ON Semiconductor and are registered trademarks of Semiconductor Components Industries, LLC (SCILLC). SCILLC reserves the right to make changes without further notice to any products herein. SCILLC makes no warranty, representation or guarantee regarding the suitability of its products for any particular purpose, nor does SCILLC assume any liability arising out of the application or use of any product or circuit, and specifically disclaims any and all liability, including without limitation special, consequential or incidental damages. "Typical" parameters which may be provided in SCILLC data sheets and/or specifications can and do vary in different applications and actual performance may vary over time. All operating parameters, including "Typicals" must be validated for each customer application by customer's technical experts. SCILLC does not convey any license under its patent rights nor the rights of others. SCILLC products are not designed, intended, or authorized for use as components in systems intended for surgical implant into the body, or other applications intended to support or sustain life, or for any other application in which the failure of the SCILLC product could create a situation where personal injury or death may occur. Should Buyer purchase or use SCILLC products for any such unintended or unauthorized application, Buyer shall indemnify and hold SCILLC and its officers, employees, subsidiaries, affiliates, and distributors harmless against all claims, costs, damages, and expenses, and reasonable attorney fees arising out of, directly or indirectly, any claim of personal injury or death associated with such unintended or unauthorized use, even if such claim alleges that SCILLC was negligent regarding the design or manufacture of the part. SCILLC is an Equal Opportunity/Affirmative Action Employer. This literature is subject to all applicable copyright laws and is not for resale in any manner.

### PUBLICATION ORDERING INFORMATION

**LITERATURE FULFILLMENT:**  
Literature Distribution Center for ON Semiconductor  
P.O. Box 5163, Denver, Colorado 80217 USA  
Phone: 303-675-2175 or 800-344-3860 Toll Free USA/Canada  
Fax: 303-675-2176 or 800-344-3867 Toll Free USA/Canada  
Email: orderlit@onsemi.com

**N. American Technical Support:** 800-282-9855 Toll Free  
USA/Canada  
**Europe, Middle East and Africa Technical Support:**  
Phone: 421 33 790 2910  
**Japan Customer Focus Center**  
Phone: 81-3-5773-3850

**ON Semiconductor Website:** [www.onsemi.com](http://www.onsemi.com)  
**Order Literature:** <http://www.onsemi.com/orderlit>

For additional information, please contact your local Sales Representative