

NSR05T40P2

500 mA, 40 V Schottky Barrier Diode

These Schottky barrier diodes are optimized for low forward voltage drop and low leakage current that offers the most optimal power dissipation in applications. They are housed in spacing saving micro-packaging ideal for space constraint applications.

Features

- Low Forward Voltage Drop – 580 mV (Typ.) @ $I_F = 500$ mA
- Low Reverse Current – 2.0 μ A (Typ.) @ $V_R = 40$ V
- 500 mA of Continuous Forward Current
- ESD Rating: – Human Body Model: Class 3B
– Charged Device Model: Class IV
- High Switching Speed
- These Devices are Pb-Free, Halogen Free/BFR Free and are RoHS Compliant

Typical Applications

- LCD and Keypad Backlighting
- Camera Photo Flash
- Buck and Boost dc-dc Converters
- Reverse Voltage and Current Protection
- Clamping & Protection

MAXIMUM RATINGS

| Rating | Symbol | Value | Unit |
|---------------------------------------------------------------------------|-----------|------------|------|
| Reverse Voltage | V_R | 40 | V |
| Forward Current (DC) | I_F | 500 | mA |
| Forward Surge Current (60 Hz @ 1 cycle) | I_{FSM} | 3.0 | A |
| Repetitive Peak Forward Current (Pulse Wave = 1 sec, Duty Cycle = 66%) | I_{FRM} | 1.0 | A |
| ESD Rating: Human Body Model Charged Device Model | ESD | > 8 > 1 | kV |

Stresses exceeding those listed in the Maximum Ratings table may damage the device. If any of these limits are exceeded, device functionality should not be assumed, damage may occur and reliability may be affected.



ON Semiconductor®

www.onsemi.com

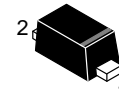

SOD-923
CASE 514AA

MARKING DIAGRAM



YK = Specific Device Code
M = Month Code
■ = Pb-Free Package



ORDERING INFORMATION

| Device | Package | Shipping† |
|---------------|----------------------|--------------------------------|
| NSR05T40P2T5G | SOD-923 (Pb-Free) | 2 mm Pitch 8000/Tape & Reel |

†For information on tape and reel specifications, including part orientation and tape sizes, please refer to our Tape and Reel Packaging Specifications Brochure, BRD8011/D.

NSR05T40P2

THERMAL CHARACTERISTICS

| Characteristic | Symbol | Min | Typ | Max | Unit |
|----------------------------------------------------------------------------------------------------------|--------------------------|-------------|-----|------------|--------------------------|
| Thermal Resistance Junction-to-Ambient (Note 1) Total Power Dissipation @ $T_A = 25^\circ\text{C}$ | $R_{\theta JA}$ P_D | | | 345 360 | $^\circ\text{C/W}$ mW |
| Thermal Resistance Junction-to-Ambient (Note 2) Total Power Dissipation @ $T_A = 25^\circ\text{C}$ | $R_{\theta JA}$ P_D | | | 175 715 | $^\circ\text{C/W}$ mW |
| Junction and Storage Temperature Range | T_J, T_{stg} | -55 to +150 | | | $^\circ\text{C}$ |

1. Mounted onto a 4 in square FR-4 board 50 mm sq. 1 oz. Cu 0.06" thick single sided. Operating to steady state.
2. Mounted onto a 4 in square FR-4 board 650 mm sq. 1 oz. Cu 0.06" thick single sided. Operating to steady state.

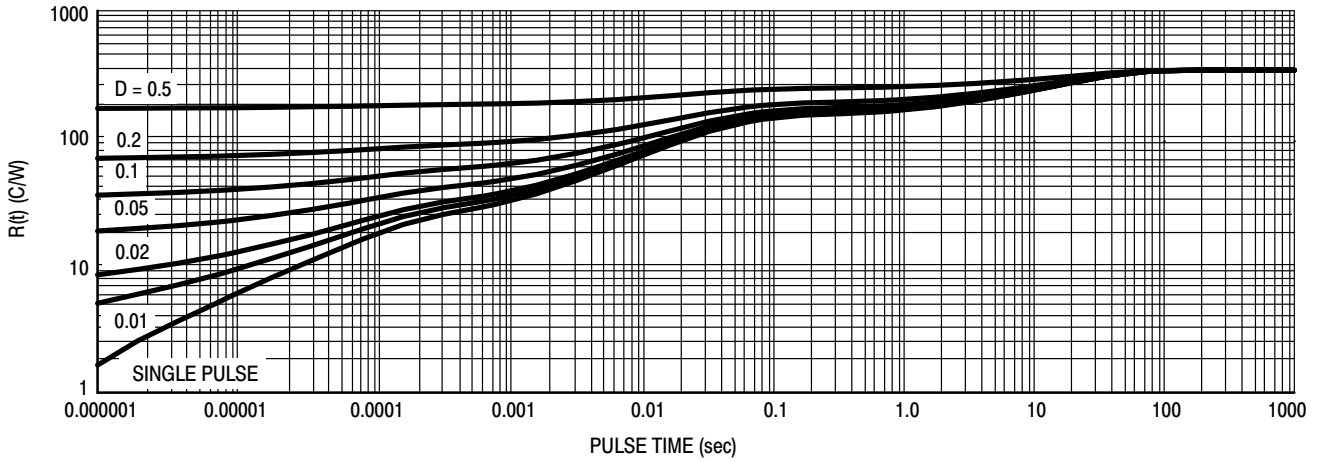

Figure 1. Thermal Response (Note 1)

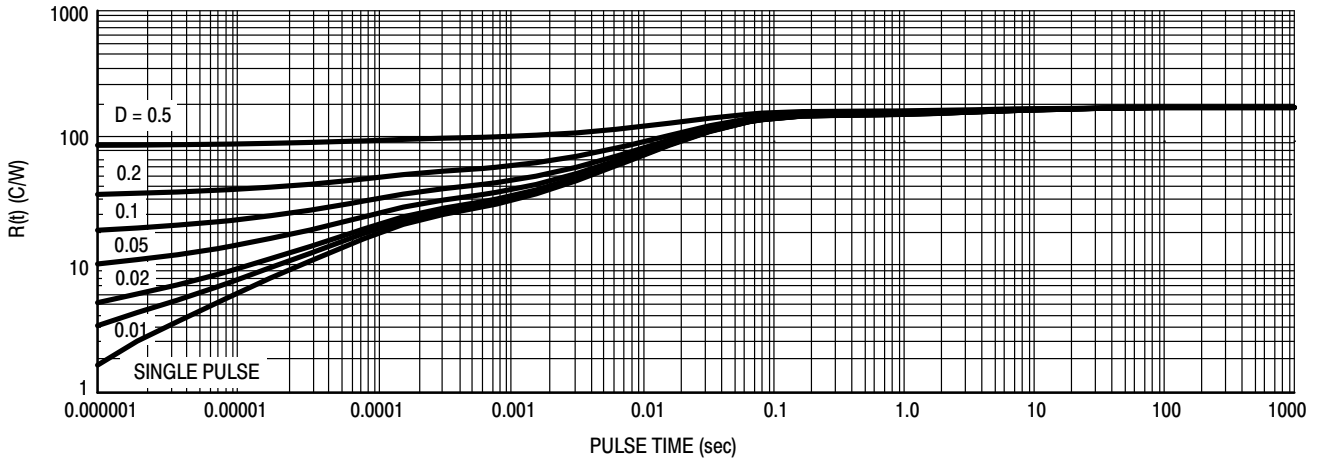

Figure 2. Thermal Response (Note 2)

NSR05T40P2

ELECTRICAL CHARACTERISTICS ($T_A = 25^\circ\text{C}$ unless otherwise noted)

| Characteristic | Symbol | Min | Typ | Max | Unit |
|------------------------------------------------------------------------------------------------------------------------------------|-----------|-----|--------------------------|--------------------------|---------------|
| Reverse Leakage ($V_R = 10\text{ V}$) ($V_R = 40\text{ V}$) | I_R | | 0.2 2.0 | 5.0 55 | μA |
| Forward Voltage ($I_F = 10\text{ mA}$) ($I_F = 100\text{ mA}$) ($I_F = 200\text{ mA}$) ($I_F = 500\text{ mA}$) | V_F | | 360 450 490 580 | 410 500 550 700 | mV |
| Total Capacitance ($V_R = 1.0\text{ V}$, $f = 1.0\text{ MHz}$) | C_T | | 29 | | pF |
| Reverse Recovery Time ($I_F = I_R = 10\text{ mA}$, $I_{R(\text{REC})} = 1.0\text{ mA}$, Figure 3) | t_{rr} | | 8.0 | | ns |
| Peak Forward Recovery Voltage ($I_F = 100\text{ mA}$, $t_r = 20\text{ ns}$, Figure 4) | V_{FRM} | | 560 | | mV |

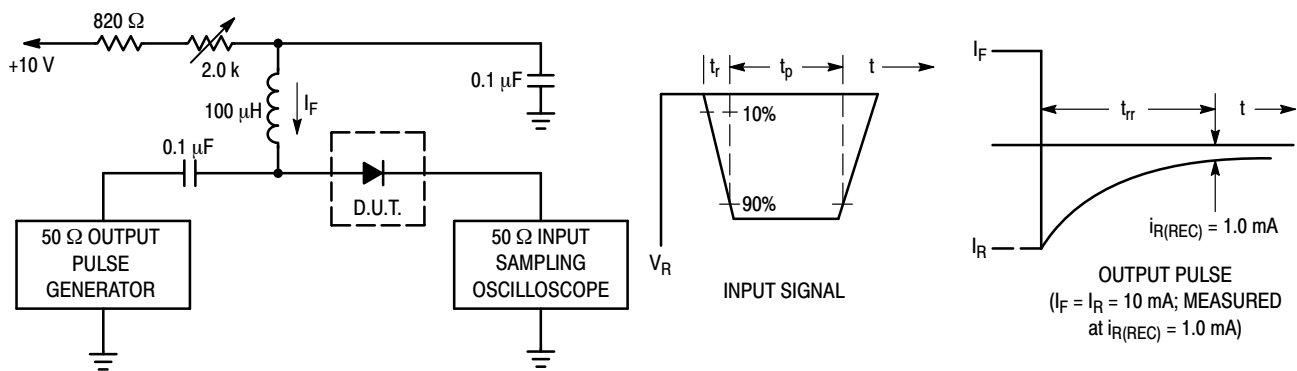

Figure 3. Recovery Time Equivalent Test Circuit

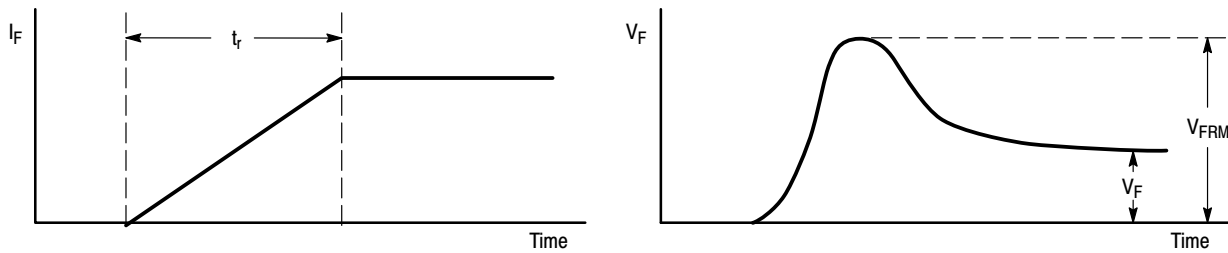

Figure 4. Peak Forward Recovery Voltage Definition

NSR05T40P2

TYPICAL CHARACTERISTICS

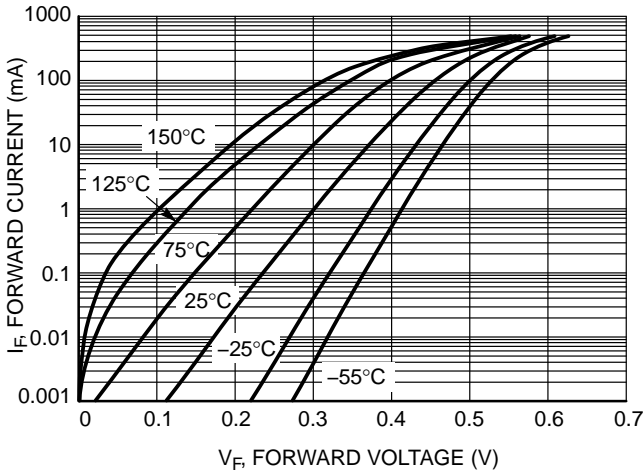

Figure 5. Forward Voltage

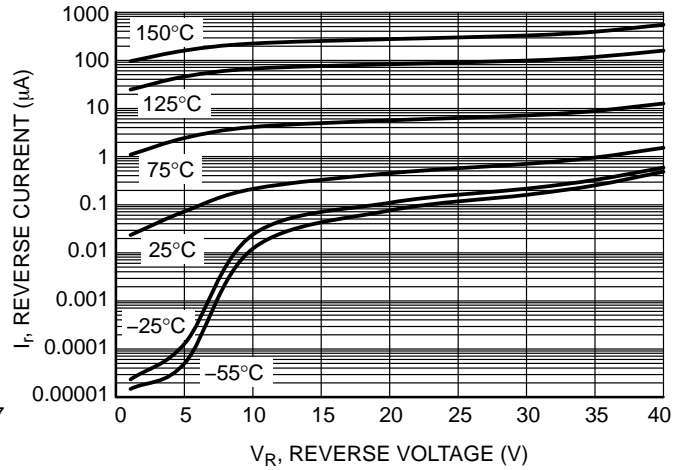

Figure 6. Leakage Current

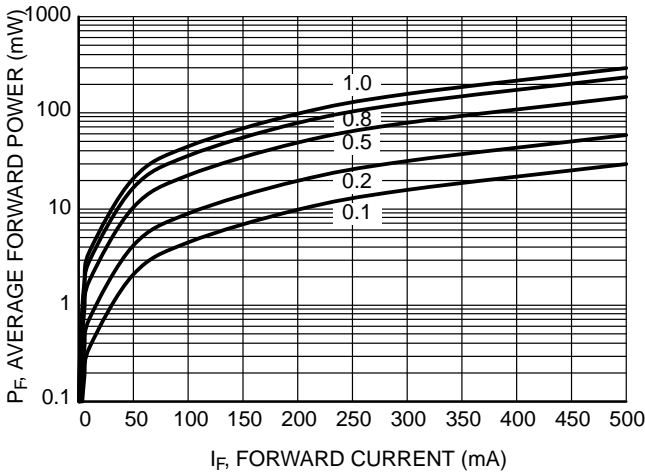

Figure 7. Average Forward Power Dissipation

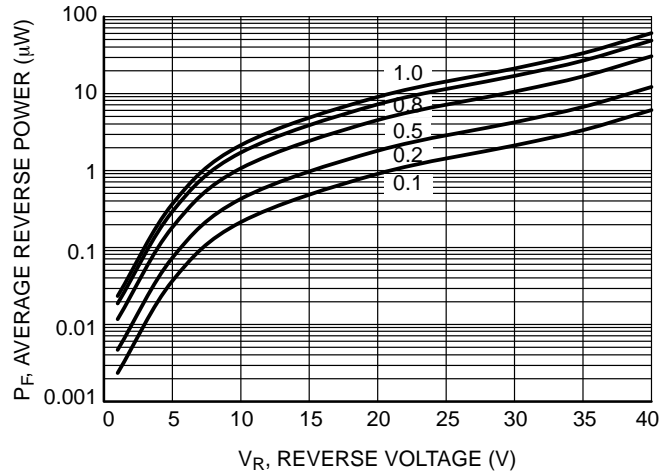

Figure 8. Average Reverse Power Dissipation

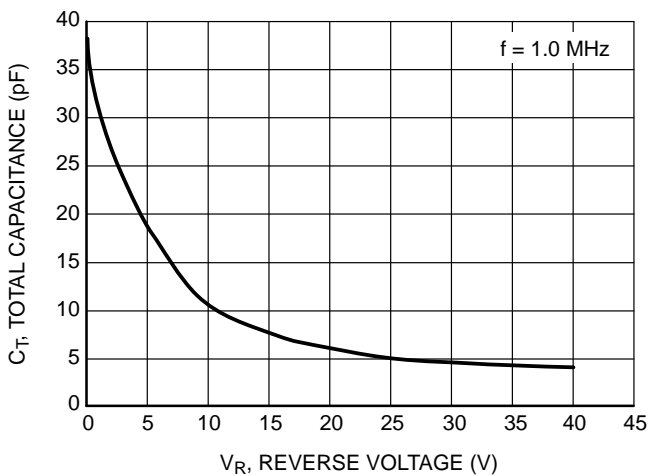

Figure 9. Total Capacitance

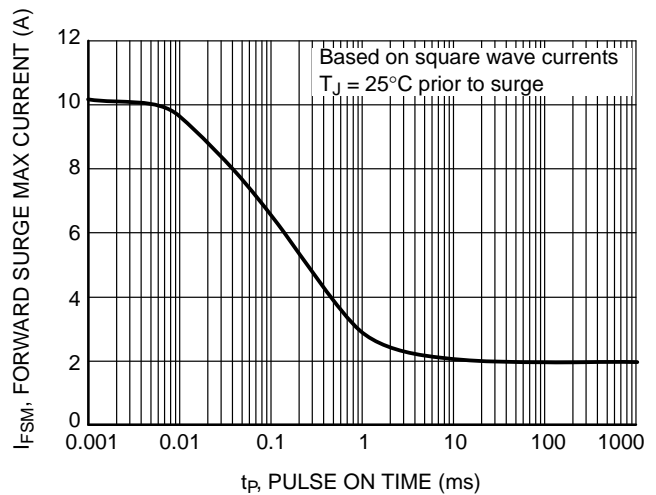
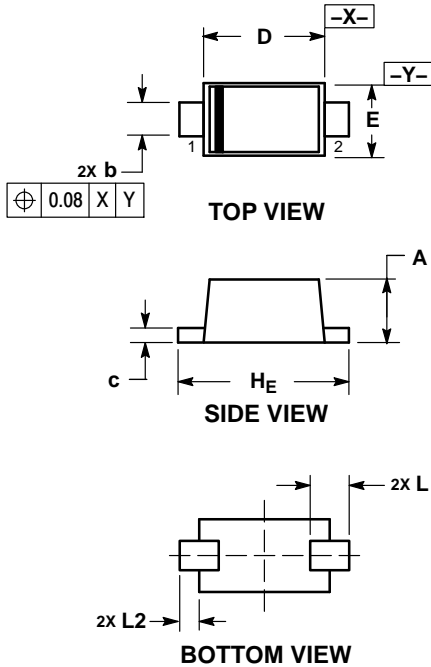

Figure 10. Forward Surge Current

NSR05T40P2

PACKAGE DIMENSIONS

SOD-923
CASE 514AA
ISSUE E



NOTES:

1. DIMENSIONING AND TOLERANCING PER ASME Y14.5M, 1994.
2. CONTROLLING DIMENSION: MILLIMETERS.
3. MAXIMUM LEAD THICKNESS INCLUDES LEAD FINISH. MINIMUM LEAD THICKNESS IS THE MINIMUM THICKNESS OF BASE MATERIAL.
4. DIMENSIONS D AND E DO NOT INCLUDE MOLD FLASH, PROTRUSIONS, OR GATE BURRS.

| DIM | MILLIMETERS | | | INCHES | | |
|----------------|-------------|------|------|-----------|-------|-------|
| | MIN | NOM | MAX | MIN | NOM | MAX |
| A | 0.34 | 0.39 | 0.43 | 0.013 | 0.015 | 0.017 |
| b | 0.15 | 0.20 | 0.25 | 0.006 | 0.008 | 0.010 |
| c | 0.07 | 0.12 | 0.17 | 0.003 | 0.005 | 0.007 |
| D | 0.75 | 0.80 | 0.85 | 0.030 | 0.031 | 0.033 |
| E | 0.55 | 0.60 | 0.65 | 0.022 | 0.024 | 0.026 |
| H _E | 0.95 | 1.00 | 1.05 | 0.037 | 0.039 | 0.041 |
| L | 0.19 REF | | | 0.007 REF | | |
| L2 | 0.05 | 0.10 | 0.15 | 0.002 | 0.004 | 0.006 |

SOLDERING FOOTPRINT*

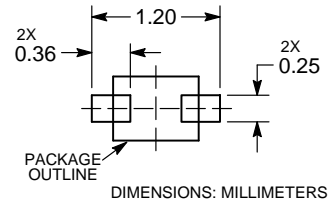

See Application Note AND845/D for more mounting details

*For additional information on our Pb-Free strategy and soldering details, please download the ON Semiconductor Soldering and Mounting Techniques Reference Manual, SOLDERRM/D.

ON Semiconductor and the are registered trademarks of Semiconductor Components Industries, LLC (SCILLC) or its subsidiaries in the United States and/or other countries. SCILLC owns the rights to a number of patents, trademarks, copyrights, trade secrets, and other intellectual property. A listing of SCILLC's product/patent coverage may be accessed at www.onsemi.com/site/pdf/Patent-Marking.pdf. SCILLC reserves the right to make changes without further notice to any products herein. SCILLC makes no warranty, representation or guarantee regarding the suitability of its products for any particular purpose, nor does SCILLC assume any liability arising out of the application or use of any product or circuit, and specifically disclaims any and all liability, including without limitation special, consequential or incidental damages. "Typical" parameters which may be provided in SCILLC data sheets and/or specifications can and do vary in different applications and actual performance may vary over time. All operating parameters, including "Typicals" must be validated for each customer application by customer's technical experts. SCILLC does not convey any license under its patent rights nor the rights of others. SCILLC products are not designed, intended, or authorized for use as components in systems intended for surgical implant into the body, or other applications intended to support or sustain life, or for any other application in which the failure of the SCILLC product could create a situation where personal injury or death may occur. Should Buyer purchase or use SCILLC products for any such unintended or unauthorized application, Buyer shall indemnify and hold SCILLC and its officers, employees, subsidiaries, affiliates, and distributors harmless against all claims, costs, damages, and expenses, and reasonable attorney fees arising out of, directly or indirectly, any claim of personal injury or death associated with such unintended or unauthorized use, even if such claim alleges that SCILLC was negligent regarding the design or manufacture of the part. SCILLC is an Equal Opportunity/Affirmative Action Employer. This literature is subject to all applicable copyright laws and is not for resale in any manner.

PUBLICATION ORDERING INFORMATION

LITERATURE FULFILLMENT:
Literature Distribution Center for ON Semiconductor
P.O. Box 5163, Denver, Colorado 80217 USA
Phone: 303-675-2175 or 800-344-3860 Toll Free USA/Canada
Fax: 303-675-2176 or 800-344-3867 Toll Free USA/Canada
Email: orderlit@onsemi.com

N. American Technical Support: 800-282-9855 Toll Free USA/Canada
Europe, Middle East and Africa Technical Support:
Phone: 421 33 790 2910
Japan Customer Focus Center
Phone: 81-3-5817-1050

ON Semiconductor Website: www.onsemi.com
Order Literature: <http://www.onsemi.com/orderlit>
For additional information, please contact your local Sales Representative