



## ***IIC Bus Controlled On-Screen Display***

### **Features**

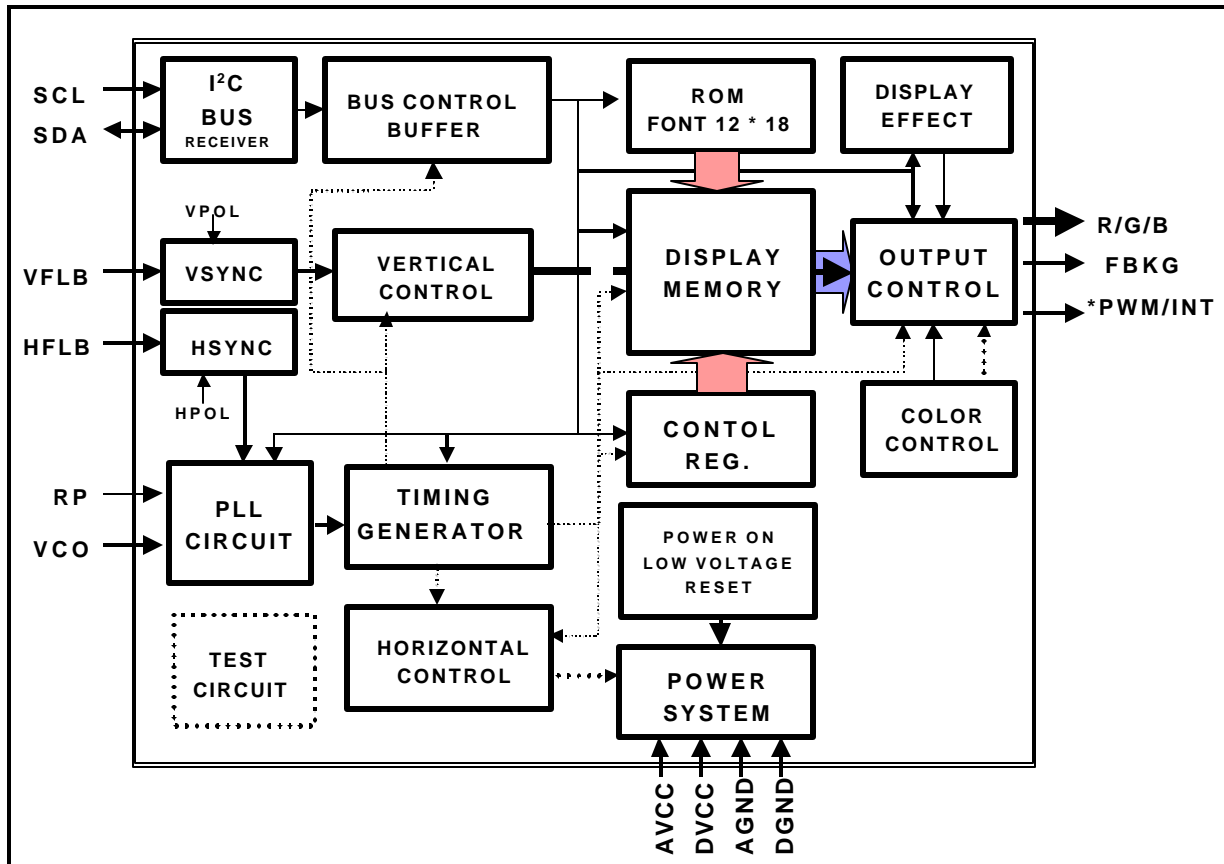
- IIC Bus Interface with Slave Address \$7A (Transmitter) & \$7B (Receiver)
- Horizontal Frequency Range: 30KHz ~ 150KHz\*
- Flexible Display Resolution Up to 1524 Dots/Row
- Internal PLL Generates a Stable and Wide-Ranged System Clock (120 MHz)\*
- OSD Screen Consist Character Array of 15 Rows by 30 Columns
- Programmable Vertical and Horizontal Position for OSD Displaying Center
- Total of 528\* ROM Fonts including 512\* Standard & 16 Multi-color ROM Fonts.
- 12 X 18 Dot Matrix Per Character
- 8-Color Selection for Each Character
- 7-Color Selection for Each Character Background
- Character/Symbol Blinking, Shadowing & Bordering Display Effect
- Double Character Height and Width for Each Row
- Programmable Height of Character/Symbol Display
- Row To Row Spacing Control to Avoid Expansion Distortion
- Four Programmable Windows with Overlapping Capability and Shadowing Effect
- Color Setting for Windows' Background and Character Shadowing & Bordering
- Fade-In/Out Effect of OSD Screen Display
- Hsync & Vsync Input Polarity Selectable

### **General Description**

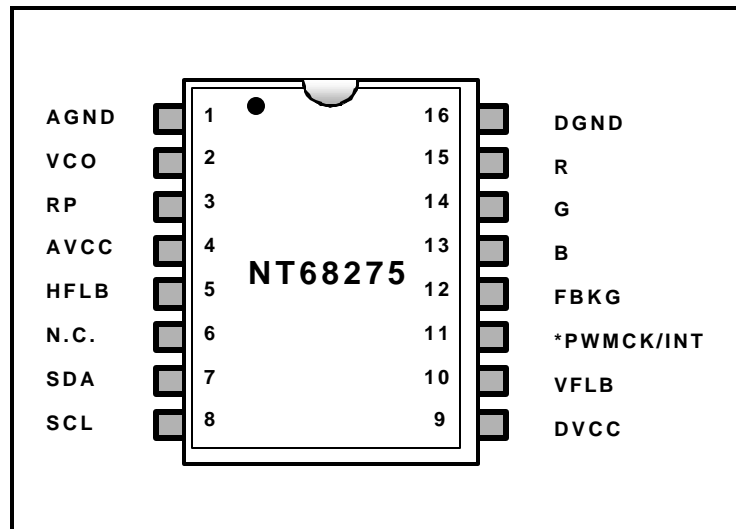
NT68275 is designed for displaying symbols and characters onto a CRT monitor. Its operation is controlled by a microcontroller with an IIC bus interface. By sending proper data and commands to NT68275, it can carry out the full screen display automatically with the time base generated by an on-chip PLL circuit. There are many functions provided by this chip to fully support user applications, such as: adjustment of the position of OSD

windows, built-in 512\* ROM & 16 multi-color fonts, variable character height with row-to-row spacing adjustment, 8 color selections & 7 background color controls for each character, double height/width controls for each row, 4 overlapping window available with color & size controls, size controls for each window shadowing, color selection for windows' shadowing & character shadowing/ bordering, fade-in/out display effect, etc.

The “ \* ” sign denotes that feature different from NT6827.

**Block Diagram**


---

**Pin Assignment**

**Pin Description**

<b>NT68275</b>	<b>NAME</b>	<b>I/O/P/R</b>	<b>Function</b>
<b>1</b>	AGND	P	Analog Ground
<b>2</b>	VCO	-	Voltage I/P to Control Oscillator
<b>3</b>	RP	-	Bias Resistor. Used to bias internal VCO to resonate at specific dot frequency
<b>4</b>	AVCC	P	Analog Power Supply (5 V Typ.)
<b>5</b>	HFLB	I	Horizontal Fly-back Input (Schmitt Trigger Buffer)
<b>6</b>	N.C.	-	-
<b>7</b>	SDA	I	SDA Pin Of IIC Bus (Schmitt Trigger Buffer) with internal 100K ohm pulled-high resistance
<b>8</b>	SCL	I	SCL Pin Of IIC Bus (Schmitt Trigger Buffer) with internal 100K ohm pulled-high resistance
<b>9</b>	DVCC	P	Digital Power Supply (5 V Typ.)
<b>10</b>	VFLB	I	Vertical Fly-back Input (Schmitt Trigger Buffer)
<b>11</b>	*PWMC K/INT	O	PWM output or Intensity output
<b>12</b>	FBKG	O	Fast Blanking Output. Used to cut off external R, G, B signals.
<b>13</b>	B	O	Blue Color Output with Push-Pull Output Structure
<b>14</b>	G	O	Green Color Output with Push-Pull Output Structure
<b>15</b>	R	O	Red Color Output with Push-Pull Output Structure
<b>16</b>	DGND	P	Digital Ground

**DC/AC Absolute Maximum Ratings\***
**Recommended Operating Conditions**

VCC (measured to GND) . . . . . 4.75V to 5.25V

Operating Temperature . . . . . 0 to +70 0C

**\*Comments**

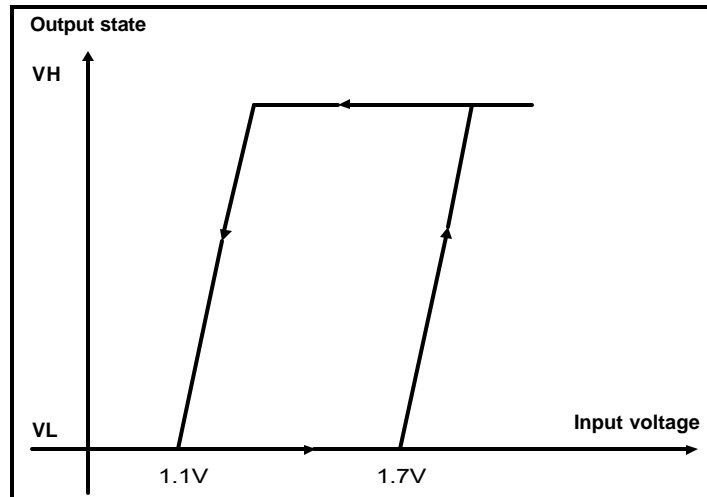
Stresses above those listed under "Absolute Maximum Ratings" may cause permanent damage to this device. These are stress ratings only. Functional operation of this device at these or any other conditions above those indicated in the operational sections of this specification is not implied or intended. Exposed to the absolute maximum rating conditions for extended periods may affect device reliability.

**Electrical Characteristics (VDD = 5V, Tamb = 25° C)**

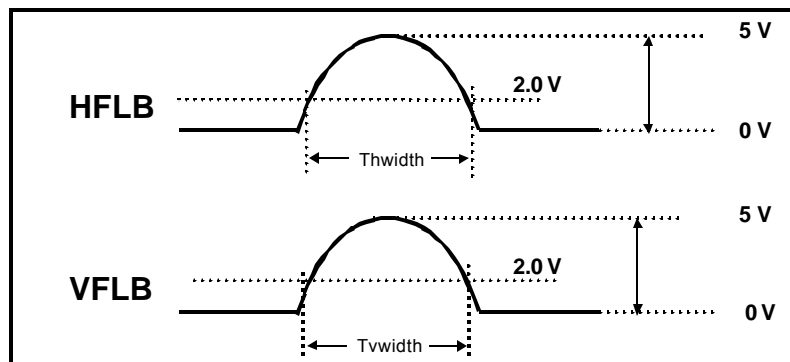
Symbol	Parameter	Min.	Typ.	Max.	Unit	Notes
VCC	Supply Voltage	4.75	5	5.25	V	

**DC Characteristic**

Symbol	Parameter	Min.	Typ.	Max.	Unit	Notes
I <sub>DD</sub>	Operating Current		22	25	mA	No loading
V <sub>IH1</sub>	Input High Voltage	2			V	VFLB, HFLB with Schmitt Trigger Buffer
V <sub>IL1</sub>	Input Low Voltage			0.8	V	VFLB, HFLB Schmitt Trigger Buffer
V <sub>IH2</sub>	IIC Bus Input High Voltage	3			V	SCL, SDA
V <sub>IL2</sub>	IIC Bus Input Low Voltage			1.5	V	
I <sub>drive1</sub>	Driving current of R, G, B, FBKG, HFTON output pins at 2.4V output voltage	80			mA	
I <sub>sink1</sub>	Sinking current of R, G, B, FBKG, HFTON output pins at 0.4V output voltage	20			mA	
I <sub>leak</sub>	Leakage current of R, G, B, FBKG pins at Hi-Z state			10	uA	Measured at 2.5V state
I <sub>iicl</sub>	IIC Bus Output Sink Current		5		mA	V <sub>iicoutl</sub> = 0.4V
V <sub>th</sub>	Input Threshold Voltage at HFLB & VFLB	1.8	2.0	2.2	V	
V <sub>STIH</sub>	Schmitt Trigger Input High Voltage		1.7	2	V	Refer Figure 1
V <sub>STIL</sub>	Schmitt Trigger Input Low Voltage	0.8	1.1		V	
I <sub>in</sub>	Input Current of Hsync, Vsync, SDA, SCL pins	-10		+10	uA	Schmitt Trigger Buffer


**Figure 1. Schmitt Trigger Diagram**
**AC Characteristic**

Symbol	Parameter	Min.	Typ.	Max.	Unit	Notes
Fhfy	Horizontal Fly-back Frequency	30		*150	KHz	
Vhfly	Horizontal Fly-back Input			5	V	
		0			V	
Thflymin	Minimum Pulse Width of Horizontal Fly-back	0.7			us	
Thflymax	Maximum Pulse Width of Horizontal Fly-back			5.5	us	
Fvfy	Vertical Fly-back Frequency	50		*200	Hz	
Vvfly	Vertical Fly-back Input			5	V	
		0			V	
Tvflymin	Minimum Pulse Width of Vertical Fly-back	20			us	
Tvflymax	Maximum Pulse Width of Vertical Fly-back			1	ms	


**Figure 2. HV Fly-Back Signal**

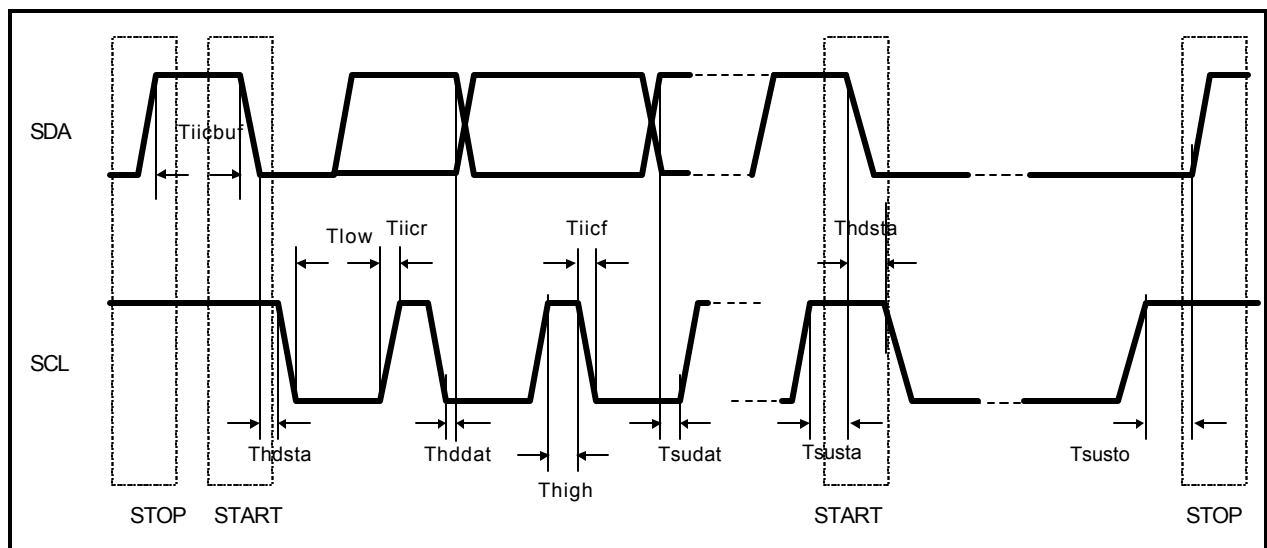


**IIC Bus - Slave Transmitter & Receiver (Slave address: \$7A & \$7B)**

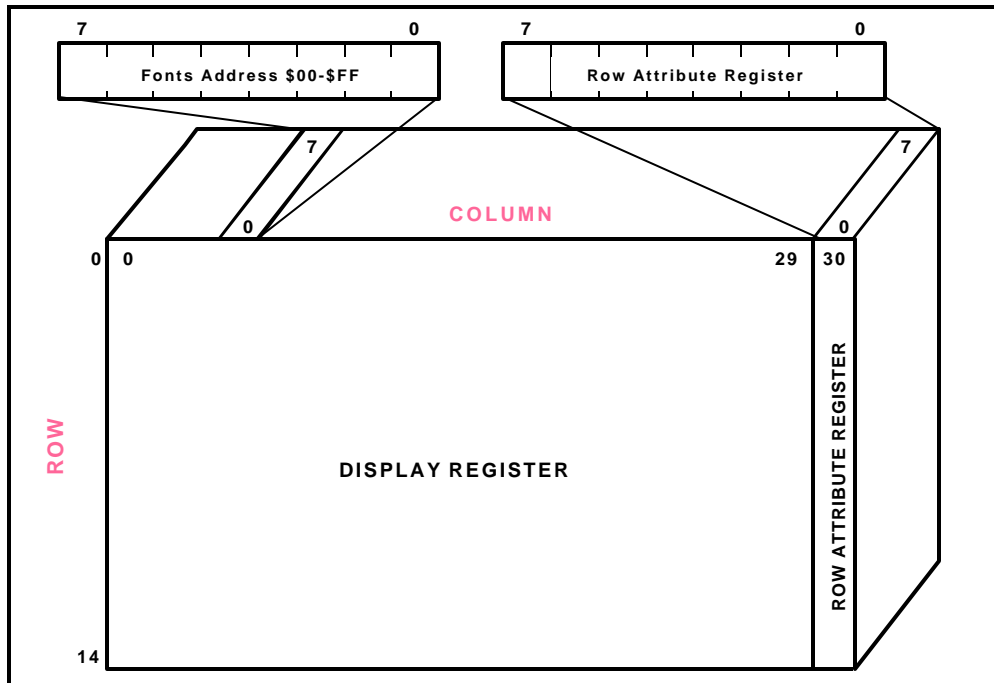
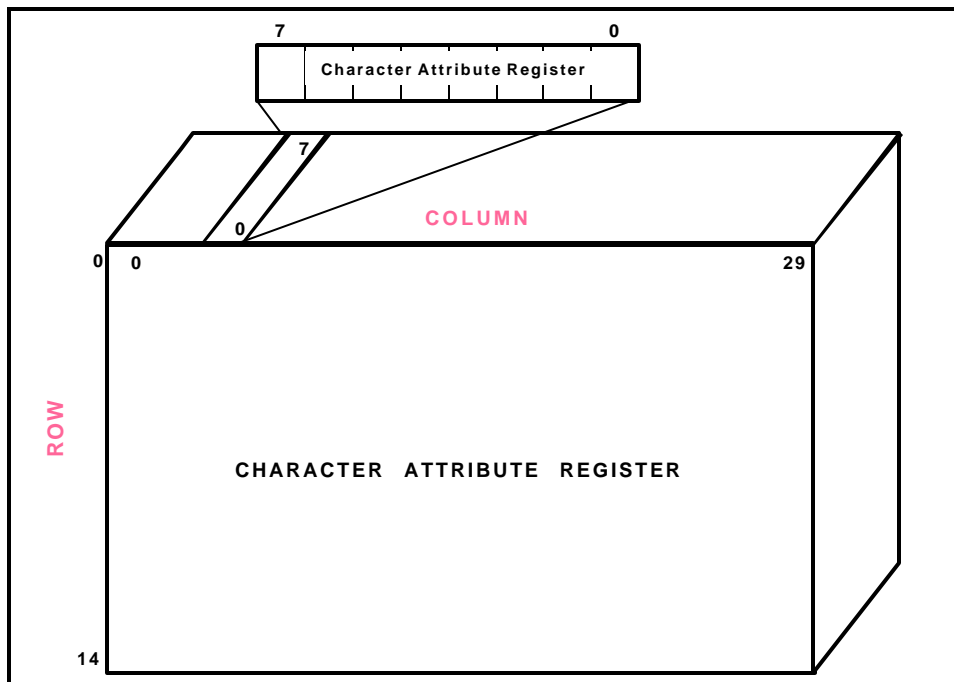
Table 1. IIC Bus

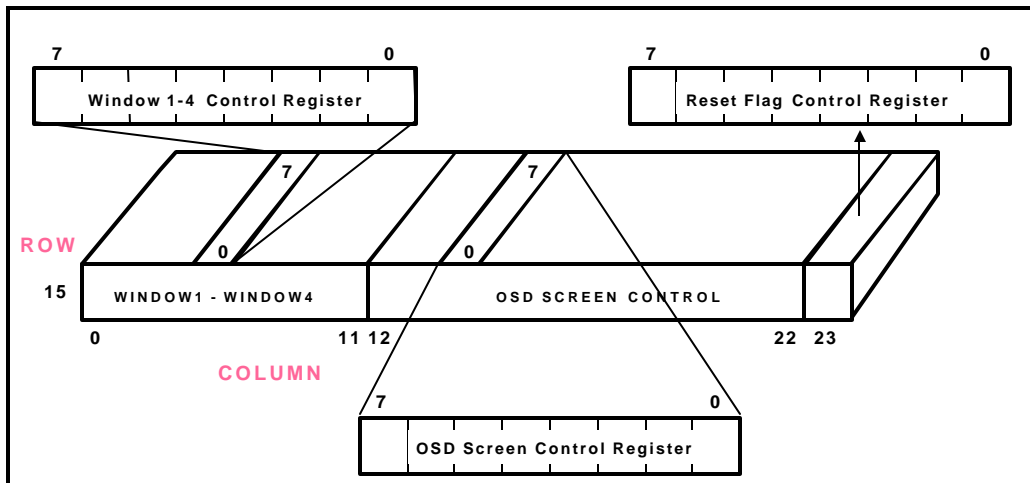
Symbol	Parameter	Min.	Typ.	Max.	Unit	Notes	
Fmaxcl	Maximum SCL Clock Frequency			100	KHz		
VIL	Input Low Voltage	-0.5		1.5	V		
VIH	Input High Voltage	3.0		5.5	V		
Tlow	Low Period of SCL Clock	4.7			us	SCL, SDA	
Thigh	High Period of SCL Clock	4.0			us		
Tsudat	Data Setup Time	250			ns		
Thddat	Data Hold Time	300			ns		
Tiicr	Rise Time of IIC Bus			1000	ns		
Tiicf	Fall Time of IIC Bus			300	ns		
Tsusta	Setup Time for Repeated START Condition	1.3			us		
Thdsta	Hold Time for START Condition	4.0			us		
Tsusta	Setup Time for START Condition	4.7			us		
Tsusto	Setup Time for STOP Condition	4.0			us		
Tiicbuf	Time IIC bus must be free before next new transmission can start	4.7			us		
Iiicl	IIC Bus Sink Current	4	5		mA		Viicoutl = 0.4 V
Tfilter	Input Filter Spike Suppression			100	ns		SCL, SDA

See also IIC Table Control and IIC Sub Address Control

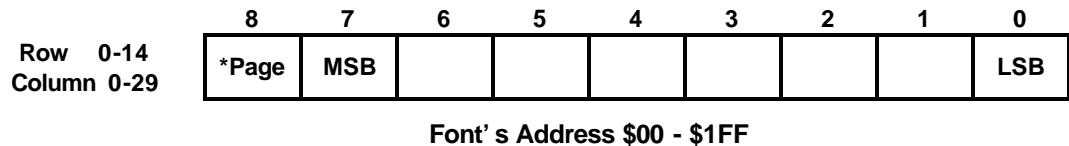

**Figure 3. IIC Bus Timing**



**Memory Map**

**Figure 4-1. Memory Map of Display Register (Row 0–14)**

**Figure 4-2. Memory Map of Attribute Register (Row 0–14)**

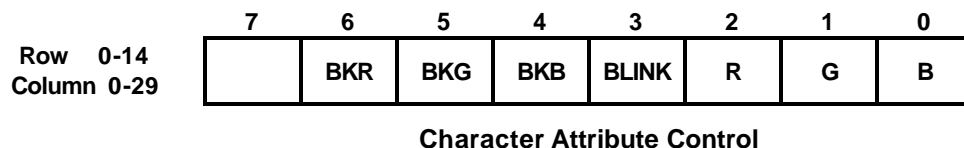


**Figure 4-3. Memory Map of Control Register (Row 15)**

**List of Control Registers:**
**(1) Display Register: Row 0 –14 , Column 0 –29**


**Bit 8: \* Page** - This bit will address the page 1 ROM font area by bit 7-0 of this control register. Otherwise, it will address page 0. This can be set by the bit5 column data at IIC bus transmission. Refer to Figure 8-1 & 8-3 for ROM font area.

**Bit 7-0:** These eight bits will address one of the 256 characters/ symbols residing in the character ROM fonts. Note that if user sets MCFONT bit (row 15, column 22) to '1', the 0 ~ 256 will address standard ROM fonts, and if cleared to '0', the 0 ~ 239 will address standard ROM fonts & 240 ~ 255, multi-color ROM fonts.

**(2) Character Attribute Register: Row 0 –14, Column 0 –29**


**Bit 6-4: BKR/G/B** -These three bits define the color attribute of the background for the corresponding character/symbol. If all three bits are cleared, no background will be displayed. Refer to the TAB 3 for the color selections.

**Bit 3: BLINK** - This bit enables the blinking effect of the corresponding character/symbol with this bit set to '1'. The blinking frequency is approximately 1Hz with a fifty-fifty duty cycle at 80Hz vertical sync frequency.

**Bit 2-0: R/G/B** -These three bits define the color attribute of the corresponding character/symbol. Refer to the TAB 2 for the color selections.

**TAB 2. Character/Window Color Selection**

COLOR	R	G	B
Black	0	0	0
Blue	0	0	1
Green	0	1	0
Cyan	0	1	1
Red	1	0	0
Magenta	1	0	1
Yellow	1	1	0
White	1	1	1

**TAB 3. Character/Window Background Color Selection**

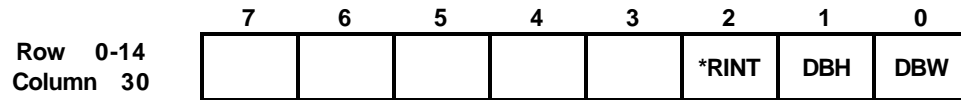
COLOR	R	G	B
No Background	0	0	0
Blue	0	0	1
Green	0	1	0
Cyan	0	1	1
Red	1	0	0
Magenta	1	0	1
Yellow	1	1	0
White	1	1	1



**NT68275**

***IIC Bus Controlled On-Screen Display***

---

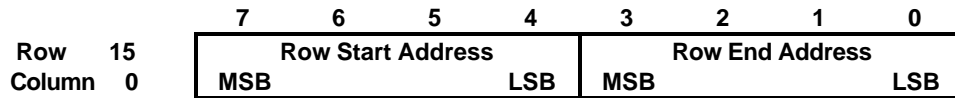
**(3) Row Attribute Register: Row 0 – 14, Column 30**


**Row' s Attribute Control**

**Bit 1: DBH** – This bit controls the height of the displayed character/symbol. When this bit is set, the character/symbol is displayed in double height.

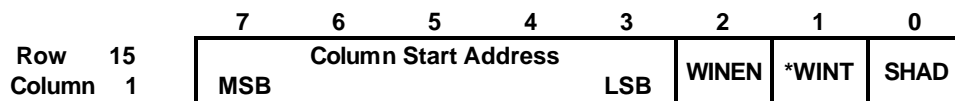
**Bit 0: DBW** – This bit controls the width of the displayed character/symbol. When this bit is set, the character/symbol is displayed in double width.

**Bit 2: \* RINT** – Row intensity, This bit controls the intensity of the corresponding row .By setting this bit to 1, the INT pin will go high when the characters of this row are displayed. See Figure 5.

**(4) Window 1 Registers: Row 15, Column 0**

**Window 1 Row Size Control**

**Bit 7-4:** These bits determine the row start position of Window 1 on the 15\*30 OSD screen.

**Bit 3-0:** These bits determine the row end position of Window 1 on the 15\*30 OSD screen.

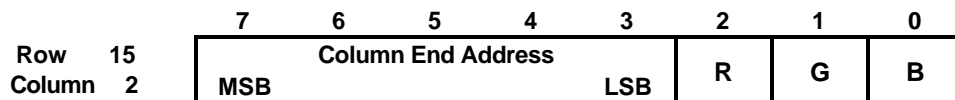

**Window1 Column Size Control & Attribute Control**

**Bit 7-3:** These bits determine the column start position of Window 1 on the 15\*30 OSD screen.

**Bit 2: WINEN** - This bit enables window 1 when it is set. The default value is 0 after power on.

**Bit 1: \* WINT** - Window intensity. This bit controls the intensity of Window 1 .By setting this bit to 1, the INT pin will go high while displaying Window 1 and characters inside the window. See Figure 5.

**Bit 0: SHAD** - This bit enables the shadowing on the window when it is set to '1'. The default value is 0 after power on.


**Window 1 Column Size Control & Attribute Control**

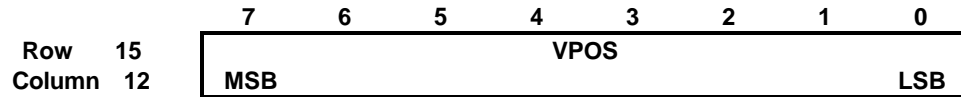
**Bit 7-3:** These bits determine the column end position of Window 1 on the 15\*30 OSD screen.

**Bit 2-0: R/G/B** – These bits control the background color of Window 1. Refer to Table for color selection.

**Note:** Window 1 control registers occupy column 0-2 of row 15, Window 2 from column 3-5, Window 3 from 6-8 and Window 4 from 9-11. The function of Window 2- 4 control registers is the same as Window 1. Window 1 has the highest priority, and the Window 4, the least. The higher priority color will take over on the overlap window area.

If the start address of the row/column is greater than the end address, the window will not be displayed.

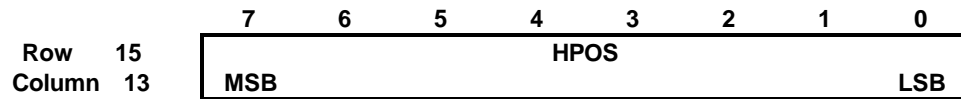
Out of range setting (over 15 rows or 30 columns range) will cause abnormal operation.

**OSD Screen Position Control Registers: Row 15, Column 12 - 13**

**Vertical Position Adjustment**

**Bit 7-0: VPOS** - These bits determine the vertical starting position for the character display. It is the vertical delay starting from the leading edge of VFLB. The unit of this setting is 4 horizontal lines and the equation is defined as below:

$$\text{Vertical delay} = (\text{Vpos} * 4 + 1) * \text{Horizontal line}$$

. The default value of it is 4 (\$04) after power on.


**Horizontal Position Adjustment**

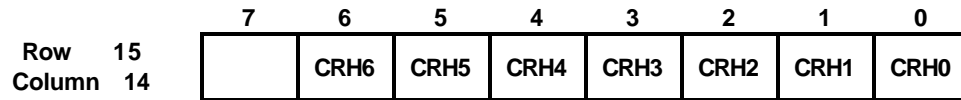
**Bit 7-0: HPOS** – These bits determine the horizontal starting position for the character display. It is the horizontal delay starting from the leading edge of HFLB. The unit of this setting is 6 dots movement shift to right on the monitor screen and the equation is defined as below:

$$\text{Horizontal delay} = (\text{Hpos} * 6 + 49) / \text{P.R.}$$

where the P.R. (pixel rate) is defined by the HDR & Horizontal Frequency.

$$\text{P.R. (Pixel Rate)} = \text{HDR} * 12 * \text{Freq}_{\text{HFLB}}$$

Refer the HDR control register at row 15 / column 15 for the P.R. setting.  
The default value of these bit is 15 (\$ 0F) after power on.

**(5) Character Height Control: Row 15, Column 14**

**Character's Height Control**

**Bit 6-0: CRH6-CRH0** - These bits determine the displayed character height. Character, original 12 by 18 font matrix, can be expanded from 18 to 71 lines. Refer to the table below. All of these bits will be cleared to '0' after power on.

If the setting value of CH0 – CH6 is great than 17, the algorithm will repeat at most 17 lines.

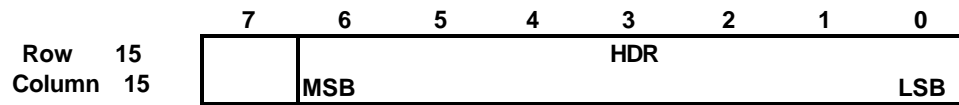
**TAB 4. Lines Expanded Control**

CRH6 ~ CRH0	Lines Inserted
CRH6 = '1', CRH5 = '1'	All 18 lines repeat twice
CRH6 = '1', CRH5 = '0'	All 18 lines repeat once
CRH6 = '0', CRH5 = 'X'	Repeat at most 17 lines
CRH4 = '1'	Insert 16 lines
CRH3 = '1'	Insert 8 lines
CRH2 = '1'	Insert 4 lines
CRH1 = '1'	Insert 2 lines
CRH0 = '1'	Insert 1 lines

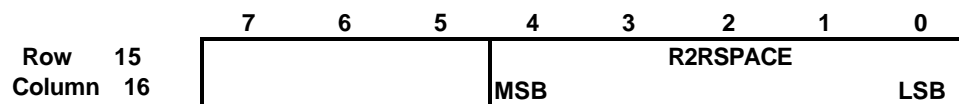
**TAB 5. Lines Expanded Position**

No. of Lines Inserted	Repeat Position																	
	1	2	3	4	5	6	7	8	9	10	11	12	13	14	15	16	17	18
Insert 1 lines								!										
Insert 2 lines					!							!						
Insert 4 lines			!				!				!				!			
Insert 8 lines		!		!		!		!		!		!		!		!		
Insert 16 lines		!	!	!	!	!	!	!	!	!	!	!	!	!	!	!	!	!
Insert 17 lines	!	!	!	!	!	!	!	!	!	!	!	!	!	!	!	!	!	!

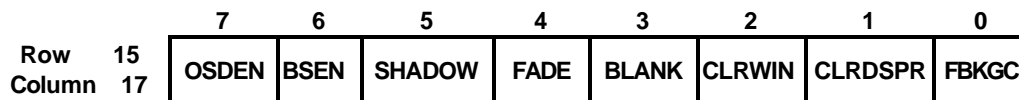


**(6) Flexible Display Control Register : Row 15 , Column 15**

**Horizontal Display Resolution Control**

**Bit 6-0: HDR** -These bits determine the resolution of the horizontal display line. The unit of this setting is twelve dots (one character). With total 92 steps (\$24 ~ \$7F: 36 ~ 127 steps; value cannot be smaller than 36 anytime.), user can adjust the resolution from 36 to 127 characters on each horizontal line. Note that the resolution adjustment must cooperate with the VCO setting at row 15 / column 18 control register. Refer to the table of the control register at row 15 / column 18. The default value of it is 40 after power on.

**(7) OSD Row to Row Space Control Register : Row 15 , Column 16**

**Row To Row Space Adjustment**

**Bit 4-0: R2RSPACE** - These bits define the row-to-row spacing in units of horizontal lines. Extra lines defined by this 5-bit value will be appended for each display row. The default value is 0 after power on and there is no extra line inserted between rows. All of these bits will be cleared to '0' after power on.

**(8) Input/Output Control Register : Row 15 , Column 17**

**OSD Screen Control 1**

**Bit 7: OSDEN** – This bit will enable the OSD circuit when it is set to '1'. The default value is '0' after power on.

**Bit 6: BSEN** – This bit will enable the bordering and shadowing effect when it is set to '1'. The default value is '0' after power on.

**Bit 5: SHADOW** – When the BSEN set to '1', it will enable the shadowing effect when this bit set to '1', too. Otherwise, it will enable the bordering effect as this bit is cleared to '0'. The default value is '0' after power on.

**Bit 4: FADE** - This bit enables the fade-in/out effect when the OSD screen is turned on by setting from OSDEN = '0' to '1' or turned off by setting from OSDEN = '1' to '0'. The fade-in/out effect will be completed about 0.5 seconds when the input Vsync is 60 Hz. The default value of this bit is '0' after power on.

**Bit 3: BLANK** – This bit will force the FBKG pin to output high when this bit & the FBKGOP are bit set to '1'. Otherwise, the FBKG pin will output low when this bit is set to '1' & FBKGOP bit set to '0'. The default value of this bit is '0' after power on.

**Bit 2: CLRWIN** – This bit will clear all windows' WINEN control bit as it is set to '1'. The default value of this bit is '0' after power on.

**Bit 1: CLRDSPR** – This bit will clear all of the content in the display registers and R, G, G, BLNK bit in the character attribute registers when it is set to '1'. The default value of this bit is '0' after power on.

---

**Bit 0: FBKGC** - It determines the configuration of FBKG output pin. When it is cleared, the FBKG pin will output high during displaying characters or windows. Otherwise, it will output high only during displaying characters. The default value of this bit is '0' after power on.

		7	6	5	4	3	2	1	0
Row 15	Column 18	RGBF	FBKGOP	*PWM/INT	DBOUNCE	HPOL	VPOL	VCO1	VCO0

### OSD Screen Control 2

- Bit 7: RGBF** - This bit controls the driving state of output pins, R, G, B and FBKG when the OSD is disabled. After power on, this bit is cleared to '0' and all of the R, G, B and FBKG pins output a high impedance state while the OSD is being disabled. If this bit is set to '1', the R, G, B output pins will drive low, FBKG pin drive high or low depend on FBKGOP (If FBKGOP=0, drive high. If FBKGOP=1, drive low) while OSD being disabled.
- Bit 6: FBKGOP** - This bit selects the polarity of the output signal of FBKG pin. This signal is active low when the user clears this bit. Otherwise, active high set this bit. Refer the figure 5 below for the FBKG output timing. The default value is '1' after power on.
- Bit 5: \* PWM/INT** - This bit selects the output option to PWM/INT pin. This bit will enable the PWM clock output as it is set to '1'. Otherwise, it will select the INT option. Refer the figure 5 below for the INT output timing. The default value is '0' after power on.
- Bit 4: DBOUNCE** - This bit is to activate the debounce circuit of horizontal and vertical scan. It is to prevent from the OSD screen shaking when user adjusts the horizontal phase or vertical position. This bit will be cleared after power on.
- Bit 3: HPOL** - This bit selects the polarity of the input signal of horizontal sync (HFLB pin). If the input sync signal is negative polarity, user must clear this bit. Otherwise, set this bit to '1' to accept the positive polarity signal. After power on, this bit is cleared to '0' and it will accept negative polarity sync signal.
- Bit 2: VPOL** - This bit selects the polarity of the input signal of vertical sync (VFLB pin). If the input sync signal is negative polarity, user must clear this bit. Otherwise, set this bit to '1' to accept the positive polarity signal. After power on, this bit is cleared to '0' and it will accept negative polarity sync signal.
- Bit 1-0: VCO1/0** – These bits select the VCO frequency range when user set the horizontal display resolution flexibly. It is related to the horizontal display resolution and user must set the control register at row15 / column15 properly. The default value is VCO1=0 & VCO0=0 after power on state. The relationship between VCO1/0 and display resolution is list below:

**TAB 6. P.R. (Pixel Rate) = HDR \* 12 \* Freq<sub>HFLB</sub>**

Section	VCO1	VCO0	VCO Freq. Min	VCO Freq. Max	Unit	P.R. Limit	HFLB Freq. Limit
Freq1	0	0	*6	*13	MHz	Min < P.R. < Max	$(\text{Min} / \text{HDR} * 12) <$ $\text{Freq}_{\text{HFLB}}$ $< \text{Max} / (\text{HDR} * 12)$
Freq2	0	1	*14	*28			
Freq3	1	0	*29	*60			
Freq4	1	1	*61	*120			

If there are no signals at HFLB input, the PLL will generate an approximate 2.5 MHz clock to ensure the proper operation of the IIC bus and other control registers.

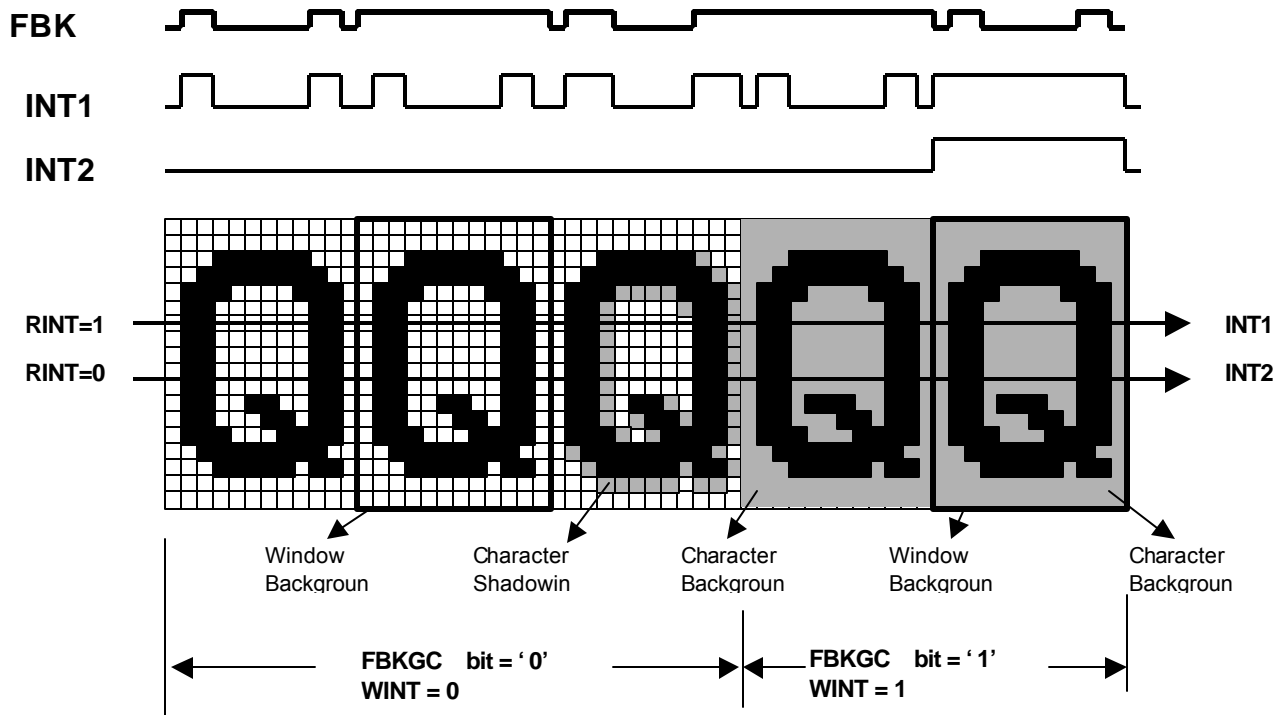
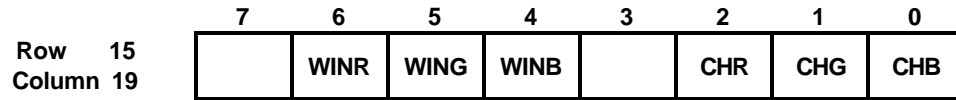


Figure 5. \* FBK & INT Output Timing

**(10) Color Selection for Shadowing/Bordering Effect: Row 15, Column 19**


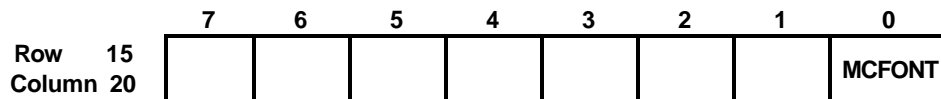
**Shadowing/Bordering Color Control**

**Bit 6-4: WINR/G/B** – These bits control the shadowing color of window 1-4. Refer to Table 7 for color selection. All of these bits will be cleared to '0' after power on.

**Bit 2-0: CHR/G/B** – These bits control the shadowing/bordering color of each character. Refer to Table 7 for color selection. All of these bits will be cleared to '0' after power on.

**TAB 7 Character/Windows' Shadowing Color Selection**

COLOR	R	G	B
Black	0	0	0
Blue	0	0	1
Green	0	1	0
Cyan	0	1	1
Red	1	0	0
Magenta	1	0	1
Yellow	1	1	0
White	1	1	1

**(11) Multi-Color Font Control: Row 15, Column 20**


**Multi-Color Font Control**

**Bit 0: MCFONT** – This bit will enable multi-color fonts addressed from 240 to 255 when it is set to '1'. The default value is '0' after power on and enable standard ROM fonts.

**(12) Adjustments of Width & Height for Windows' Shadowing: Row 15, Column 21, 22**

		7	6	5	4	3	2	1	0
Row 15	Column 21	W4WD1	W4WD0	W3WD1	W3WD0	W2WD1	W2WD0	W1WD1	W1WD0

**Setting of Windows' Shadowing Width**

**WxWD1/0** – This will determine the size of window's width when the SHAD bit of windows control register (row 15 column 1,4,7,10) be set to '1'. The default values are '0 0 ' after power on. Refer to the TAB below for the size adjustments.

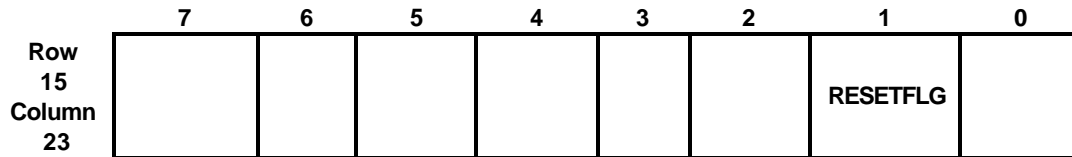
<b>WxWD1/0</b>	<b>(0, 0)</b>	<b>(0, 1)</b>	<b>(1, 0)</b>	<b>(1, 1)</b>	<b>Units</b>
<b>Window Shadowing Width</b>	2	4	6	8	Pixels

		7	6	5	4	3	2	1	0
Row 15	Column 22	W4HT1	W4HT0	W3HT1	W3HT0	W2HT1	W2HT0	W1HT1	W1HT0

**Setting of Window Shadowing Height**

**WxHT1/0** – These bit will determine the window height when the SHAD bit of the window control register (row 15 column 1,4,7,10) is set to '1'. The default values are '0 0 ' after power on. Refer to the TAB below for the size adjustments.

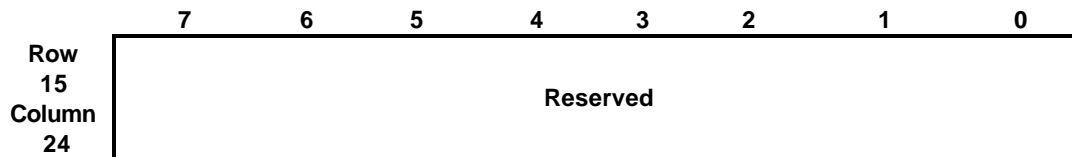
<b>WxHT1/0</b>	<b>(0, 0)</b>	<b>(0, 1)</b>	<b>(1, 0)</b>	<b>(1, 1)</b>	<b>Units</b>
<b>Window Shadowing Height</b>	2	4	6	8	Pixels

**(13) Reset Flag Control Registers**


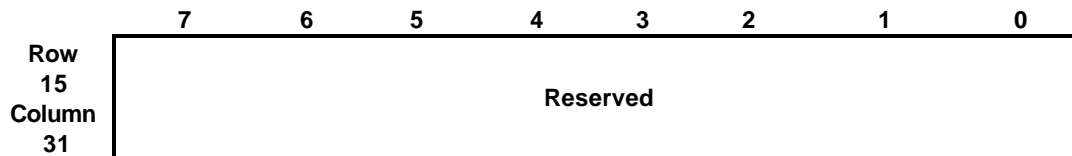
**Bit 1: RESTFLG** – A system reset will clear this bit. User can set this bit first and detect if internal reset circuit has reset the system.

This bit can be read back through IIC bus by external master device, for example MCU.

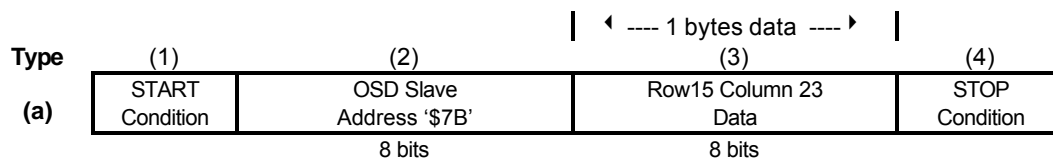
The other bits are reserved.

**(14) Reserved Control Register: Row 15, Column 24 & 31**


This control register is reserved and any data can not be written into this register.



This control register is reserved and any data can not be written into this register.

**IIC Bus Read Mode Operation:**


User must read these bytes of data sequentially and can abort transmission by sending NAK (no acknowledge), Repeat START condition or STOP condition. Every time user sends the START condition (including Repeat START) and slave address \$7B, the NT68275 will respond ACK and then transmit the first byte (content of row5 column3 register). It is prohibited to read more than 1 byte of data.

### IIC Bus Communication:

Figure 6 shows the IIC Bus transmission format. The master initiates a transmission routine by generating a START condition, followed by a slave address byte. Once the address is properly identified, the slave will respond with an ACKNOWLEDGE signal by pulling the SDA line LOW during the ninth SCL clock. Each data byte which then follows must be eight bits long, plus the ACKNOWLEDGE bit, to make up nine bits together. This ACKNOWLEDGE bit is sent by NT68275 at WRITE mode operation and by master, at READ mode. In the WRITE mode, appropriate row and column address information and display data can

be downloaded sequentially from the master in one of the three transmission formats described in Figure 6 Access Register Operation. In the READ mode, the content in some control registers can be transferred to the master. In the cases of no ACKNOWLEDGE or completion of data transfer, the master will generate a STOP condition to terminate the transmission routine. Note that the OSD\_EN bit must be set after all the display information has been sent in order to activate the displaying circuitry of NT68275, so that the received information can then be displayed.

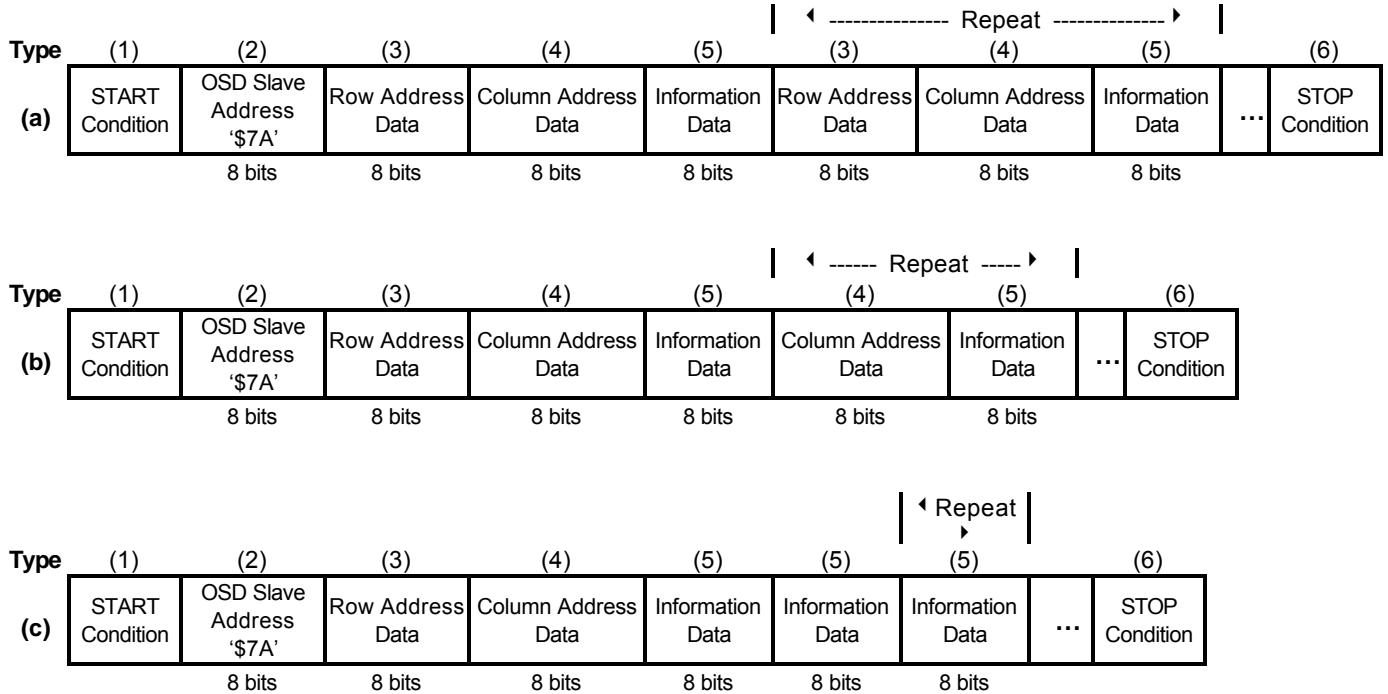
### Write Operation of the Control Registers:

After the proper identification by the receiving device, a data train of arbitrary length is transmitted from the master. There are three transmission formats from (a) to (c) as stated below the Timing section. The data train in each sequence consists of row address, column address and data. In format (a), data must be preceded with the corresponding row address and column address. This format is particularly suitable for updating small amounts of data between different rows. However, if the current information byte has the same row address as the one before, format (b) is recommended. For a full screen pattern change which requires a massive information update, or during power up situation, most of the row and column addresses on either (a) or (b) format will appear to be redundant. A more efficient data transmission format (c) should be applied. This sends the starting row and column addresses

once only, and then treats all subsequent data as display information. The row and column addresses will be automatically incremented internally for each display information data from the starting location.

To differentiate the row and column addresses when transferring data from master, the MSB (Most Significant Bit) is set as in TAB 8 Transmission: '1' represent row, while '0' for column address. Furthermore, to distinguish the column address between format (a), (b) and (c), the sixth bit of the column address is set to '1', which represents format (c), and a '0' for format (a) or (b). There is some limitation on using mix-formats during a single transmission. It is permissible to change the format from (a) to (b), or from (a) to (c), or from (b) to (a), but not from (c) back to (a) or (b).



**IIC Bus Write Operation Timing:**
**Figure. 6 Access Register Write Operation**

**TAB 8. Address Data Transmission for Registers**

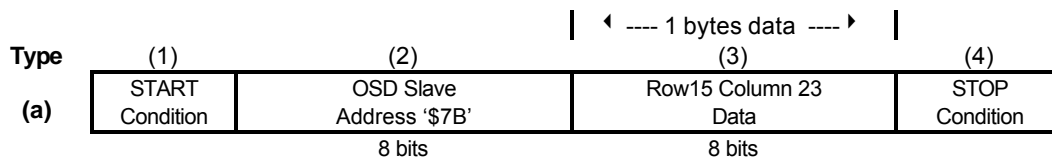
ITEM	No	ADDRESS	B7	B6	B5	B4	B3	B2	B1	B0	Type
Display Register	1	Row	1	0	0	X	R3	R2	R1	R0	(a),(b),(c)
	2	Column	0	0	*Page	C4	C3	C2	C1	C0	(a),(b)
	3	Column	0	1	*Page	C4	C3	C2	C1	C0	(c)
	4	Information Data	D7	D6	D5	D4	D3	D2	D1	D0	
Attribute / Control Register	5	Row	1	0	1	X	R3	R2	R1	R0	(a),(b),(c)
	6	Column	0	0	X	C4	C3	C2	C1	C0	(a),(b)
	7	Column	0	1	X	C4	C3	C2	C1	C0	(c)
	8	Information Data	D7	D6	D5	D4	D3	D2	D1	D0	

\*The page bit will identify the page number of ROM font area. If this bit is set '0', the following information data will address the page 0 ROM font area. Otherwise, it will address the page 1.

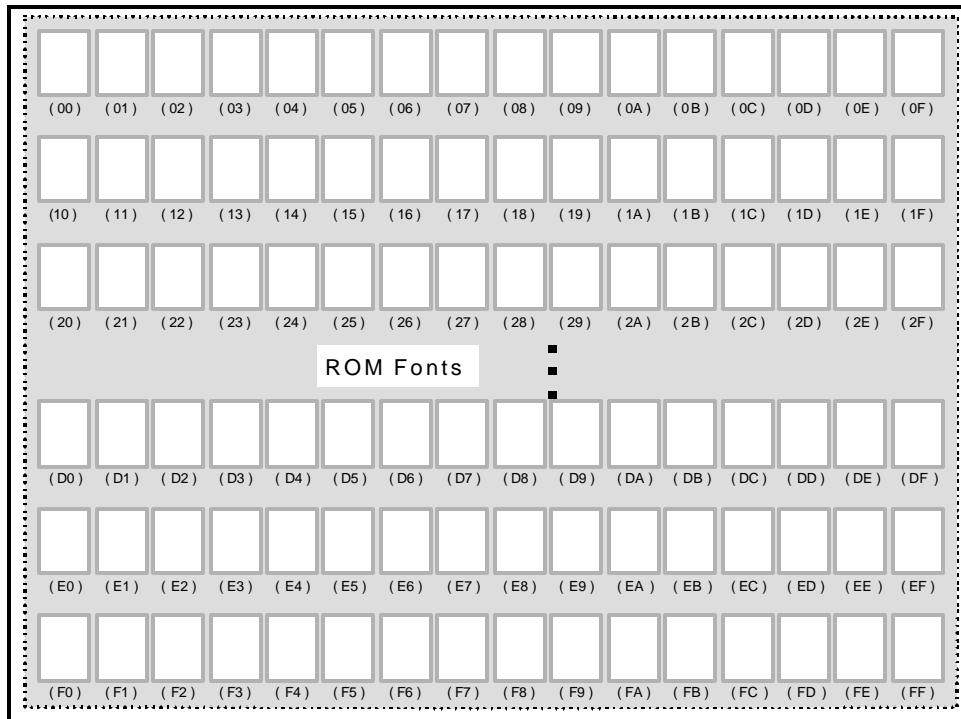
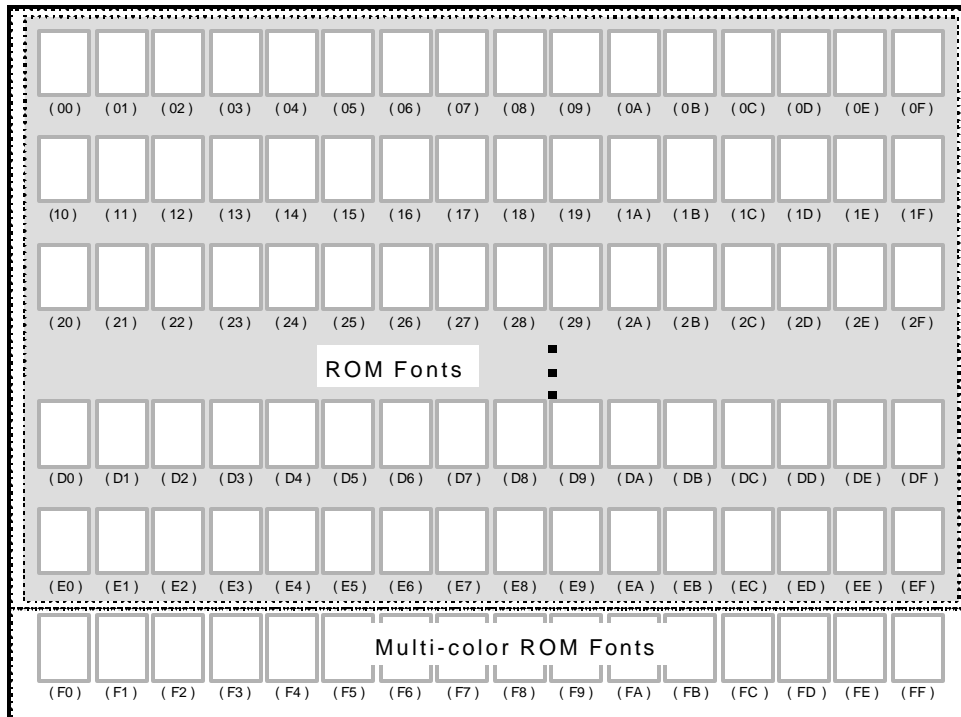
**Read Operation of the Control Registers:**

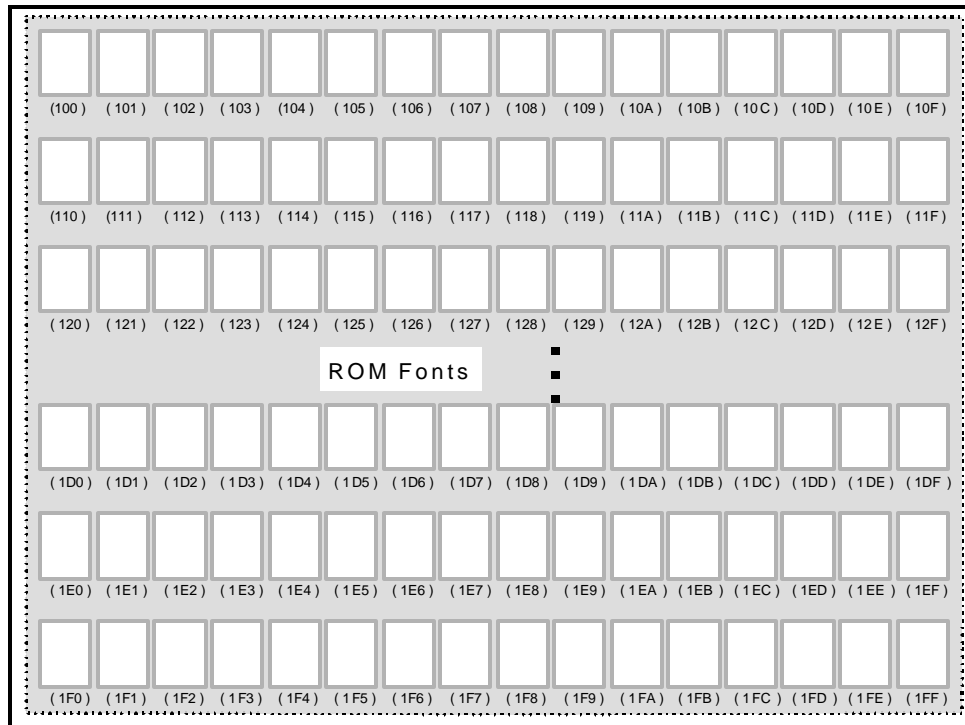
Not all control registers can be read out by the master via IIC bus of READ mode. Bellow listed, after the proper identification of slave address (\$7B) by the NT68275, 1 byte data train is transmitted to the master.

Item	Register	Bytes
1	Row 15 Column 23 Control Register	1

**IIC Bus Read Operation Timing:**
**Figure 7. Access Register Read Operation**


User must read these bytes of data sequentially and can abort transmission by sending NAK (no acknowledge), Repeat START condition or STOP condition. Every time user sends the START condition (including Repeat START) and slave address \$7B, the NT68275 will respond ACK and then transmit first byte (content of row 15 column 23 register). It is prohibited to read more than 1 byte of data.

**Font Access:**

**Figure 8-1. Page 0 including 256 Standard ROM FONT Configuration**

**Figure 8-2. Page 0 including 240 Standard & 16 Multi-color ROM FONT Configuration**



**Figure 8-3. \* Page 1 including 256 Standard ROM FONT Configuration**

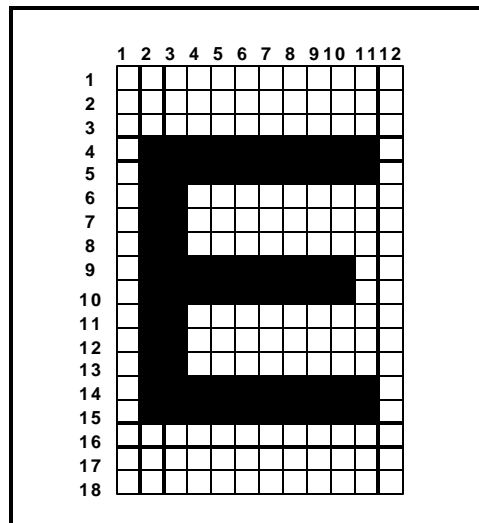


Figure 9-1. 12 \* 18 Dots Font

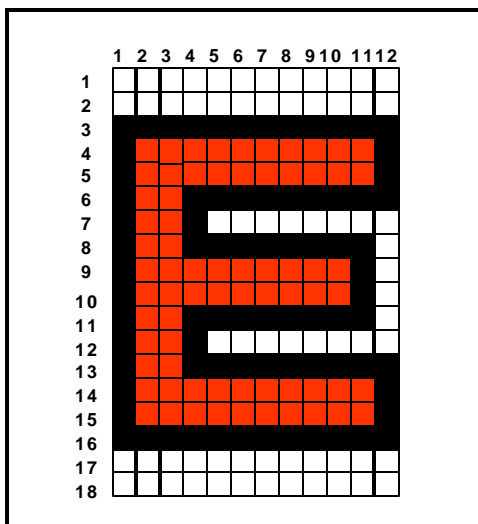


Figure 9-2. Bordering Effect

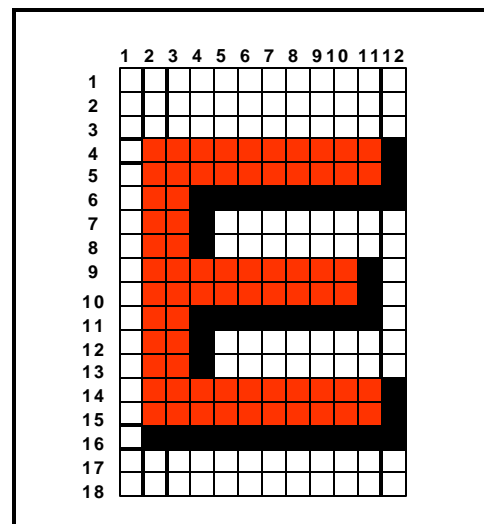
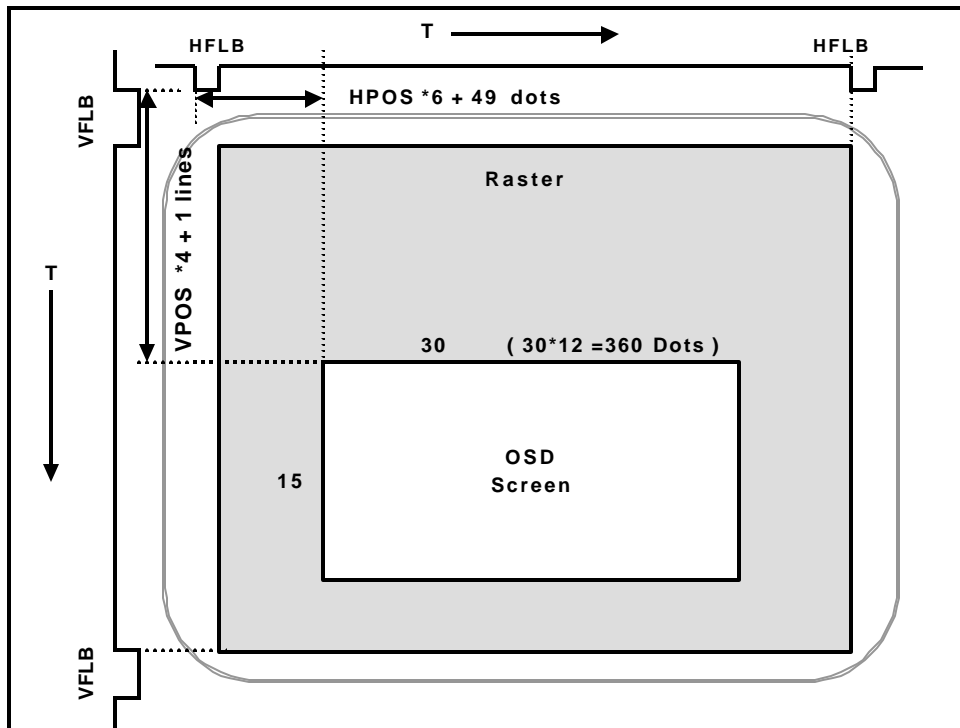


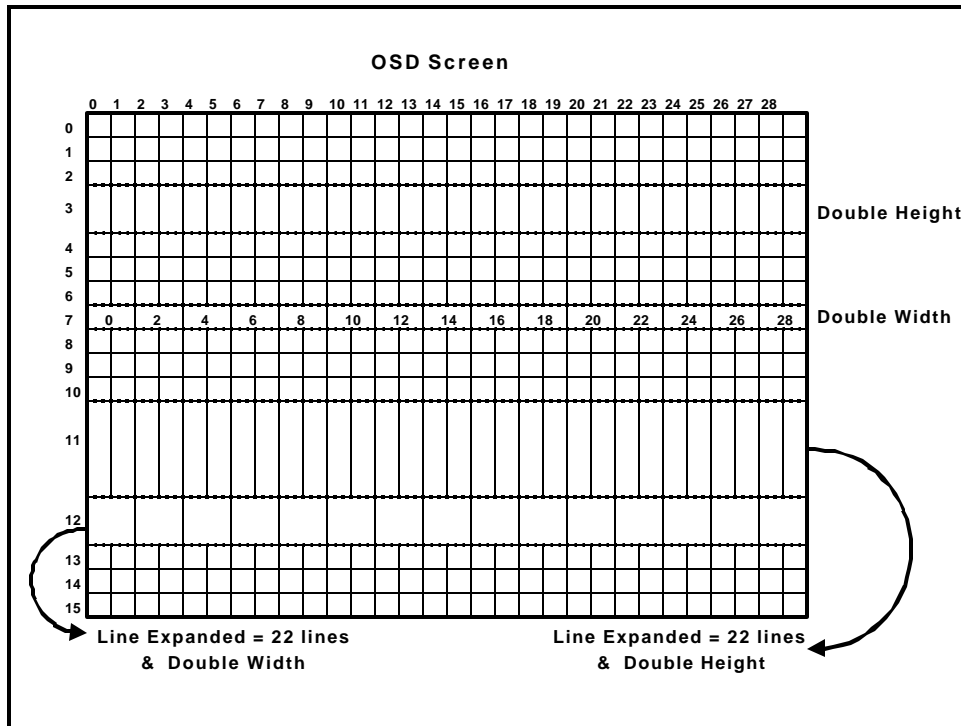
Figure 9-3. Shadowing Effect

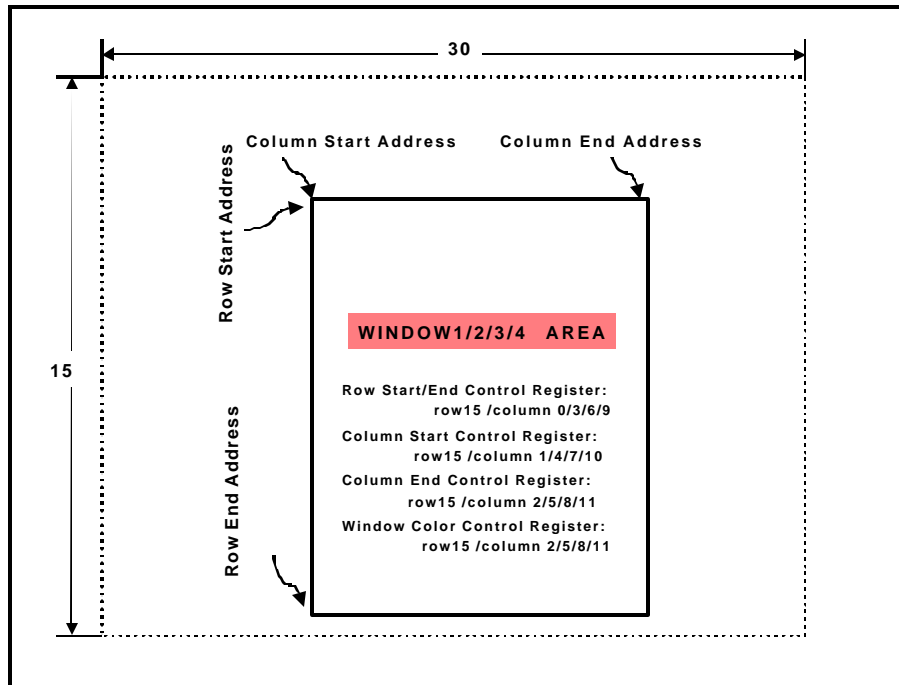
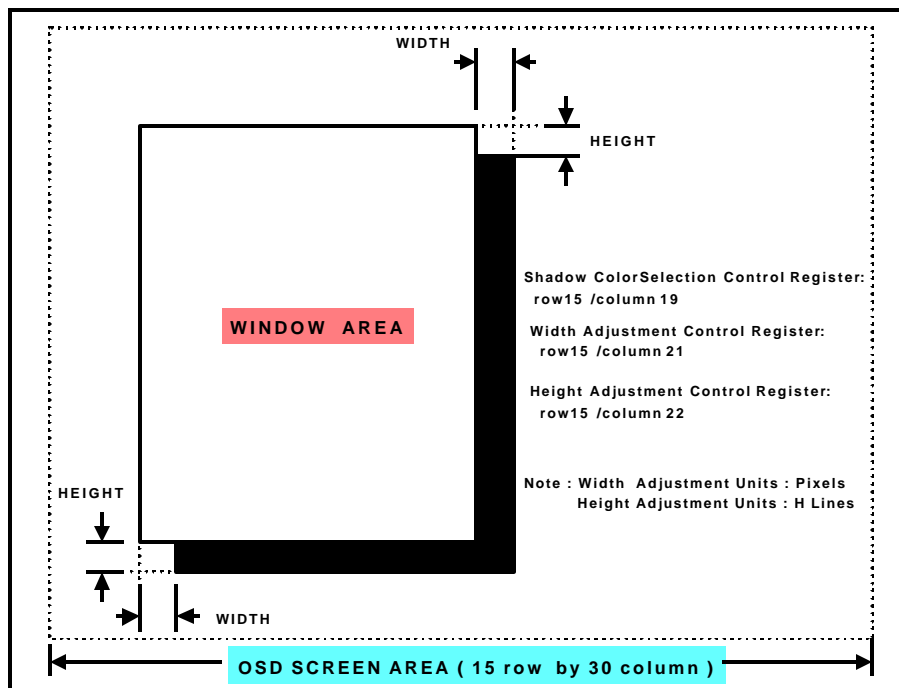
**OSD Screen Position:**

Figure 10 below illustrates the position of all display characters on the screen relative to the leading edge of horizontal and vertical fly-back signals.



**Figure 10. OSD Screen Position**

**OSD Display Format:**

**Figure 11. OSD Display Format**

**OSD Window Setting:**

**Figure 12. Window Size Setting**

**Figure 13. Window Shadowing Setting**



**Characters' Programmable Height:**
**TAB 9. Line Expanded**
**Example 1: If user sets CRH0 = 1, CRH2= 1, CRH3= 1**

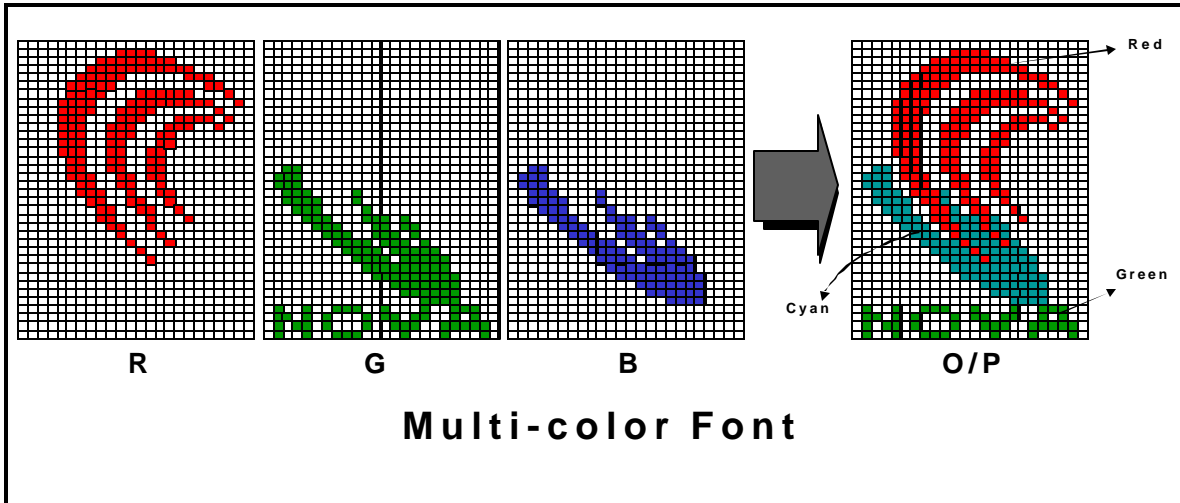
Line	1	2	3	4	5	6	7	8	9	10	11	12	13	14	15	16	17	18
Original Font	!	!	!	!	!	!	!	!	!	!	!	!	!	!	!	!	!	!
CRH0									!									
CRH2			!				!			!					!			
CRH3		!		!		!		!		!		!		!		!		
CH4 – CH 0 <= 18		!	!	!		!	!	!	!	!	!			!	!	!		
Result : 31 lines 18+ 8*CRH3+4*CRH2 +CRH0	!	!!	!!	!!	!	!!	!!	!!	!!	!!	!!	!!	!	!!	!!	!!	!	!

**Example 2: If user sets CRH0 = 1, CRH 3= 1, CRH4 = 1**

Line	1	2	3	4	5	6	7	8	9	10	11	12	13	14	15	16	17	18
Original Font	!	!	!	!	!	!	!	!	!	!	!	!	!	!	!	!	!	!
CRH0									!									
CRH3		!		!		!		!		!		!		!		!		
CRH4		!	!	!	!	!	!	!	!	!	!	!	!	!	!	!	!	!
CH4 – CH 0 >= 18	!	!	!	!	!	!	!	!	!	!	!	!	!	!	!	!	!	!
Result : 35 lines 18+17	!!	!!	!!	!!	!!	!!	!!	!!	!!	!!	!!	!!	!!	!!	!!	!!	!!	!

**Example 3: If user sets CRH1 = 1, CRH3 = 1, CH5 = 0, CH6 = 1**

Line	1	2	3	4	5	6	7	8	9	10	11	12	13	14	15	16	17	18
Original Font	!	!	!	!	!	!	!	!	!	!	!	!	!	!	!	!	!	!
CRH1					!								!					
CRH3		!		!		!		!		!		!		!		!		
CH4 – CH0 < 18		!		!	!	!		!		!		!	!	!		!		
CRH6,5=(1,0)	!	!	!	!	!	!	!	!	!	!	!	!	!	!	!	!	!	!
Result : 46 lines 18+( 8 * CRH3 ) + (2*CRH1)+ 18 * 1	!!	!!!	!!	!!!	!!!	!!!	!!	!!!	!!	!!!	!!	!!!	!!!	!!!	!!	!!!	!!	!!

**Multi-color Font Operation:**


**Figure 14. Multi-Color Font**

Example above, the NOVATEK logo is consisted of four fonts. The R, G, B output channels will send out their corresponding font data and it can then display multiple colors in the same font. When using the multi-color font, it can not be set as black and the bordering and shadowing are not available.

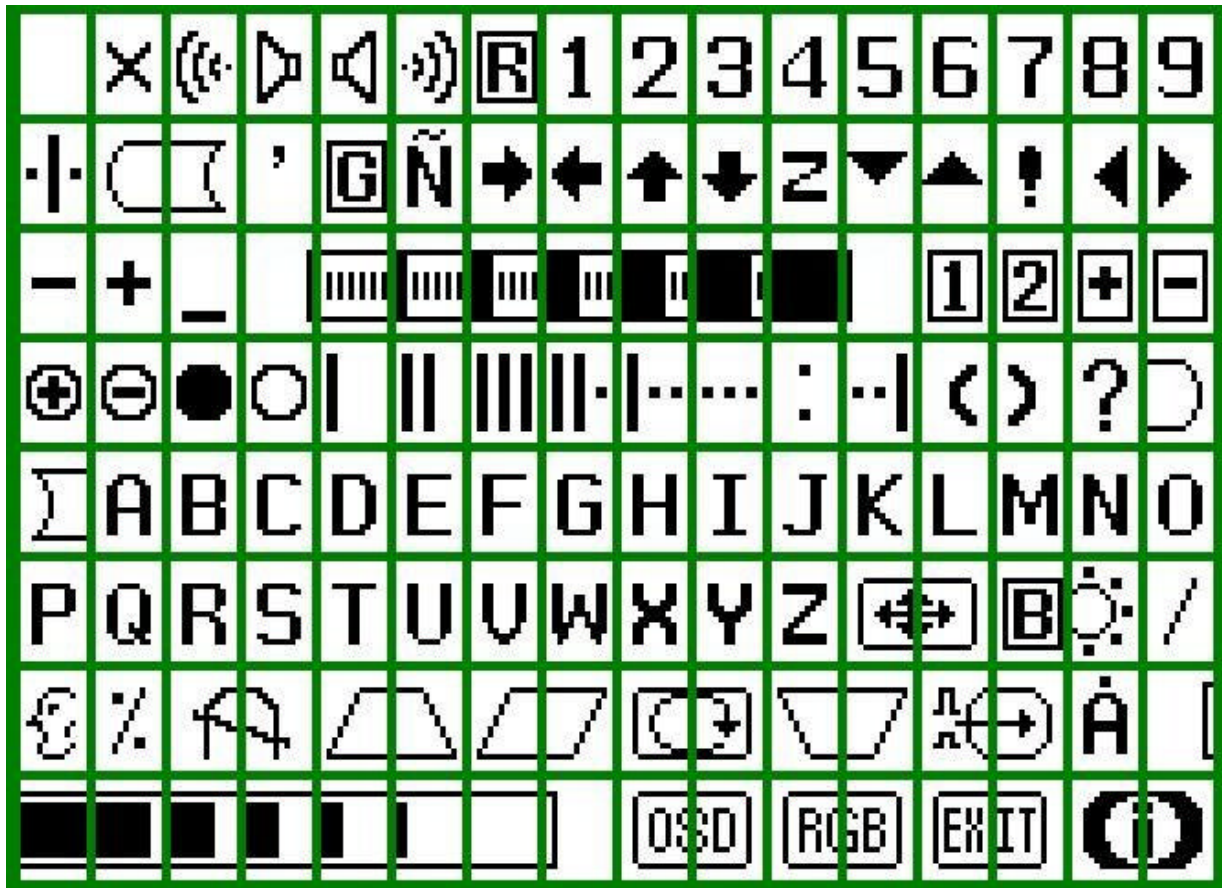


Figure 15-1. Font Code Example

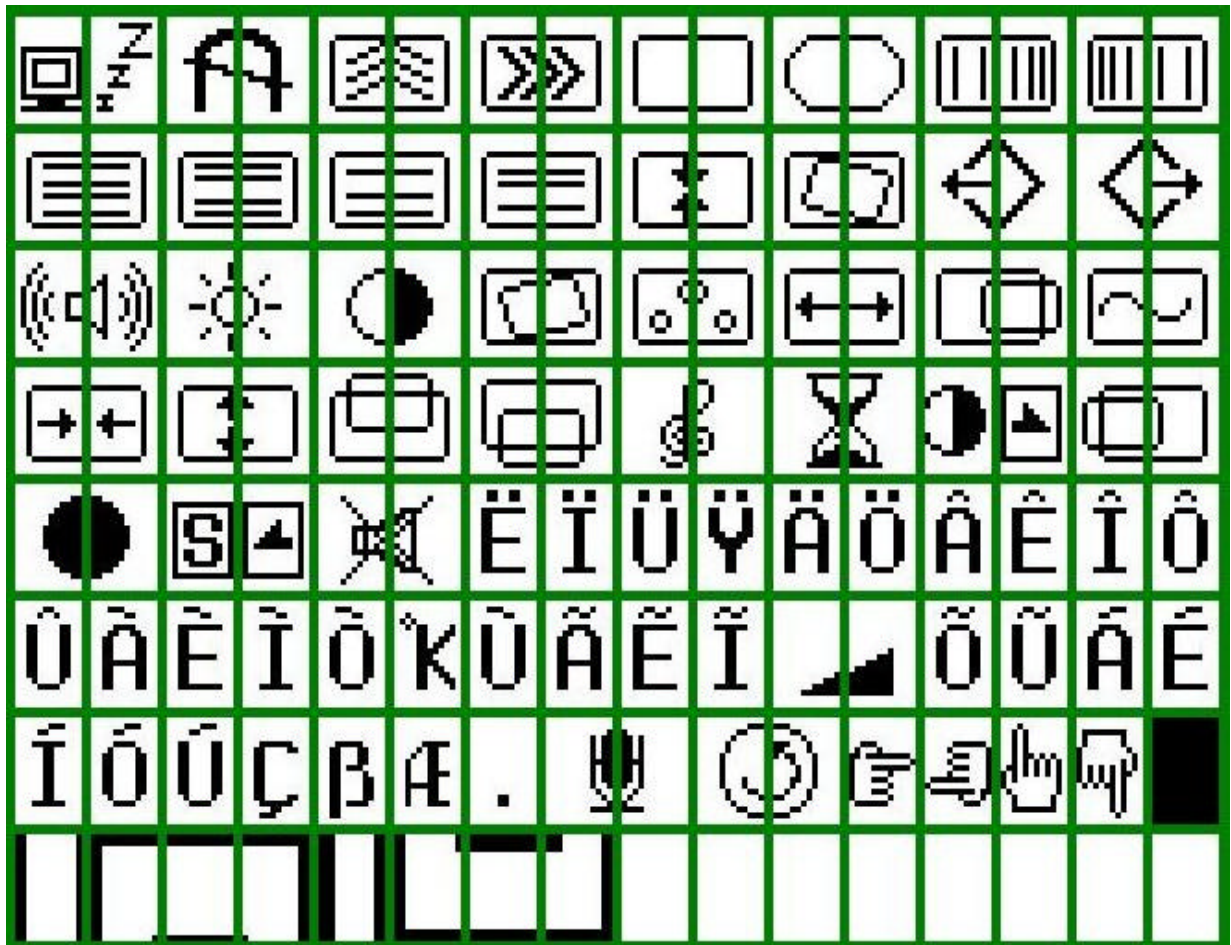
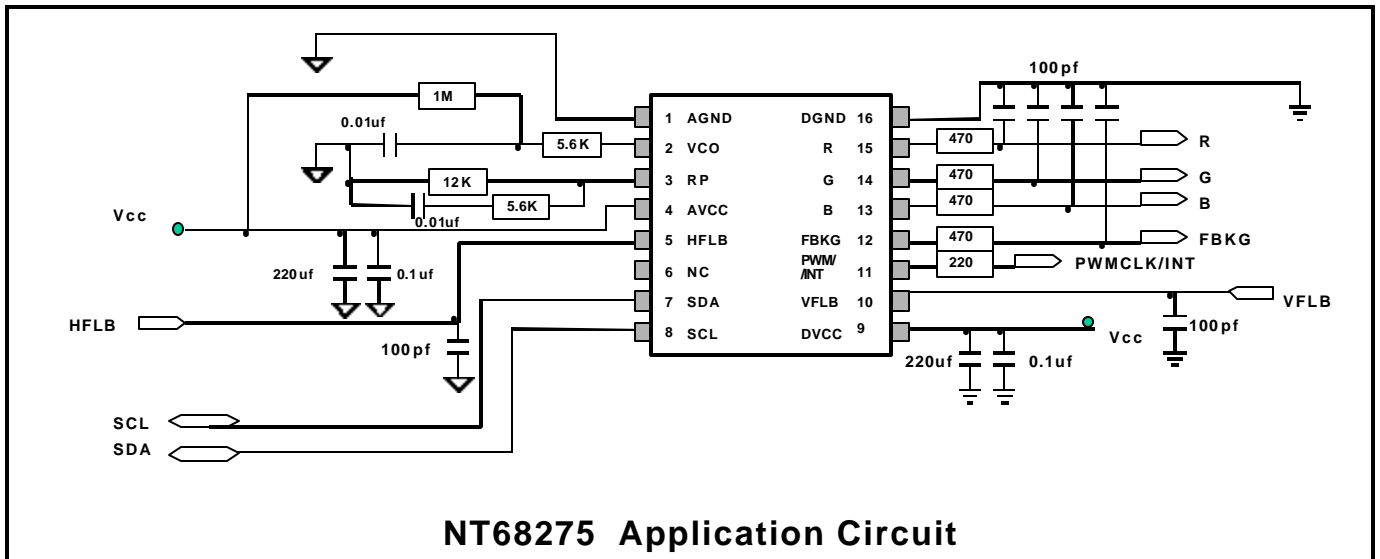
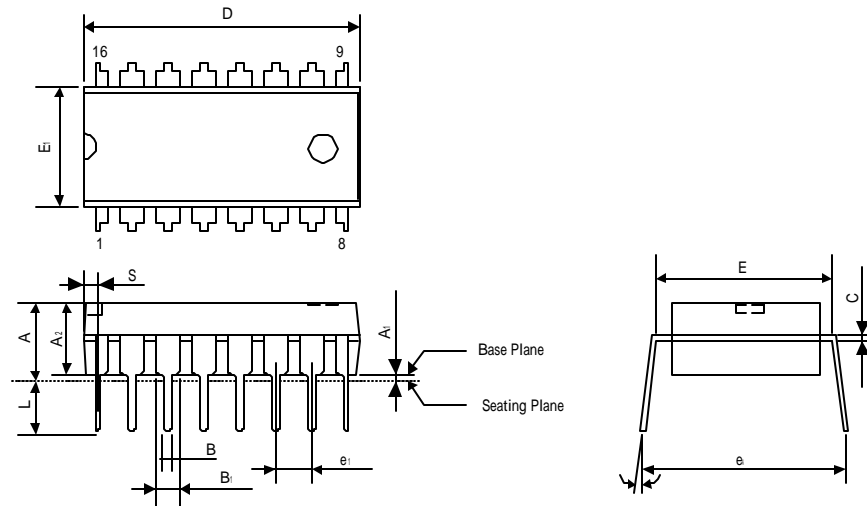


Figure 15-2. Font Code Example (continued)

**Application Circuit**


**Package Information**
**P-DIP 16L Outline Dimensions**

unit: inches/mm



Symbol	Dimension in inch	Dimension in mm
A	0.175 Max.	4.45 Max.
A <sub>1</sub>	0.010 Min.	0.25 Min.
A <sub>2</sub>	0.130±0.010	3.30±0.25
B	0.018 +0.004 -0.002	0.46 +0.10 -0.05
B <sub>1</sub>	0.060 +0.004 -0.002	1.52 +0.10 -0.05
C	0.010 +0.004 -0.002	0.25 +0.10 -0.05
D	0.750 Typ. (0.770 Max.)	19.05 Typ. (19.56 Max.)
E	0.300±0.010	7.62±0.25
E <sub>1</sub>	0.250 Typ. (0.262 Max.)	6.35 Typ. (6.65 Max.)
e <sub>1</sub>	0.100±0.010	2.54±0.25
L	0.130±0.010	3.30±0.25
	0°~ 15°	0°~ 15°
e <sub>A</sub>	0.345±0.035	8.76±0.89
S	0.040 Max.	1.02 Max.

**Note:**

1. The maximum value of dimension D includes end flash.
2. Dimension E<sub>1</sub> does not include resin fins.
3. Dimension S includes end flash.