NX25F011B, NX25F021B, NX25F041B
1M-BIT, 2M-BIT, AND 4M-BIT
SERIAL FLASH MEMORIES WITH 4-PIN SPI INTERFACE

Table of Contents

| | |
|--|-----------|
| 1M-BIT, 2M-BIT, AND 4M-BIT | 1 |
| SERIAL FLASH MEMORIES WITH 4-PIN SPI INTERFACE | 1 |
| FEATURES | 4 |
| DESCRIPTION | 4 |
| FUNCTIONAL OVERVIEW | 5 |
| Pin Descriptions | 5 |
| Package | 5 |
| Serial Data Input (SI) | 6 |
| Serial Data Output (SO) | 6 |
| Serial Clock (SCK) | 6 |
| Chip Select (CS) | 6 |
| Write Protect (WP) | 6 |
| Hold or Ready/Busy (HOLD or R/B) | 6 |
| Power Supply Pins (Vcc and Gnd) | 6 |
| Serial Flash Memory Array | 7 |
| Serial SRAM | 8 |
| Using the SRAM Independent of Flash Memory | 9 |
| Write Protection | 9 |
| Configuration Register | 9 |
| Write Protect Range and Direction, WR[3:0], WD | 10 |
| Read Clock Edge, RCE | 10 |
| Table 2A. Write Protect Range Sector Selection (Hex) | 11 |
| Table 2B. Write Protect Range Sector Selection (Hex) | 11 |
| Table 2C. Write Protect Range Sector Selection (Hex) | 11 |
| HOLD-R/B, HR[1:0] | 11 |
| Status Register Bit Descriptions | 12 |
| Compare Not Equal, CNE | 12 |
| Power Detect, PD | 12 |
| Write Enable/Disable, WE | 12 |
| Command Set | 13 |
| Command Set for the NX25F011B, NX25F021B and NX25F041B Serial Flash Memory | 15 |
| SERIAL FLASH SECTOR COMMANDS | 16 |
| Read From Sector (52H) | 16 |
| Read From Sector with Auto Increment (50H) | 16 |
| Read From Sector Low Frequency (51H) and | 16 |
| Read From Sector Low Frequency with Auto Increment (5BH) | 16 |
| Write Enable (06H) | 16 |
| Write Disable (04H) | 16 |
| Write to Sector Through SRAM (F3H) | 18 |
| SERIAL SRAM COMMANDS | 19 |
| Write to SRAM Command (72H) | 19 |
| Read from SRAM (71H) | 19 |
| Transfer All of SRAM to Sector (F3H) | 20 |
| Transfer All of Sector to SRAM (53H) | 20 |
| Compare Sector to SRAM (8DH) | 21 |
| CONFIGURATION AND STATUS COMMANDS | 21 |
| Read Configuration Register (8CH) | 21 |
| Write Non-Volatile Configuration Register (8AH) | 22 |

Table of Contents (cont'd)

| | |
|---|-----------|
| Read Status Register (84H) | 22 |
| Clear Compare Status (89H) | 23 |
| Set Power Detection Bit (03H) | 23 |
| Reset Power Detection Bit (09H) | 23 |
| Read Device Information Sector (15H) | 24 |
| SPECIAL SECTOR COMMANDS | 24 |
| Erase Sector (F1H) | 24 |
| Erase Block (F4H) | 25 |
| Write-only to Sector (F2H) | 25 |
| COMPATIBILITY COMMANDS FOR 25xxxA SERIES DEVICES | 26 |
| Read from SRAM (81H) | 26 |
| Read Configuration Register (8BH) | 27 |
| Read Status Register (83H) | 27 |
| Transfer Sector to SRAM Clocked (54H) | 28 |
| Compare Sector to SRAM Clocked (86H) | 28 |
| Sector Format | 29 |
| High Data Integrity Applications | 29 |
| Write/Verify Flow | 29 |
| Grouping Static and Frequently Updated Data | 29 |
| ABOSOLUTE MINIMUM RATINGS | 30 |
| OPERATING RANGES | 30 |
| DC ELECTRICAL CHARACTERISTICS (Preliminary) | 30 |
| AC ELECTRICAL CHARACTERISTICS (Preliminary) | 31 |
| SERIAL OUTPUT TIMING | 32 |
| SERIAL INPUT TIMING | 32 |
| HOLD TIMING | 32 |
| PACKAGING INFORMATION | 33 |
| 200-mil Plastic SOIC Package Code: (S) | 33 |
| PACKAGING INFORMATION | 34 |
| 330 mil Plastic SOIC Package Code: (J) | 34 |
| PACKAGING INFORMATION | 35 |
| Plastic TSOP - 28-pins Package Code: Type I (V) | 35 |
| PRELIMINARY DESIGNATION | 36 |
| IMPORTANT NOTICE | 36 |
| ORDERING INFORMATION | 36 |
| LIFE SUPPORT POLICY | 36 |
| Trademarks: | 36 |

FEATURES

- **Flash Storage for Resource-Limited Systems**
 - Ideal for portable/mobile and microcontroller-based applications that store voice, text, and data
- **0.35 μ NexFlash Memory Technology**
 - 1M/2M/4M-bit with 512/1024/2048 sectors
 - Small 264-byte sectors
 - Erase/Write time of 7.5 ms/sector (typical)
 - Optional 8KB (32 sector) block erase for faster programming
- **Ultra-low Power for Battery-Operation**
 - Single 5V or 3V supply for read and erase/write
 - 1 mA standby current, 2.5 mA active @ 3V (typical)
 - Low frequency read command for lower power
- **4-pin SPI Serial Interface**
 - Easily interfaces to popular microcontrollers
 - Clock operation as fast as 20 MHz
- **On-chip Serial SRAM**
 - Single 264-byte Read/Write SRAM buffer
 - Use in conjunction with or independent of Flash
 - Off-loads RAM-limited microcontrollers
- **Special Features for Media-Storage Applications**
 - Byte-level addressing for reads and SRAM writes
 - Transfer or compare sector to SRAM
 - Versatile hardware and software write-protection
 - In-system electronic part number option
 - Removable Serial Flash Module package option
 - Serial Flash Development Kit

DESCRIPTION

The NX25F011B, NX25F021B, and NX25F041B Serial Flash memories provide a storage solution for systems limited in power, pins, space, hardware, and firmware resources. They are ideal for applications that store voice, text, and data in a portable or mobile environment. Using *NexFlash's* patented single transistor EEPROM cell, the devices offer a high-density, low-voltage, low-power, and cost-effective non-volatile memory solution. The devices operate on a single 5V or 3V (2.7V-3.6V) supply for Read and Erase/Write with typical current consumption as low as 2.5 mA active and less than 1 μ A standby. Sector erase/write speeds as fast as 7.5 ms increase system performance, minimize power-on time, and maximize battery life.

The NX25F011B, NX25F021B, and NX25F041B provide 1M-bit, 2M-bit, and 4M-bit of flash memory organized as 512, 1024, or 2048 sectors of 264 bytes each. Each sector is individually addressable through basic serial-clocked commands. The 4-pin SPI serial interface works directly with popular microcontrollers. Special features include: on-chip serial SRAM, byte-level addressing, double-buffered sector writes, transfer/compare sector to SRAM, hardware and software write protection, alternate oscillator frequency, electronic part number, and removable Serial Flash Module package option. Development is supported with the PC-based SFK-SPI Serial Flash Development Kit.

FUNCTIONAL OVERVIEW

An architectural block diagram of the NX25F011B, NX25F021B, and NX25F041B is shown in Figure 2. Key elements of the architecture include:

- SPI Interface and Command Set Logic
- Serial Flash Memory Array
- Serial SRAM and Program Buffer
- Write Protection Logic
- Configuration and Status Registers
- Device Information Sector

Pin Descriptions

Package

The NX25F011B, NX25F021B, and NX25F041B are available in a 28-pin TSOP (Type I) surface mount package. The NX25F011B and NX25F021B are available in either an 8-pin SOIC and a 14-pin TSOP package (contact NexFlash for information on the 14-pin TSOP package). The NX25F041B is also available in a 28-pin SOIC package. See Figure 3A, 3B and Table 1 for pin assignments. All interface and supply pins are on one side of the TSOP package. The “No Connect” (NC) pins are not connected to the device, allowing the pads and the area around them to be used for routing PCB system traces. The devices are also available in a cost-effective and space-efficient removable Serial Flash Module package.

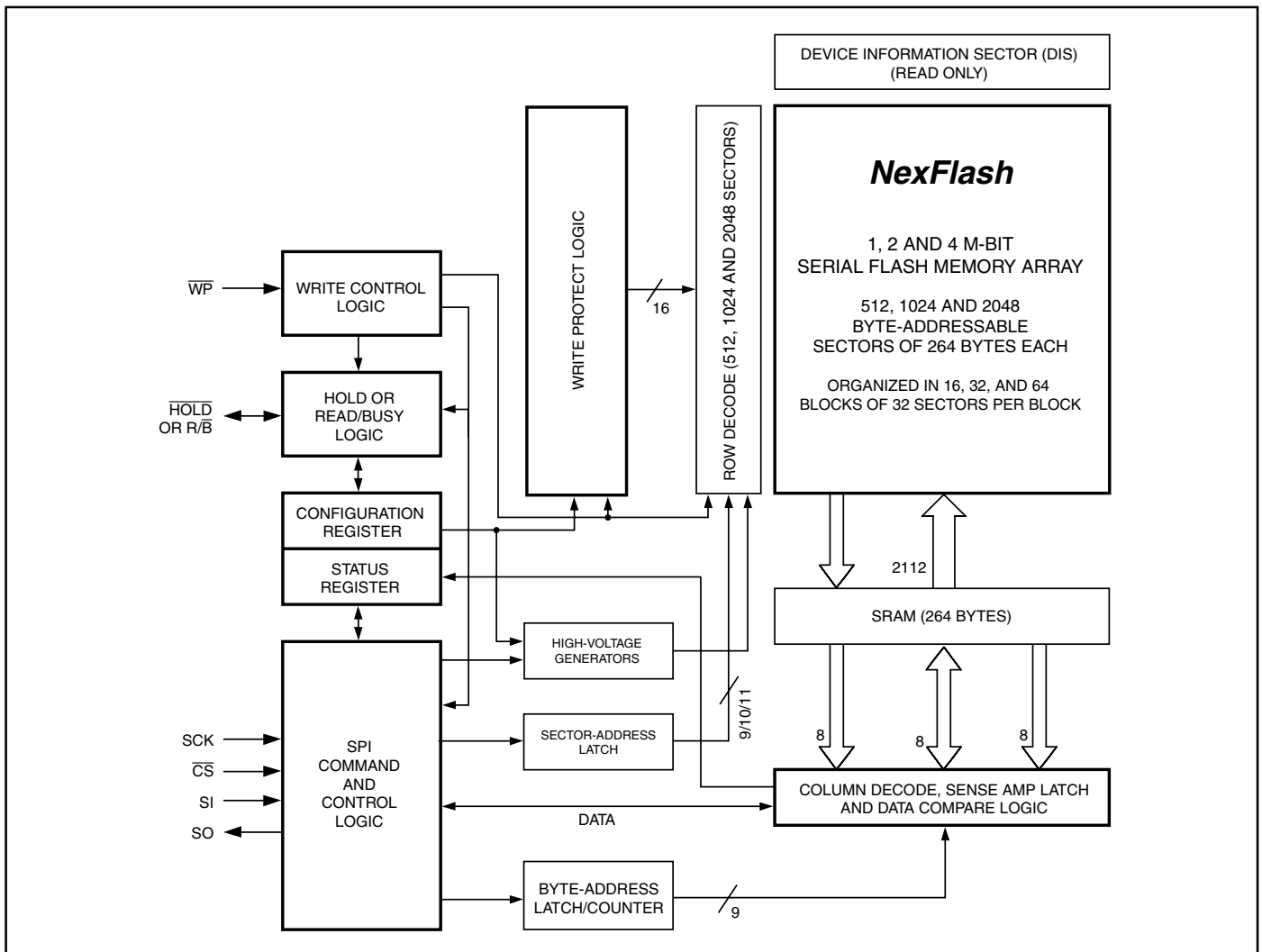

Figure 2. NX25F011B, NX25F021B, and NX25F041B Architectural Block Diagram

Serial Data Input (SI)

The SPI bus Serial Data Input (SI) provides a means for data to be written to (shifted into) the device.

Serial Data Output (SO)

The SPI bus Serial Data Output (SO) provides a means for data to be read from (shifted out of) the device during a read operation. When the device is deselected ($\overline{CS}=1$ or $\overline{HOLD}=0$) the SO pin is in a high-impedance state.

Serial Clock (SCK)

All commands and data written to the Serial Input (SI) are clocked relative to the rising edge of the Serial Clock (SCK). All data read from the Serial Data Output (SO) is clocked relative to the falling or rising edge of SCK as specified in the non-volatile configuration register. The data output clock edge is factory-programmed to the default condition of the falling edge, allowing compatibility with standard SPI systems. Clock rates of up to 20 MHz are supported.

Chip Select (\overline{CS})

The NX25F011B, NX25F021B, and NX25F041B are selected for operation when the Chip Select input (\overline{CS}) is asserted low. SCK must be low when (\overline{CS}) is asserted to a low state. Upon power-up, an initial low-to-high transition of \overline{CS} is required before any command sequence will be acknowledged. The device can be deselected to a non-active state when \overline{CS} is brought high. Once deselected,

the SO pin will enter a high-impedance state and power consumption will decrease to standby levels unless programming is in process, in which case standby will resume when programming is complete.

Write Protect (\overline{WP})

The Write Protect input (\overline{WP}) works in conjunction with the write protect range set in the configuration register bits. When \overline{WP} is asserted (active low) the entire Flash memory array is write protected. When high, any Flash memory sector can be written to unless its address is within the write protect range that is set in the configuration register.

Hold or Ready/Busy (\overline{HOLD} or R/ \overline{B})

This multifunction pin can serve either as a Hold input (\overline{HOLD}) or as a Ready-Busy output (R/ \overline{B}). The pin function is user-programmable through the non-volatile configuration register. Factory-programmed as a no-connect, the pin can be reconfigured as a Ready-Busy output or as a Hold input by setting the configuration register. See the configuration register section of this data sheet for further details.

Power Supply Pins (Vcc and GND)

The NX25F011B, NX25F021B, and NX25F041B support single power supply Read and Erase/Write operations in 5V and 3V versions. Typical active power is as low as 2.5 mA for the 3V version with standby current less than 1 μ A.

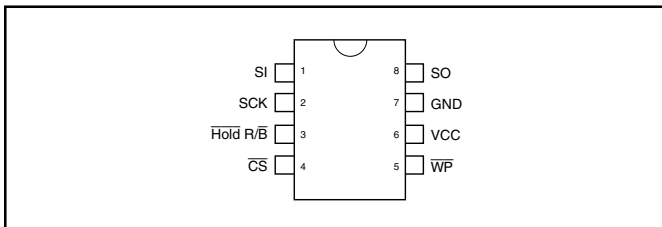

**Figure 3A. NX25F011B and NX25F021B
 Pin Assignments, 8-Pin SOIC**

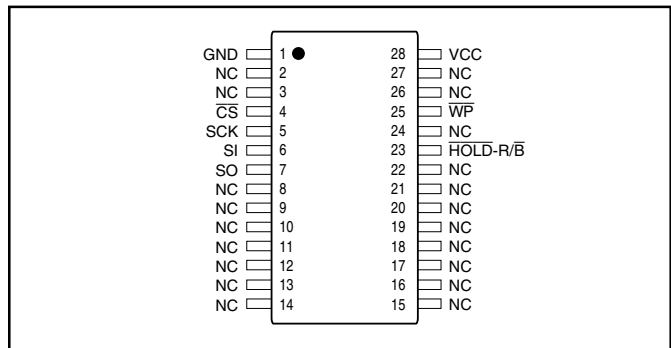

**Figure 3C. NX25F041B
 Pin Assignments, 28-Pin SOIC**

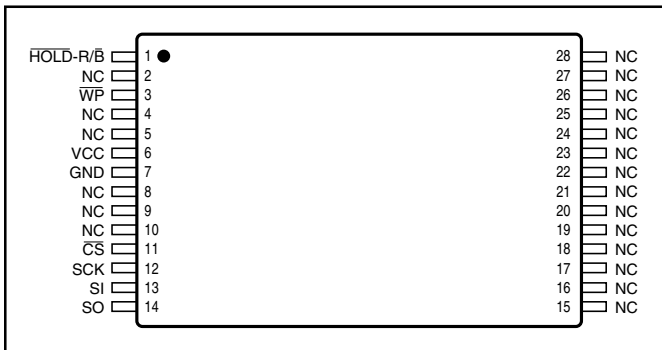

**Figure 3B. NX25F011B, NX25F021B, and NX25F041B
 Pin Assignments, 28-Pin TSOP (Type I)**

Table 1. Pin Descriptions

| | |
|-------------------------|--------------------------------|
| SI | Serial Data Input |
| SO | Serial Data Output |
| SCK | Serial Clock Input |
| \overline{CS} | Chip Select Input |
| \overline{WP} | Write Protect Input |
| Hold, R/ \overline{B} | Hold Input or Read Busy Output |
| Vcc | Power Supply |

Serial Flash Memory Array

The NX25F011B, NX25F021B, and NX25F041B Serial Flash memory arrays are organized as 512, 1024, and 2048 sectors of 264-bytes (2,112 bits) each, as shown in Figure 4. The block size of the device is 32 sectors, yielding 16, 32 and 64 blocks for the NX25F011B, NX25F021B, and NX25F041B.

The Serial Flash memory of the NX25F011B, NX25F021B, and NX25F041B is byte-addressable for read operations. This allows a single byte, or specified sequence of bytes, to be read without having to clock an entire 264-byte sector out of the device. Data can be read directly from a sector in the Flash memory array by using a *Read from Sector* command.

Data can be written to the Flash memory array one sector (264-bytes) at a time through the Serial SRAM using a *Write to Sector* command or a *Transfer SRAM to Sector* com-

mand. No pre-erase is needed. Instead, the device incorporates an auto-erase-before-write feature that automatically erases the addressed sector at the beginning of the write operation. After a sector has been written, the memory array will become busy while it is programming the specified non-volatile memory cells of that sector. This busy time will not exceed t_{WP} during which time the Flash array is unavailable for read or write access. The device can be tested to determine the array's availability using the Ready/Busy status that is available during most read commands, through the status register, or on the Ready/Busy pin.

After sector programming is complete and the device is ready, it is recommended to verify the data in the sector with the data in the SRAM using the compare command, (see Write/Verify Flow towards the end of this data sheet).

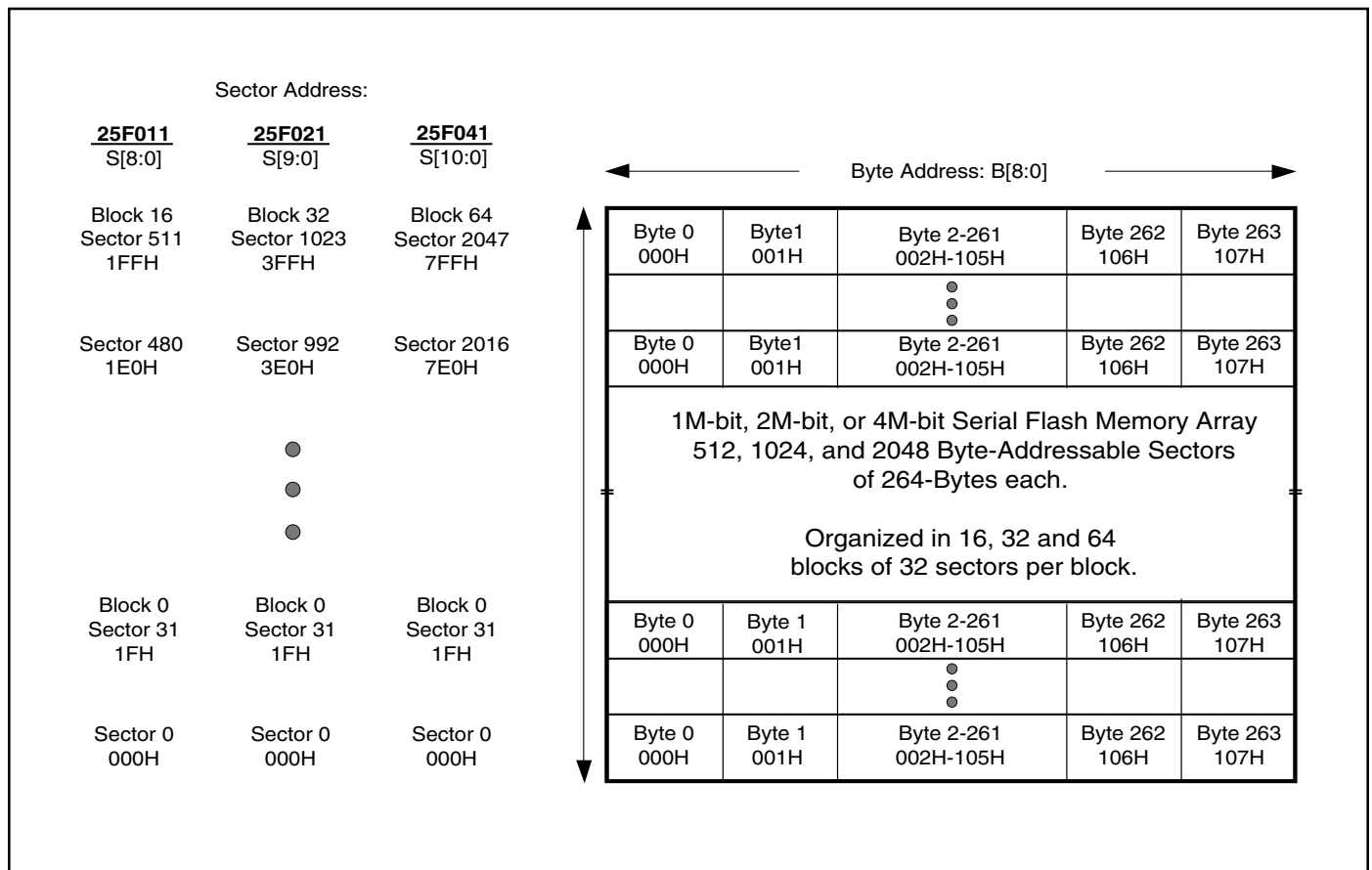

Figure 4. NX25F011B, NX25F021B, and NX25F041B Serial Flash Memory Array

Serial SRAM

One of the most powerful features of the NX25F011B, NX25F021B, and NX25F041B is the integrated Serial SRAM. The main purpose of the Serial SRAM is to serve as the primary buffer for sector data to be written into the Serial Flash memory array. Using the *Write to Sector* command, data is first shifted into the SRAM from the SPI bus. When the command sequence has been completed, the entire 264-bytes is written to the selected sector. See Erase/Write cycle timing (t_{WP}).

The SRAM is fully byte-addressable. Thus, the entire 264-bytes, a single byte, or a sequence of bytes can be read from, or written to the SRAM. This allows the SRAM to be used as a temporary work area for read-modify-write operations prior to a sector write.

The *Transfer Sector to SRAM* command allows the contents of a specified sector of Flash memory to be moved to

the SRAM. This can be useful when only a portion of a sector needs to be altered. In this case the sector is first transferred to the SRAM, where modifications are made using the *Write to SRAM* command. Once complete, a *Transfer SRAM to Sector* command is used to update the sector.

The *Compare Sector* command allows the contents of the SRAM to be compared with the specified sector in memory. The result of the compare is set in the status register. This command is useful for performing a fast verify of the last sector write operation (see Write/Verify Flow towards the end of this data sheet). This command can be useful when re-writing multi-sector files that have only minor changes from the previous write. If the new data in the SRAM is the same as the previously written data, the sector write can be skipped. Used in this way, the command saves time that would have been used for re-programming. It also extends the endurance of the Flash memory cells.

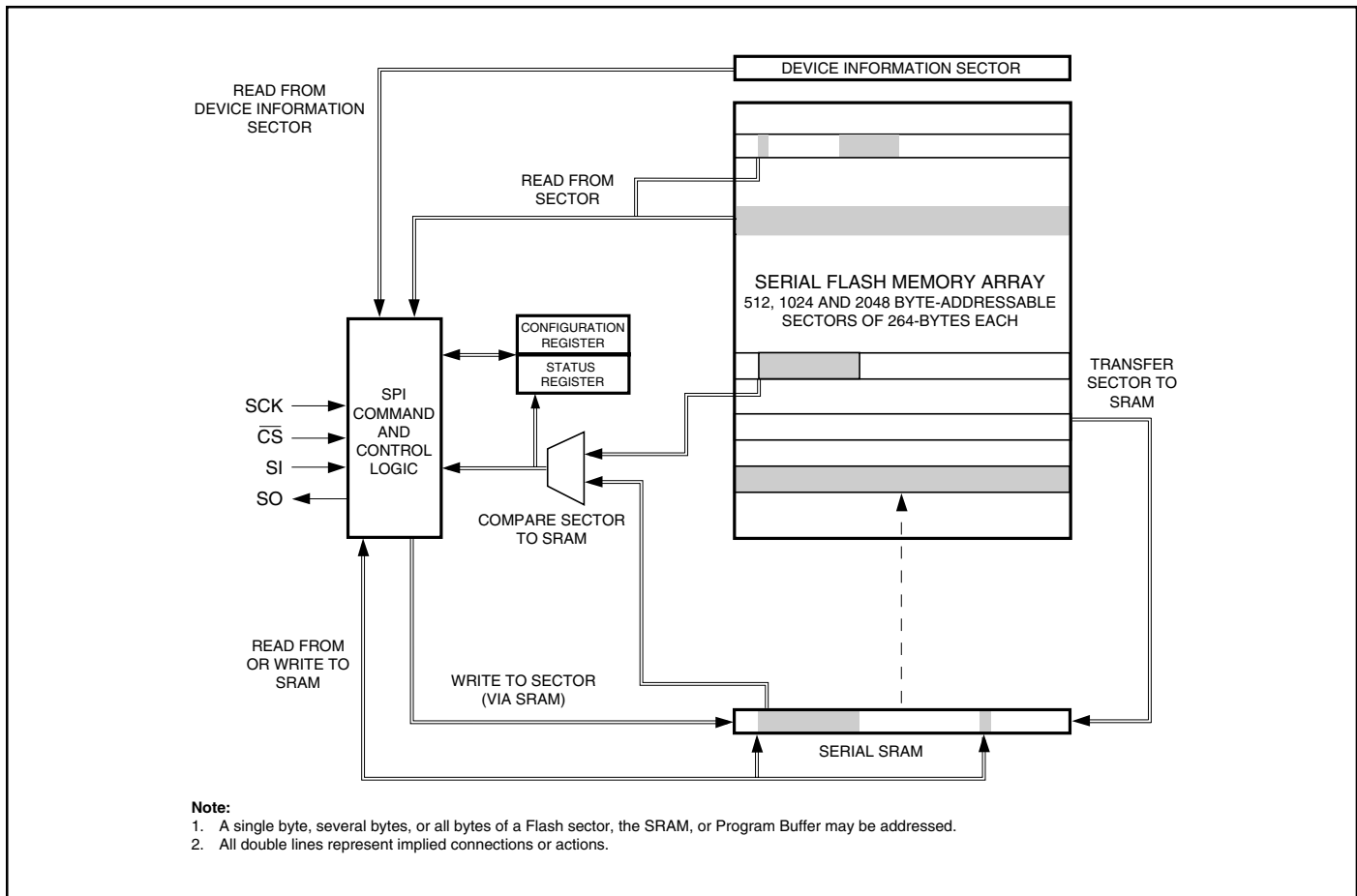

Figure 5. Command Relationships of the SPI Interface, Serial Flash Memory Array and SRAM

Using the SRAM Independent of Flash Memory

The SRAM can be used independently of Flash memory operations for lookup tables, variable storage, or scratch pad purposes. If the Flash memory needs to be written to while SRAM is being used for a different purpose, the contents can be temporarily stored to a sector and then transferred back again when needed. The SRAM can be especially useful for RAM-limited microcontroller-based systems, eliminating the need for external SRAM and freeing pins for other purposes. It can also make it possible to use small pin-count microcontrollers, since only a few pins are needed for the interface instead of the 20-40 pins required for parallel bus-oriented Flash devices.

Write Protection

The NX25F011B, NX25F021B, and NX25F041B provide advanced software and hardware write protection features. Software-controlled write protection of the entire array is handled using the *Write Enable* and *Write Disable* commands. Hardware write protection is possible using the Write Protect pin (\overline{WP}). Write-protecting a portion of Flash memory is accommodated by programming a write protect range in the configuration register. For applications needing a portion of the memory to be permanently write-protected or a fixed configuration register value, a onetime programmable write protection feature is supported. Contact *NexFlash* for further information.

Configuration Register

The Configuration Register stores the current configuration of the $\overline{HOLD-R/B}$ pin, read clock edge and write protect range (Figure 7). The configuration register is accessed using the *Write and Read Configuration Register* commands. The non-volatile configuration register will maintain its setting even when power is removed.

To avoid unnecessary programming of the configuration register, and to save time during power-up, the configuration register should be read upon power-up and compared to the intended setting before sending a Write Configuration Register command (Figure 6).

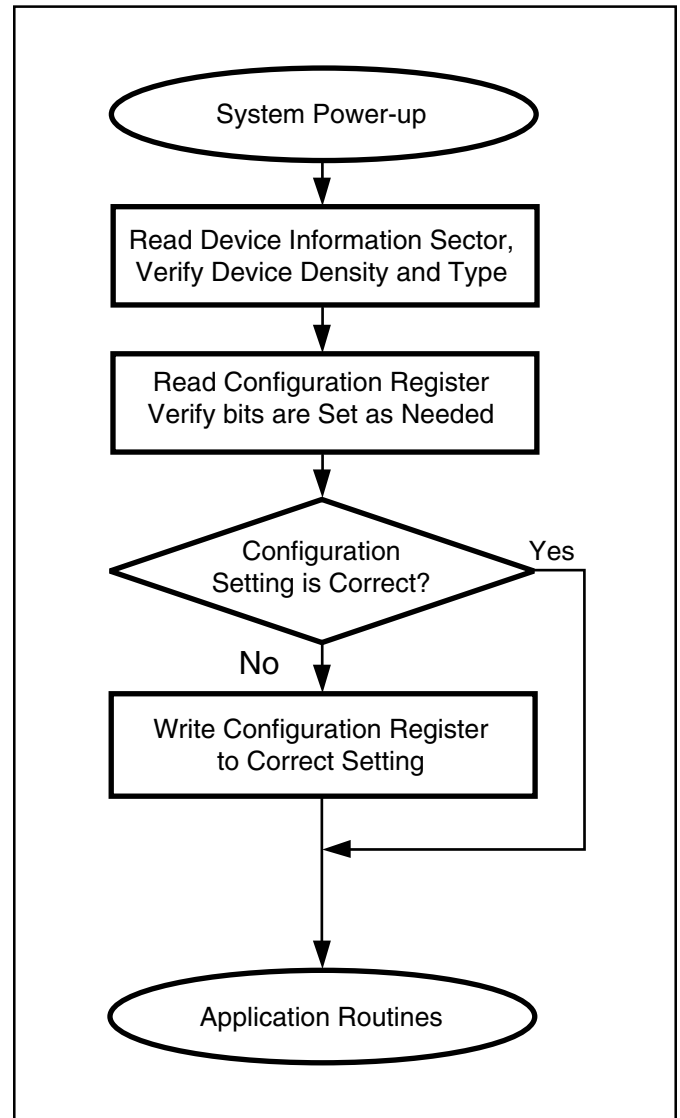

Figure 6. Flow Chart for Checking the Configuration Register upon Power-up

The factory default setting for the configuration register is CF8-CF0 is: 0 0000 1001 B (write protect range = none, read uses falling edge of the clock, and pin 1 = no connect). Bits CF15-CF9 are reserved. When writing to the configuration register CF15-CF9 should be 0. When reading, the settings of CF15-CF9 should be ignored.

Write Protect Range and Direction, WR[3:0], WD

The write protect range and direction bits WR[3:0] and WD are located at configuration bits CF[7:4] and CF[3] respectively. The write protect range and direction bits select how the array is protected. They work in conjunction with the \overline{WP} input pin, valid only if \overline{WP} is inactive (high). WR[3:0] can select write protection of all sectors, none of the sectors, or specific sectors grouped in blocks of 32 (~8 KB). The WD bit specifies whether the protected block range starts from the first sector, address 0 (000H), or from the last sector (1FFH for the NX25F011B, 3FFH for the NX25F021B, and 7FF for the NX25F041B). Table 2A, 2B and 2C lists the write protect sector range for the devices.

Once protected, all further writes to sectors within the range will be ignored. The factory default setting is with no write protected sectors, WR=[0,0,0,0] and WD=1.

Read Clock Edge, RCE

The Read Clock Edge bit (RCE) is located at configuration bit location CF[2]. It selects which edge of the clock (SCK) is used while reading data out of the device. Although the SPI protocol specifies that data is written during the rising edge and read on the falling edge of the clock, if required, the output can be driven on the rising edge of the clock by setting the configuration registers RCE bit to a 1. Using the rising edge of clock for data reads may be beneficial to the timing of some high-speed systems. The factory default setting is the falling edge of SCK for standard SPI.

RCE=0 Read data is output on the falling edge of SCK (Standard SPI).

RCE=1 Read data is output on the rising edge of SCK (Fast SPI).

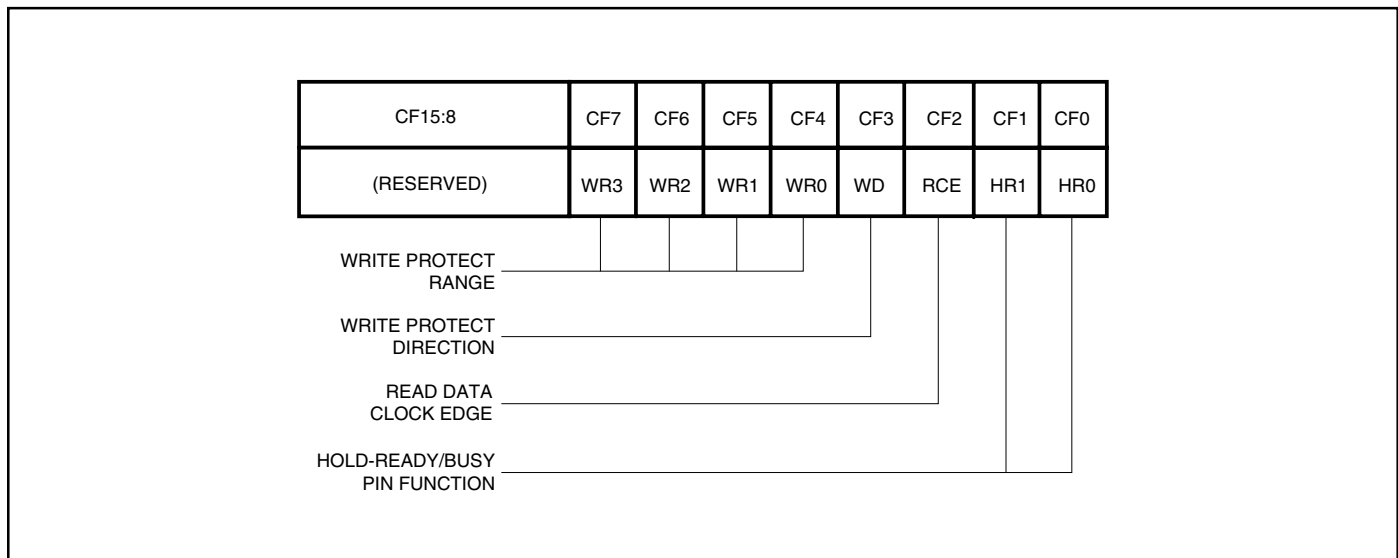

Figure 7. Configuration Register Bit Locations

Table 2A. Write Protect Range Sector Selection (Hex)

| Write Protect Range Config. Bits | | | | (NX25F011B) Write Protected Sectors | |
|----------------------------------|-----|-----|-----|-------------------------------------|------------|
| WR3 | WR2 | WR1 | WR0 | WD=0 | WD=1 |
| 0 | 0 | 0 | 0 | None | None |
| 0 | 0 | 0 | 1 | 000 - 01FH | 1 E0 - 1FF |
| 0 | 0 | 1 | 0 | 000 - 03FH | 1 C0 - 1FF |
| 0 | 0 | 1 | 1 | 000 - 05FH | 1 A0 - 1FF |
| 0 | 1 | 0 | 0 | 000 - 07FH | 1 80 - 1FF |
| 0 | 1 | 0 | 1 | 000 - 09FH | 1 60 - 1FF |
| 0 | 1 | 1 | 0 | 000 - 0BFH | 1 40 - 1FF |
| 0 | 1 | 1 | 1 | 000 - 0DFH | 1 20 - 1FF |
| 1 | 0 | 0 | 0 | 000 - 0FFH | 1 00 - 1FF |
| 1 | 0 | 0 | 1 | 000 - 11FH | 0 E0 - 1FF |
| 1 | 0 | 1 | 0 | 000 - 13FH | 0 C0 - 1FF |
| 1 | 0 | 1 | 1 | 000 - 15FH | 0 A0 - 1FF |
| 1 | 1 | 0 | 0 | 000 - 17FH | 0 80 - 1FF |
| 1 | 1 | 0 | 1 | 000 - 19FH | 0 60 - 1FF |
| 1 | 1 | 1 | 0 | 000 - 1BFH | 0 40 - 1FF |
| 1 | 1 | 1 | 1 | ALL | ALL |

Table 2C. Write Protect Range Sector Selection (Hex)

| Write Protect Range Config. Bits | | | | (NX25F041B) Write Protected Sectors | |
|----------------------------------|-----|-----|-----|-------------------------------------|-------------|
| WR3 | WR2 | WR1 | WR0 | WD=0 | WD=1 |
| 0 | 0 | 0 | 0 | None | None |
| 0 | 0 | 0 | 1 | 000 - 01FH | 7 E0 - 7FFH |
| 0 | 0 | 1 | 0 | 000 - 03FH | 7 C0 - 7FFH |
| 0 | 0 | 1 | 1 | 000 - 05FH | 7 A0 - 7FFH |
| 0 | 1 | 0 | 0 | 000 - 07FH | 7 80 - 7FFH |
| 0 | 1 | 0 | 1 | 000 - 09FH | 7 60 - 7FFH |
| 0 | 1 | 1 | 0 | 000 - 0BFH | 7 40 - 7FFH |
| 0 | 1 | 1 | 1 | 000 - 0DFH | 7 20 - 7FFH |
| 1 | 0 | 0 | 0 | 000 - 0FFH | 7 00 - 7FFH |
| 1 | 0 | 0 | 1 | 000 - 11FH | 6 E0 - 7FFH |
| 1 | 0 | 1 | 0 | 000 - 13FH | 6 C0 - 7FFH |
| 1 | 0 | 1 | 1 | 000 - 15FH | 6 A0 - 7FFH |
| 1 | 1 | 0 | 0 | 000 - 17FH | 6 80 - 7FFH |
| 1 | 1 | 0 | 1 | 000 - 19FH | 6 60 - 7FFH |
| 1 | 1 | 1 | 0 | 000 - 1BFH | 6 40 - 7FFH |
| 1 | 1 | 1 | 1 | ALL | ALL |

Table 2B. Write Protect Range Sector Selection (Hex)

| Write Protect Range Config. Bits | | | | (NX25F021B) Write Protected Sectors | |
|----------------------------------|-----|-----|-----|-------------------------------------|------------|
| WR3 | WR2 | WR1 | WR0 | WD=0 | WD=1 |
| 0 | 0 | 0 | 0 | None | None |
| 0 | 0 | 0 | 1 | 000 - 01FH | 3 E0 - 3FF |
| 0 | 0 | 1 | 0 | 000 - 03FH | 3 C0 - 3FF |
| 0 | 0 | 1 | 1 | 000 - 05FH | 3 A0 - 3FF |
| 0 | 1 | 0 | 0 | 000 - 07FH | 3 80 - 3FF |
| 0 | 1 | 0 | 1 | 000 - 09FH | 3 60 - 3FF |
| 0 | 1 | 1 | 0 | 000 - 0BFH | 3 40 - 3FF |
| 0 | 1 | 1 | 1 | 000 - 0DFH | 3 20 - 3FF |
| 1 | 0 | 0 | 0 | 000 - 0FFH | 3 00 - 3FF |
| 1 | 0 | 0 | 1 | 000 - 11FH | 2 E0 - 3FF |
| 1 | 0 | 1 | 0 | 000 - 13FH | 2 C0 - 3FF |
| 1 | 0 | 1 | 1 | 000 - 15FH | 2 A0 - 3FF |
| 1 | 1 | 0 | 0 | 000 - 17FH | 2 80 - 3FF |
| 1 | 1 | 0 | 1 | 000 - 19FH | 2 60 - 3FF |
| 1 | 1 | 1 | 0 | 000 - 1BFH | 2 40 - 3FF |
| 1 | 1 | 1 | 1 | ALL | ALL |

HOLD-R/B, HR[1:0]

The Hold-Ready/Busy (HOLD-R/B) bits HR1 and HR0 are located at bits CF[1:0] of the configuration register. These two bits select one of four possible functions: No Connect, HOLD input, R/B Output, or R/B Output with open drain. The factory setting for the pin is “No Connect”.

| HR1 | HR0 | Pin Configuration |
|-----|-----|-------------------------|
| 0 | 0 | HOLD input |
| 0 | 1 | No Connect |
| 1 | 0 | R/B Output (Open Drain) |
| 1 | 1 | R/B Output |

Configured as a R/B output, the pin can serve as a system interrupt. When R/B is high, the array is ready to be programmed. When R/B is low, it is busy programming. If configured with an open-drain, an external pull-up resistor should be used.

As a HOLD input, the pin can be used in conjunction with the CS and SCK pin to suspend a serial command sequence without resetting the command. This can be useful if a command is in process and a higher priority task on the same SPI bus needs to be attended to. To

suspend a command, \overline{HOLD} must be brought low while \overline{CS} and SCK are low. With \overline{HOLD} low, further data on the SI pin is ignored (even while SCK is clocked) and the SO pin goes to a high-impedance state. To resume the command sequence, \overline{HOLD} must be brought high when \overline{CS} and SCK are low. See timing diagrams.

Status Register Bit Descriptions

The status register provides status of the Flash array's Ready/Busy condition (R/B), transfers between the SRAM and program buffer (TX), Write-Enable/Disable (WE), and Compare Not Equal (CNE). The register can be read using the Read Status Register command (Figure 8).

Ready/Busy Status, BUSY

The BUSY status bit is located at bit ST[7] of the status register. Testing the BUSY bit is one of several ways to check Ready/Busy status of the array. At power-up the BUSY bit is reset to 0.

BUSY=1 The device is busy programming.
 BUSY=0 The device is ready for further use.

SRAM Transfer All or Compare All, TR

The TR status bit is located at bit ST[6] of the status register. The bit provides status primarily for use during the *Transfer All Sector to SRAM* command and *Compare All Sector to SRAM* command. An active state 1 indicates a transfer is in process and the SRAM Array is not available for use. The device will indicate a BUSY state while the TR bit is active. Upon power up the TR bit resets to 0.

TR=1 Transfer or Compare All in Process.
 TR=0 Transfer or Compare All not in Process.

Write Enable/Disable, WE

The WE status bit is located at bit ST[4] of the status register. The bit provides write protect status of global *Write Enable and Write Disable* commands. Upon power-up the WE bit resets to 0.

WE=1 Write Enabled, array can be written to.
 WE=0 Write Disabled, array can not be written to.

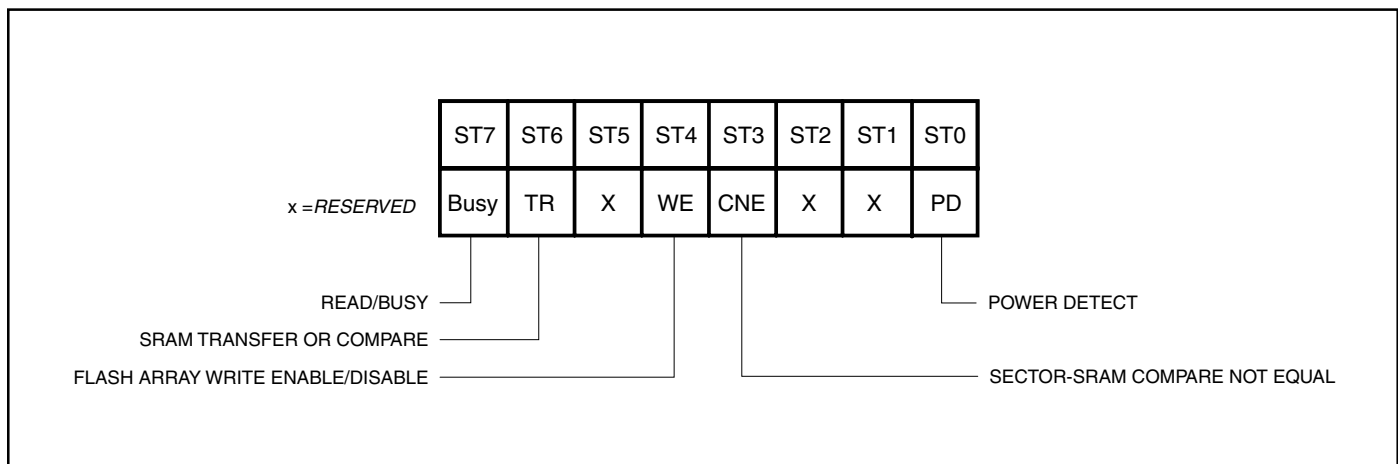

Figure 8. Status Register Bit Locations

Compare Not Equal, CNE

The CNE status bit is located at bit ST[3] of the status register. The bit provides a cumulative comparison result during a *Compare Sector with SRAM* command. The CNE bit is reset to a 0 upon power-up or after a Clear Compare Bit command is executed.

CNE=1 Sector and SRAM contents are not equal.
 CNE=0 Sector and SRAM are equal or CNE bit reset.

Power Detect, PD

The Power Detect bit works in conjunction with the Set Power Detection and Reset Power Detection Commands and is primarily used for removable media applications. The Set Power Detect Command must be issued before the PD bit can be used for power detection.

PD=0 Power has been removed
 PD=1 Power has not been removed

Command Set

The NX25F011B, NX25F021B, and NX25F041B have a powerful command set that is fully controlled through the SPI bus. Command relations are shown in Figure 5 and a list of commands and their associated address, status, clock, and data bytes are shown in Table 3. Detailed clock timing of the *Read Sector* and *Write Sector* command sequences are shown in Figures 9 and 10.

After power up, a device enters an idle state that will maintain until \overline{CS} pin is asserted low. All commands are entered from the SPI serial data input (SI) pin on the rising edge of SCK while \overline{CS} is asserted low. All command, address, and configuration bits are shifted into the device with most-significant-bit-first. Data bits read from the device are shifted out with least significant byte first (i.e., byte-00H, byte-01H,...). The bit order within each byte is most-significant-bit first (i.e., D7,...D0). All commands are completed by asserting the \overline{CS} pin high.

Note that the entire 264-byte contents of a Flash sector or the SRAM does not have to be accessed all at once. Read, Write, Transfer Clocked, and Compare Clocked commands allow for byte addressing. Thus a single byte, or clocked sequence of bytes, can be accessed at any starting location within the 264-byte boundary as specified by the byte-address field.

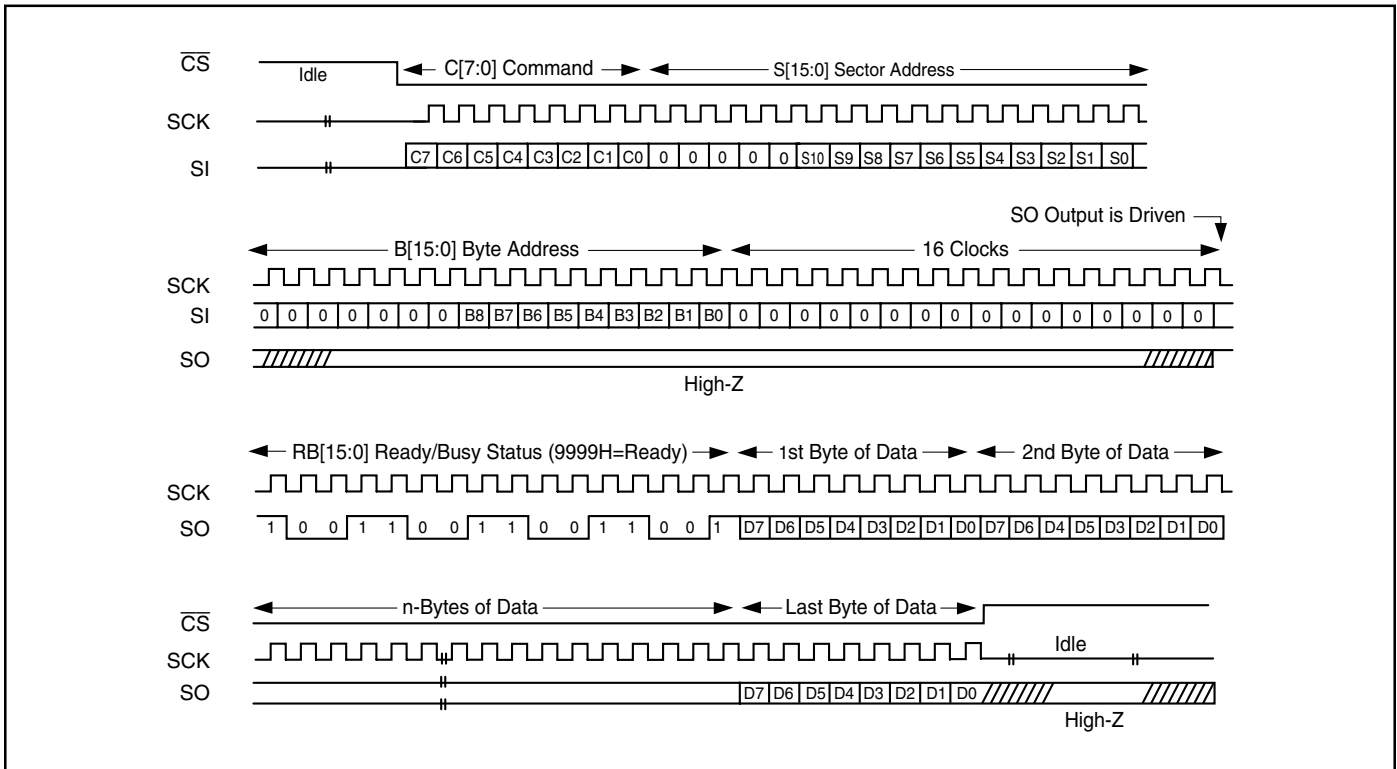

Figure 9. Read from Sector Command Sequence

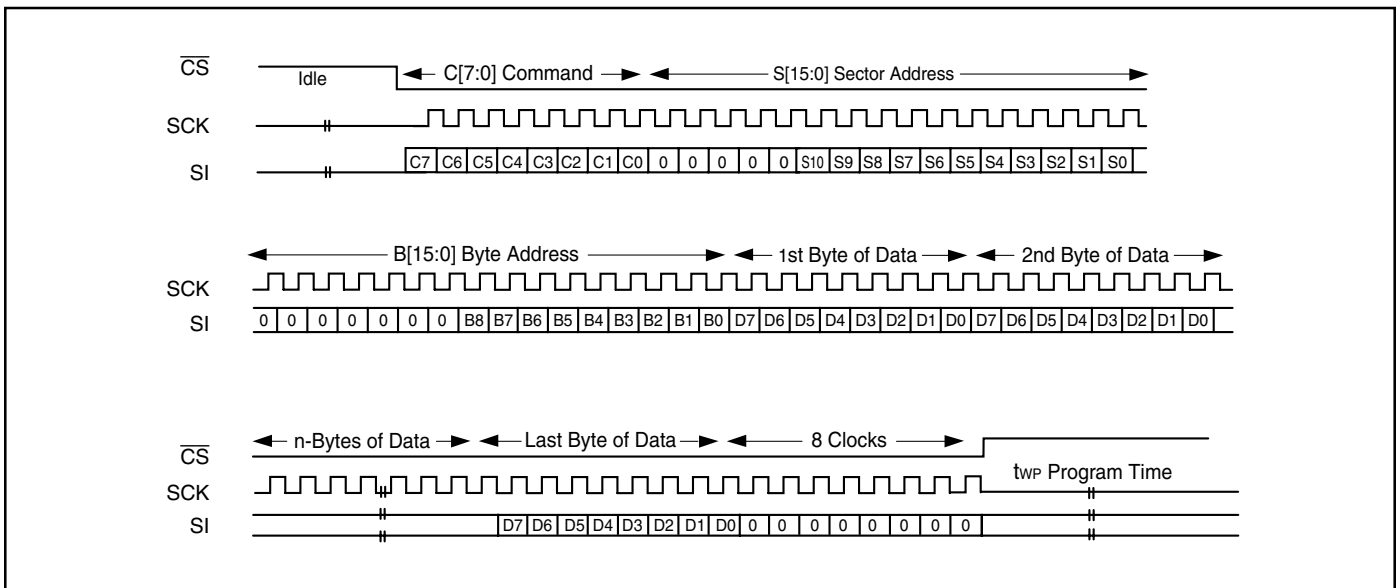

Figure 10. Write to Sector Command Sequence

Command Set for the NX25F011B, NX25F021B and NX25F041B Serial Flash Memory

| Command Name | Byte 0 | Byte 1-2 | Byte 3-4 | n-bytes (<i>Italics indicate device output</i>) | | |
|--|--------|------------------------|--------------|--|---------------------------------------|----------------------|
| Sector Commands | | | | | | |
| Read From Sector | 52H | Sector address | Byte address | 0000H | <i>Ready/Busy</i> | <i>Read Data</i> |
| Read From Sector w/AutoInc ⁽³⁾ | 50H | Sector address | 0000H | 0000H | <i>Ready/Busy</i> | <i>Read Data</i> |
| Read From Sector Low Freq. | 51H | Sector address | Byte address | 0000H | <i>Ready/Busy</i> | <i>Read Data</i> |
| Read From Sector w/AutoInc Low Freq ⁽³⁾ | 5BH | Sector address | 0000H | 0000H | <i>Ready/Busy</i> | <i>Read Data</i> |
| Write Enable ⁽¹⁾ | 06H | 00H | | | | |
| Write Disable ⁽¹⁾ | 04H | 00H | | | | |
| Write to Sector (through SRAM) ⁽²⁾ | F3H | Sector address | Byte address | Write Data | 00H | |
| Serial SRAM Commands | | | | | | |
| Write to SRAM ^{(2),(3)} | 72H | Byte address | Write data | 00H | | |
| Read from SRAM ^{(1),(3)} | 71H | Byte address | 00H | | <i>Read Data</i> | |
| Transfer all of SRAM to Sector | F3H | Sector address | 0000H | | | |
| Transfer all of Sector to SRAM ⁽³⁾ | 53H | Sector address | 0000H | 0000H | | |
| Compare Sector to SRAM ⁽³⁾ | 8DH | Sector address | Byte address | 0000H | | |
| Configuration and Status Commands | | | | | | |
| Read Configuration ^{(1),(3)} | 8CH | <i>Configuration</i> | | | | |
| Write Non-Volatile Configuration Register ⁽¹⁾ | 8AH | Configuration | 0000H | | | |
| Read Status Register ^{(1),(3)} | 84H | <i>Status (8 bits)</i> | | | | |
| Clear Compare Status ⁽¹⁾ | 89H | | | | | |
| Set Power Detection Bit ^{(1),(3)} | 03H | | | | | |
| Reset Power Detection Bit ^{(1),(3)} | 09H | | | | | |
| Read Device Information Sector ^{(3),(4)} | 15H | 0000H | Byte address | 0000H | <i>Ready/Busy</i> | <i>DIS Data</i> |
| Special Sector Commands | | | | | | |
| Erase Sector | F1H | Sector address | 0000H | | | |
| Erase Block | F4H | Block address | 0000H | | | |
| Write-Only to Sector through SRAM | F2H | Sector address | Byte address | Write Data | 00H | |
| Compatibility Commands for 25xxxA Series Devices | | | | | | |
| Read from SRAM | 81H | 0000H | Byte address | 0000H | <i>Read/Busy</i> | <i>Read Data</i> |
| Write to SRAM | 82H | 0000H | Byte address | Write data | 00H | |
| Read Configuration Register | 8BH | 0000H | 0000H | 0000H | <i>Ready/Busy</i> | <i>Configuration</i> |
| Read Status Register | 83H | 0000H | 0000H | 0000H | <i>Ready/Busy</i> | <i>Status</i> |
| Transfer Sector to SRAM Clocked | 54H | Sector address | Byte address | N*00H | 00H | |
| Compare Sector to SRAM Clocked | 86H | Sector address | Byte address | 0000H | <i>Ready/Busy Bit compare of data</i> | |

Notes:

1. Command may be used when device is busy
2. Command may not be used when device is busy and TR bit=0
3. New "B" series command
4. Warning: Read description of these commands before using to ensure reliable operation.

SERIAL FLASH SECTOR COMMANDS

Read From Sector (52H)

Reading from a sector is accomplished by first bringing \overline{CS} low then shifting in the *Read from Sector* command (52H) followed by its 16-bit “sector-address” field. Although the sector-address field is 16-bits, only bits S[8:0] for the NX25F011B (0-1FFH), S[9:0] for the NX25F021B (0-3FFH), S[10:0] for the NX25F041B (0-7FFH) are used. The uppermost sector address bits are not used but must be clocked using 0 for data. Next a 16-bit “byte-address” field is clocked into the device to designate the starting location within the 264-byte sector. Only B[8:0] of the byte-address field are used; the uppermost bits are not used but must be clocked in (use 0 for data). Only byte-addresses of 0 to 107H (264 bytes) are valid. Following the byte-address field, 16 control clocks are required with data=0.

The Serial Data Output (SO) will change from a high-impedance state and begin to drive the output with Ready/Busy status RB[15:0]. If SO uses the rising edge of clock (configuration register RCE=1), the output will be driven after the last control clock. If SO uses the falling edge of clock (RCE=0), the output will be driven on the next falling edge of clock. If the array is not busy, the output status will be 9999H, followed by the sector data on the SO pin. If the array is busy, the status will be 6666H, and the command should be terminated and restarted after a ready state occurs. The data field is shifted out with the least significant byte first (i.e., byte-00H, byte-01H, ...). The bit order within each byte is the most significant bit first (i.e., D7,...D0). The

byte-address is internally incremented to the next higher byte address as the clock continues. When the highest byte-address (107H) is reached, the address counter rolls over to byte-0H and continues to increment. Asserting the \overline{CS} pin high completes (or terminates) the command. Detailed timing for the *Read from Sector* command is shown in Figure 10.

Read From Sector with Auto Increment (50H)

The *Read from sector with Auto Increment* command operates similar to the standard Read from Sector command except that after the last bit of the current sector is clocked the next sequentially addressed sector will be automatically selected for reading without requiring the nine byte command sequence to be issued. This allows the entire device or a large number of sectors to be read out with a single command.

Read From Sector Low Frequency (51H) and

Read From Sector Low Frequency with Auto Increment (5BH)

The *Read From Sector at Low Frequency* command (51H) and *Read From Sector Low Frequency with Auto Increment* command (5BH) can reduce power consumption during read operations by 25%-40% when the system clock frequency is 1 MHz or lower. The command sequences are identical to the standard commands.

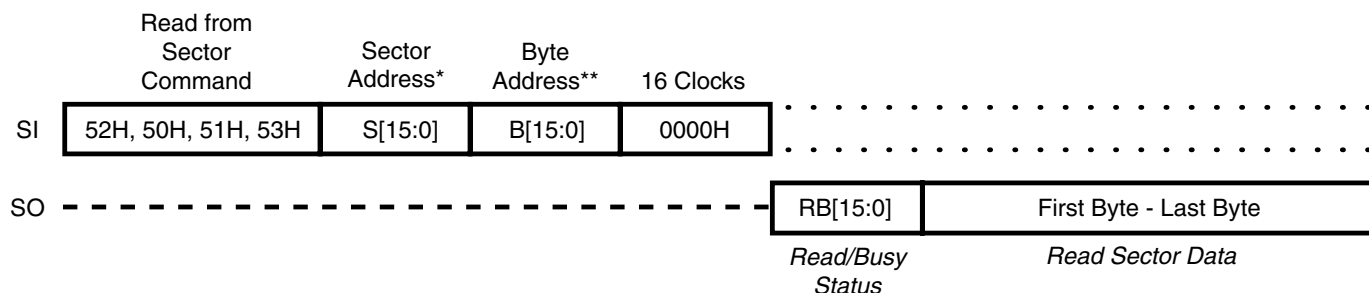

*The sector address only uses bits [8:0], [9:0] or [10:0] Depending on the density

**The byte address only uses bits [8:0]. Byte address must be 0000h for Auto Increment commands

Write Enable (06H)

Upon power-up, the Flash memory array is write-protected until the *Write Enable* command (06H) has been issued. The \overline{WP} pin must be inactive while writing the command for the write enable to be accepted. The status of the device's write protect state can be read in the status register. The *Write Enable* command sequence is completed by asserting \overline{CS} high after eight additional clocks.

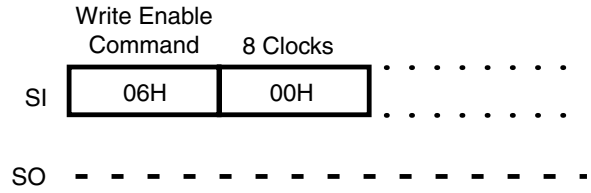

Write Disable (04H)

The *Write Disable* command (04H) protects the Flash memory array from being programmed. Once issued, further *Write to Sector* or *Transfer SRAM to Sector* commands will be ignored. The status of the write protect state can be read in the status register. The *Write Disable* command sequence is completed by asserting \overline{CS} high after eight additional clocks.

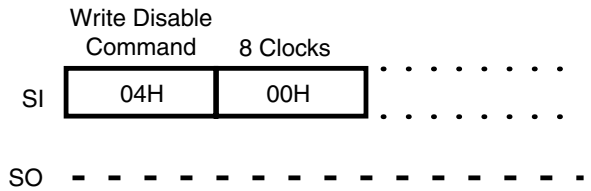

Write to Sector Through SRAM (F3H)

Before writing to a sector in the Flash memory array, all hardware and software write protection must be in an enabled state. This means that the \overline{WP} pin must be in a high state, a *Write Enable* command must have previously been issued, and the sector location that is to be written to must be outside the write protect range set in the configuration register. Additionally, the Ready/Busy status should be checked to confirm that the memory array is available to be written to.

Writing to a sector is accomplished by first bringing \overline{CS} low and shifting in the *Write to Sector* command (F3H) followed by a 16-bit “sector-address” field. Although the sector-address field is 16-bits, only bits S[8:0] for the NX25F011B (0-1FFH), S[9:0] for the NX25F021B (0-3FFH), or S[10:0] for the NX25F041B (0-7FFH) are used. The uppermost sector address bits are not used but must be clocked in (use 0 data). Following the sector address, a 16-bit “byte-address” field is clocked into the device to designate the starting location within the 264-byte sector. Only bits B[8:0] of the byte-address field are used and only values of 0-107H (264 bytes) are valid.

After the byte-address has been loaded, data is shifted into the 264-byte SRAM, which serves as a temporary storage buffer. Existing data in the SRAM will be written over. The byte order of the data shifted into the SRAM is least significant byte first (i.e., byte-00H, byte-01H,...). The bit order within each byte is most significant bit first (i.e., D7,...D0). The byte-address is automatically incremented to the next higher byte address as the clock continues. When the last byte address to be written is reached, the command can be completed with an additional eight control clocks (with data=0) followed by asserting \overline{CS} high. If the clock continues to increment past the highest byte-address (107H), the address counter will roll over to byte 0H.

After the \overline{CS} pin is brought high, the data in the SRAM is transferred to the specified sector in memory array. See t_{WP} timing specifications. During this time the array and SRAM will be “busy” and will ignore further array-related commands until complete. All Ready/Busy status indicators will indicate a busy status. Detailed clock timing for the *Write to Sector* command is shown in Figure 11.

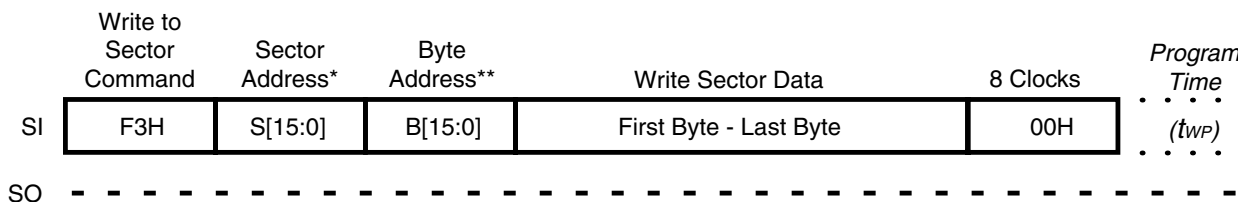

*The sector address only uses bits [8:0], [9:0] or [10:0]

**The byte address only uses bits [8:0]

SERIAL SRAM COMMANDS

Write to SRAM Command (72H)

The *Write to SRAM* command (72H) provides access to the 264-Byte SRAM independently of any Flash memory array operation. When \overline{CS} is asserted high to complete the command, the contents of the SRAM will be maintained until overwritten through another command or the power is removed. Using the *Write to SRAM* command,

data can be loaded in preparation of writing to a sector in memory and then transferred to a selected sector using the *Transfer SRAM to Sector* command. The TR bit in the status register should be checked first if *Transfer Sector to SRAM* or *Compare Sector to SRAM* commands are used.

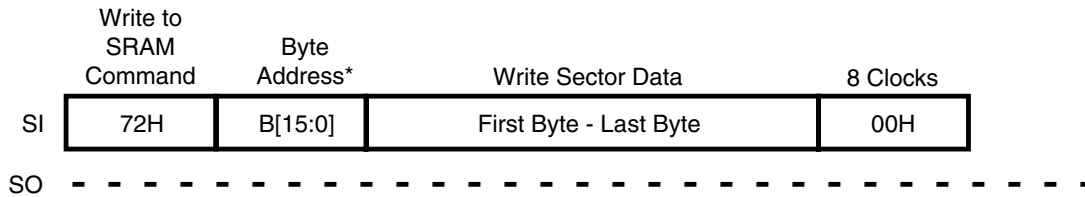

*The byte address only uses bits [8:0]

Read from SRAM (71H)

The *Read from SRAM* command (71H) provides access to the 264-Byte SRAM independent of any Flash memory array operations. The TR bit in the status register should be checked first if *Transfer Sector to SRAM* or *Compare Sector to SRAM* commands are used.

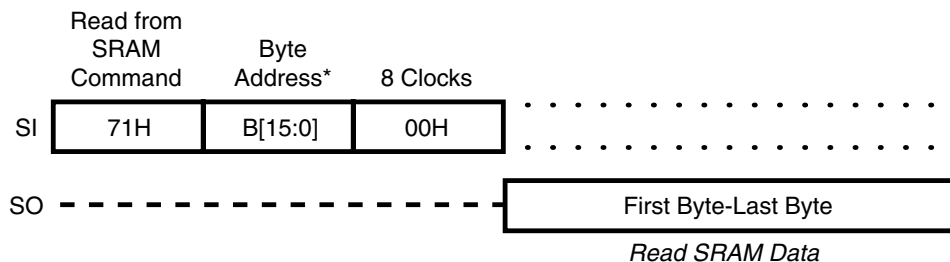

*The byte address only uses bits [8:0]

Transfer All of SRAM to Sector (F3H)

The *Transfer SRAM to Sector* command (F3H) will write the existing contents of the SRAM to the specified sector in memory. The command sequence is identical to that of the *Write to Sector* command except that immediately after the sector address field S[15:0] and 16 control clocks, the \overline{CS} pin is asserted high. This automatically transfers the 264-bytes of SRAM data to the specified sector in the memory array. During this time, the array will be busy. Since the entire 264-bytes are transferred, the byte-address field B[15:0] is not used.

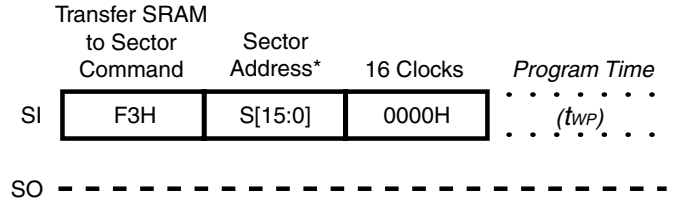

*The sector address only uses bits [8:0], [9:0] or [10:0] Depending on device density

Transfer All of Sector to SRAM (53H)

The *Transfer Sector to SRAM* command (53H) allows the contents of a sector to be transferred directly to the SRAM without having to clock or read the sector out of the device and rewrite it into the SRAM. During the transfer, the SO output is in a high-impedance state and the TR bit in the status register will be set to a "1" state. When the last byte address is transferred the TR bit in the status register will be cleared. Note that *the Transfer Sector to SRAM Clocked* command (54H) can also be used if partial transfers are required.

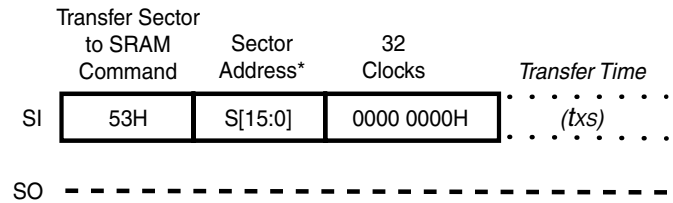

*The sector address only uses bits [8:0], [9:0] or [10:0] Depending on device density

Compare Sector to SRAM (8DH)

The *Compare Sector to SRAM* command (8DH) does a bit-by-bit comparison of the data stored in the addressed sector against data in the SRAM. The TR bit will be 1 during the transfer compare operation. If any of the compared bits are not equal, then the *Compare Not Equal (CNE)* bit in the Status Register is set to a 1. This bit will stay set until a *Clear*

Compare Status command has been issued. Note that the *Compare Sector to SRAM Clocked* command can be used if partial compares are required. This command is very useful for performing a fast verify of the Last Sector write operation. This verify provides for the highest data integrity.

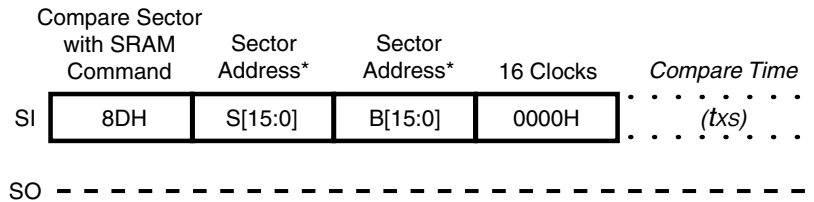

*The sector address only uses bits [8:0], [9:0] or [10:0]
 Depending on device density

CONFIGURATION AND STATUS COMMANDS

Read Configuration Register (8CH)

The *Read Configuration Register* command provides access to the configuration register, which stores the current configuration of the HOLD-R/B pin, read clock edge, write protect range, and alternate oscillator frequency (Figure 7). A 16-bit Configuration Data field CF[15:0] provides the contents of the Configuration Register. Although the field is 16-bits long, only bits CF[7:0] are used. All other upper bits are reserved for future features.

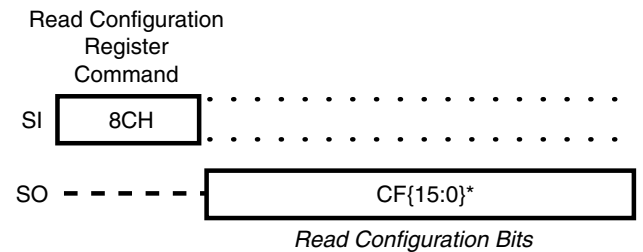

*The CF Register only uses bits [7:0]

Write Non-Volatile Configuration Register (8AH)

The *Write Configuration Register* command provides access to the configuration register which stores the current configuration of the $\overline{\text{HOLD-R/B}}$ pin, read-data clock edge, write protect range, and alternate oscillator frequency. The configuration register is non-volatile. Once set using the *Write Configuration Register* command, the contents will maintain even when power is removed. Because the register's state is stored in non-volatile memory, there is a finite endurance limit to the number of times it can be written to. To limit the number of writes, it is recommended that before writing to the configuration register it should first be read from using the *Read Configuration Register* command. If no change is required, the *Write Configuration Register* command can be skipped. This process will help

extend the endurance of the configuration register bits and eliminate additional programming "busy" time.

The *Write Configuration Register* command sequence starts with the command byte (8AH) followed by a 16-bit field that specifies configuration register bit settings. Although the field is 16-bits long, only bits CF[7:0] are used. All other upper bits are reserved and must be clocked using 0 for data. After an additional 16 control clocks using 0 for data, the command can be completed by asserting $\overline{\text{CS}}$ high. The device will become busy for a short time (t_{WP}) while the non-volatile memory cells of the configuration register are programmed.

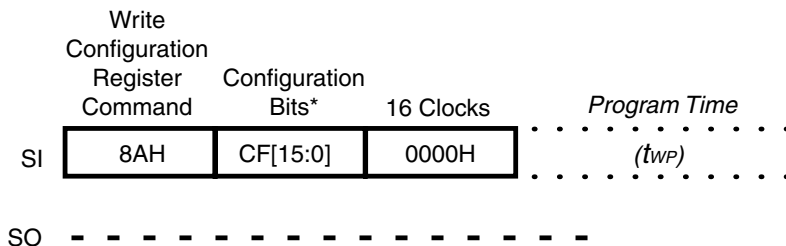

*The CF Register only uses bits [7:0]

Read Status Register (84H)

The *Read Status Register* command provides access to the status register and its status flags for Ready/Busy (R/B), SRAM and program buffer transfer operations (TX), Write Enable/Disable ($\overline{\text{WE}}$), and Compare Not Equal (CNE) (Figure 8). An 8-bit Status field ST[7:0] provides the contents of the Status Register.

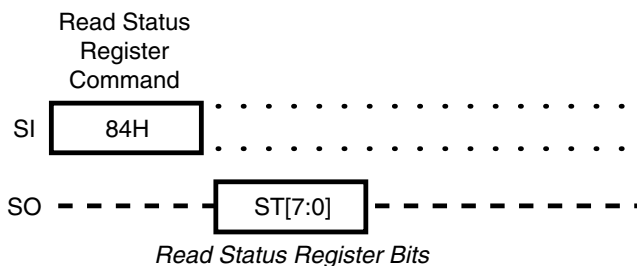

Clear Compare Status (89H)

The *Clear Compare Status* command (89H) works in conjunction with the *Compare Sector to SRAM* command and the Status Register. If any of the compared bits are not equal, then the Compare Not Equal (CNE) bit in the Status Register is set to a 1. The *Clear Compare Status* command must be executed to reset the CNE bit to a 0.

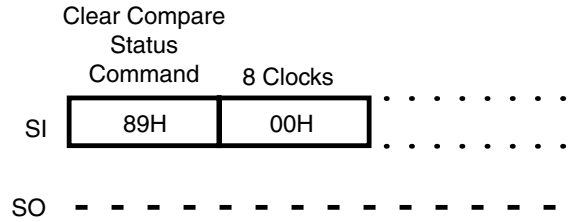

Set Power Detection Bit (03H)

The *Set Power Detection Bit* command (03H) can be used to detect if power has been removed from the device. The command works in conjunction with the Power Detect (PD) status bit. Upon power up the PD bit is cleared to 0. The PD bit can be set to a 1 using the *Set Power Detection Bit* command. Once set, if a power down condition occurs (V_{cc} voltage < 2V) the PD bit will reset to 0. This function is especially useful for applications using *NexFlash* Serial Flash Modules or other removable media.

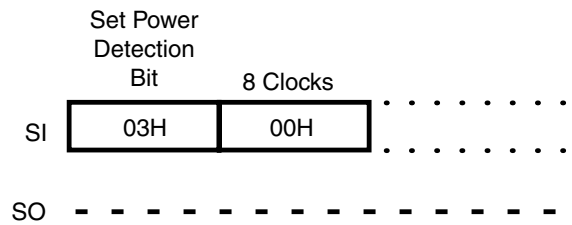

Reset Power Detection Bit (09H)

The *Reset Power Detection Bit* command (09H) can be used to force the Power Detect Status bit in the status register to a 0 state. (see Set Power Detection Bit command (03H).

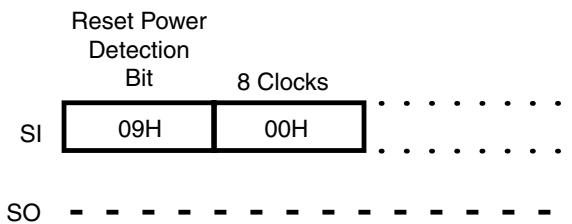

Read Device Information Sector (15H)

The *Read Device Information* command provides access to a read-only sector that can be used to electronically identify the *NexFlash* Serial Flash device being interfaced to. Information available includes: part number, density, voltage, temperature range, package type, and any special options. This can be extremely useful for systems that need to accommodate optional densities

(e.g., both 1M-bit or 2M-bit). In this case the firmware can interrogate the Device Information Sector and determine the density. The Device Information Sector also includes a list of any restricted sectors that might exist in the device. Contact *NexFlash* for more detailed information on the Device Information Sector format.

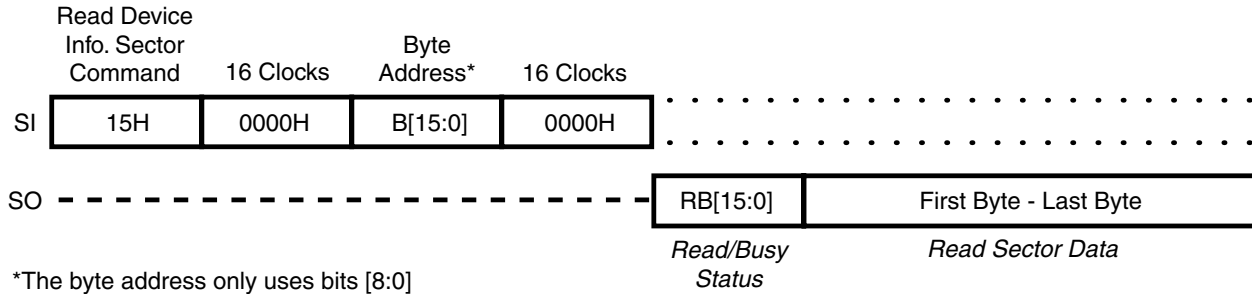

SPECIAL SECTOR COMMANDS

Erase Sector (F1H)

The *Erase Sector* command (F1H) will erase a sector to an "all 1s" state, during this time the array will be "busy." This command can be used in conjunction with the *Write only to Sector through SRAM* command (F2H) to achieve faster program performance in applications that can accommodate pre-erase. (see TEO in AC Characteristics for erase timing).

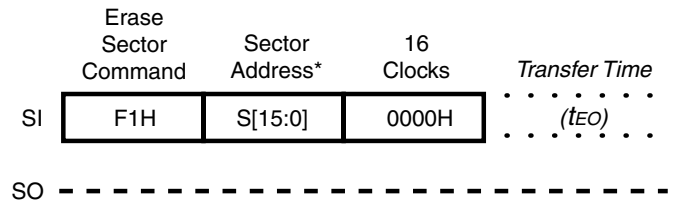

Erase Block (F4H)

The *Erase Block* command (F4H) will erase a block of 32 sectors to an "all 1s" state, during this time the array will be "busy." This command can be used in conjunction with the *Write only to Sector through SRAM* command (F2H) to achieve faster program performance in applications that can accommodate pre-erase. (see TEO in AC Characteristics for erase and write timing).

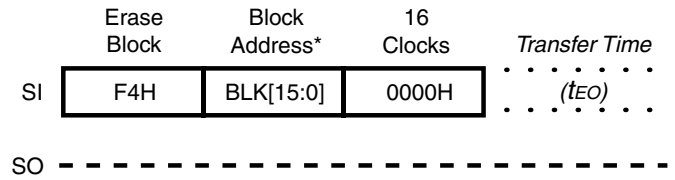

*The Block address only uses bits [8:5], [9:5] or [10:5] Depending on device density. Lowest four bit [4:0] must be 0h

Write-only to Sector (F2H)

The *Write-Only to Sector through SRAM* command (F2H) will write a pre-erased sector in about half the time of the standard *Write to Sector through SRAM* command (F3H), during this time the array will be "busy." This command can be used in conjunction with the *Erase Sector* command (F1H) or *Erase Block* command (F4H) to achieve

faster program performance in applications that can accommodate pre-erase. (see Two inAC Characteristics for erase and write timing). **Warning:** to ensure data integrity this command should only be issued after an erase command.

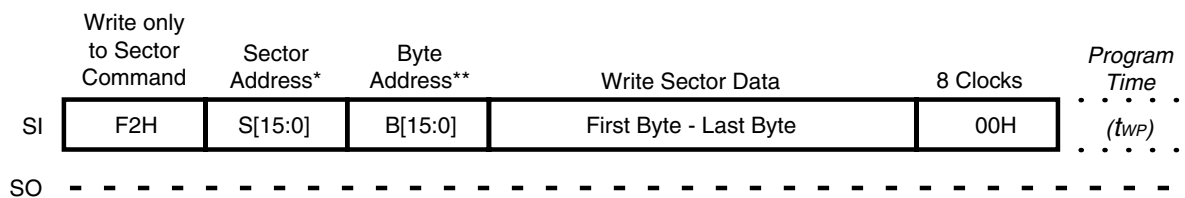

*The sector address only uses bits [8:0], [9:0] or [10:0] Depending on device density
 **The byte address only uses bits [8:0]

COMPATIBILITY COMMANDS FOR 25xxxA SERIES DEVICES

Read from SRAM (81H)

The *Read from SRAM* command (81H) provides access to the 264-Byte SRAM independent of any Flash memory array operations. The command is similar to the *Read from*

Sector command except for the sector address field S[15:0] which is replaced with all 0 bits.

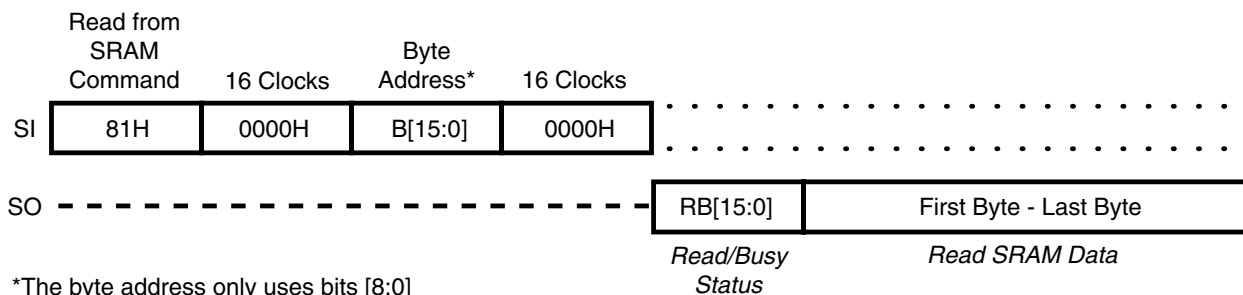

Write to SRAM (82H)

The *Write to SRAM* command (82H) provides access to the 264-Byte SRAM independently of any Flash memory array operation. The command is similar to the *Write to Sector* command sequence except that the sector address field S[15:0] is replaced by all 0 bits. When $\overline{\text{CS}}$ is asserted high to complete the command, the contents

of the SRAM will be maintained until overwritten through another command or the power is removed. Using the *Write to SRAM* command, data can be loaded in preparation of writing to a sector in memory and then transferred to a selected sector using the *Transfer SRAM to Sector* command.

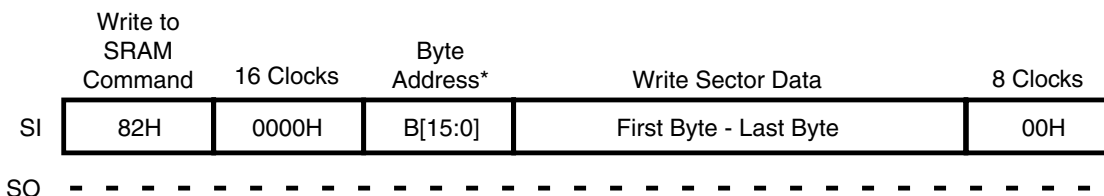

*The byte address only uses bits [8:0]

Read Configuration Register (8BH)

The *Read Configuration Register* command provides access to the configuration register, which stores the current configuration of the $\overline{\text{HOLD-R/B}}$ pin, read clock edge, write protect range, and alternate oscillator frequency (Figure 7). The command sequence is similar to the *Read from Sector* command except that the sector address field S[15:0] and the byte-address field B[15:0]

are replaced with all 0 bits. After 16 control clocks and after the Ready/Busy status field has been clocked through, a 16-bit Configuration Data field CF[15:0] provides the contents of the Configuration Register. Although the field is 16-bits long, only bits CF[7:0] are used. All other upper bits are reserved for future features.

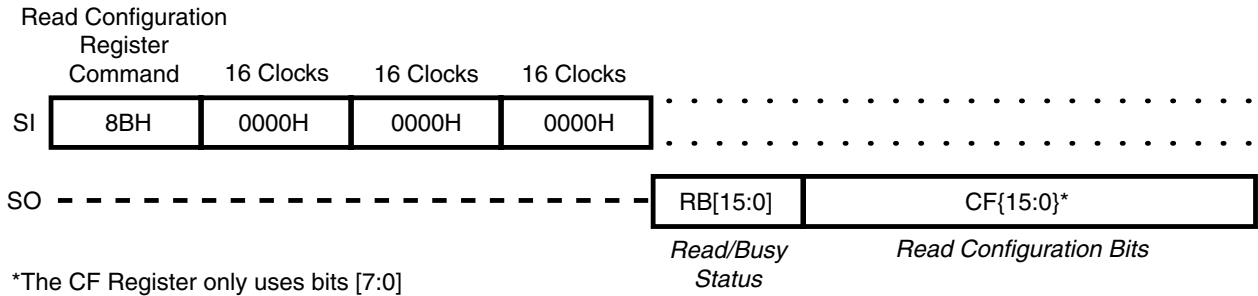

Read Status Register (83H)

The *Read Status Register* command provides access to the status register and its status flags for Ready/Busy (R/B), SRAM and program buffer transfer operations (TX), Write Enable/Disable ($\overline{\text{WE}}$), and Compare Not Equal (CNE) (Figure 8). The command sequence is similar to the *Read*

From Sector command except that the sector address field S[15:0] and the byte-address field B[15:0] are replaced by all 0 bits. After 16 clocks and the Ready/Busy status field RB[15:0] has been read, an 8-bit Status field ST[7:0] provides the contents of the Status Register.

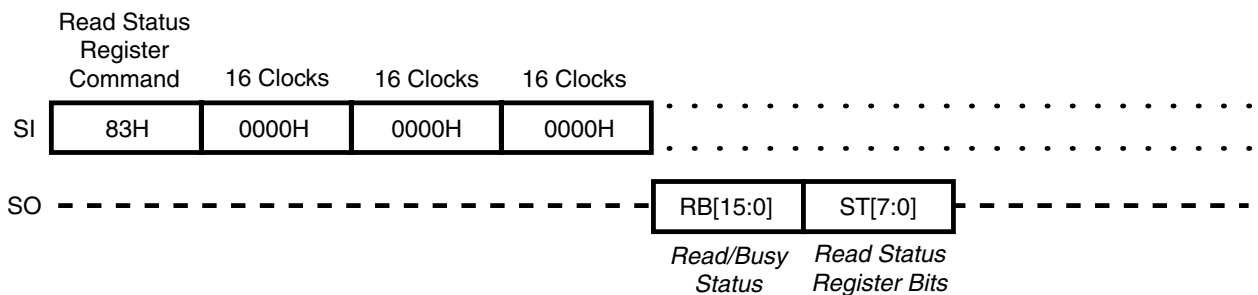

Transfer Sector to SRAM Clocked (54H)

The *Transfer Sector to SRAM Clocked* command (54H) allows the contents of a sector to be transferred directly to the SRAM without having to read the sector out of the device and rewrite it into the SRAM. The command is similar to the *Write to Sector* command except that instead of inputting data from the SI pin, the data is taken from the specified sector and is transferred to the SRAM. Every eight clocks on SCK, a byte from the specified sector to the SRAM will be transferred. Although data on SI is ignored, it is recom-

mended to write data bytes of 00H in order to support the clocking requirements. During the transfer, the SO output is in a high-impedance state. When the last byte address is transferred, the command can be completed by issuing eight more control clocks and asserting \overline{CS} high. If the clock continues to increment past the highest byte-address (107H), the address counter will roll over to byte-0H. This command can also be used to load partial sectors into SRAM

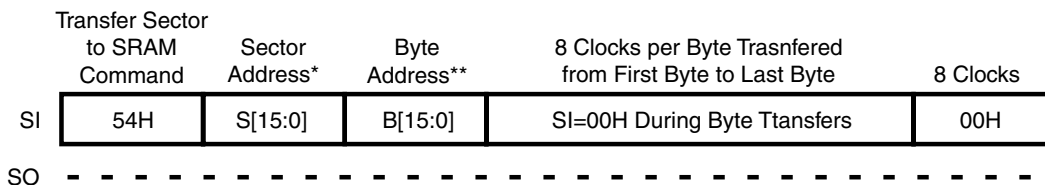

*The sector address only uses bits [8:0], [9:0] or [10:0] Depending on device density

**The byte address only uses bits [8:0]

Compare Sector to SRAM Clocked (86H)

The *Compare Sector to SRAM* command does a bit-by-bit comparison of the data stored in the addressed sector against data in the SRAM. The command is similar to the *Read from Sector* command except that data is not read out of the Serial Output pin (SO). Instead, the SO pin provides a bit-by-bit compare of each sector and SRAM bit. A high (1) per bit will be output if the bit compare is equal. A low (0) per bit will be output if the bit compare is not equal. The compare can start from any location in the 264-byte range as

specified by the byte-address field B[15:0]. The byte-address counter is automatically incremented and will wrap around to the first address (0H) if it passes the last address (107H). If any of the compared bits are not equal, then the *Compare Not Equal* (CNE) bit in the Status Register is set to a 1. This bit will stay set until a *Clear Compare Status* command has been issued. This command can also be used to load partial sectors into SRAM

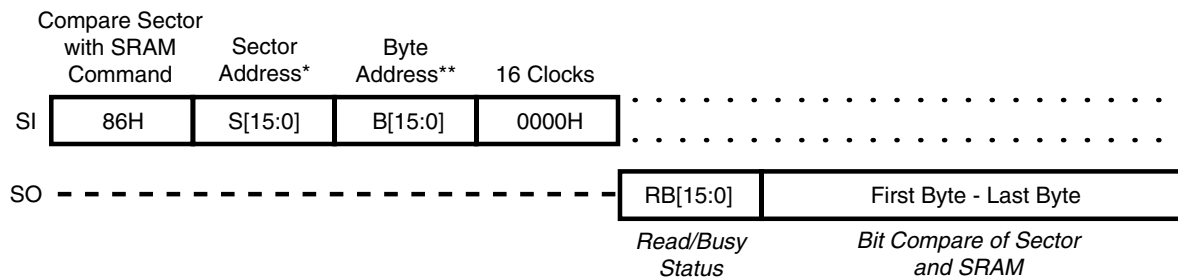

*The sector address only uses bits [8:0], [9:0] or [10:0] Depending on device density

**The byte address only uses bits [8:0]

Sector Format

The memory array of standard Serial Flash devices are factory programmed to a full erase state with all bits set to “1” (FFH). NexFlash also offers restricted sector devices (with “-R” suffix) which may provide a more cost effective alternative to standard devices that have 100% valid sectors. Restricted sector devices have a limited number of sectors that do not meet manufacturing programming criteria over the specified operating range. The first byte of each good sector in a “-R” device is pre-programmed during manufacturing with a tag/sync value of C9H. Although this byte location of the sector can be changed, it is recommended that it be maintained and incorporated into the application’s sector formatting. The tag/sync values serve two purposes. First, they provide a sync-detect that can help verify if the command sequence was clocked into the device properly. Secondly, they serve as a tag to identify a fully functional (valid) sector. For defective sectors, the first byte is tagged with a pattern other than C9H. In addition to individual sector tagging, all restricted sectors for a given device are listed in the Device Information Sector. For more information see the latest version of Device Information Sector Application Note SFAN-02.

High Data Integrity Applications

Data storage applications that use Flash memory or other non-volatile media must take into consideration the possibility of noise or other adverse system conditions that may affect data integrity. For those applications that require higher levels of data integrity it is a recommended practice to use Error Correcting Code (ECC) techniques. The NexFlash Serial Flash Development Kit provides a software routine for a 32-bit ECC that can detect up to two bit errors and correct one. The ECC not only minimizes problems caused by system noise but can also extend Flash memory endurance.

Write/Verify Flow

For those systems without the processing power to handle ECC algorithms, a simple “verification after write” is recommended. The write verify can be done quickly (less than txs) using the Compare Sector command. The compare result can be checked in the Status Register. If compare is not equal (CNE=1) then a sector rewrite should be done using the Transfer to Sector command (Figure 12). A single retry is adequate for most applications. However, if an application requires extended endurance additional retries can be added. The Serial Flash Development Kit software includes a simple Write/Verify routine that will compare data written to a given sector and rewrite the sector if the compare is not correct.

Grouping Static and Frequently Updated Data

In the NX25F011B/021B/041B a data block is every 32 sectors starting from sector 0; that is, block 0 is sector 0 - 31, block 1 is sector 32 - 63 and so on. Refer to figure 4. For the highest data integrity, it is important to separate static data (configuration settings, tables) and frequently updated data (streaming voice/image or data acquisition) into separate blocks. Following this convention optimizes the environment for the data stored in the flash cells within each block.

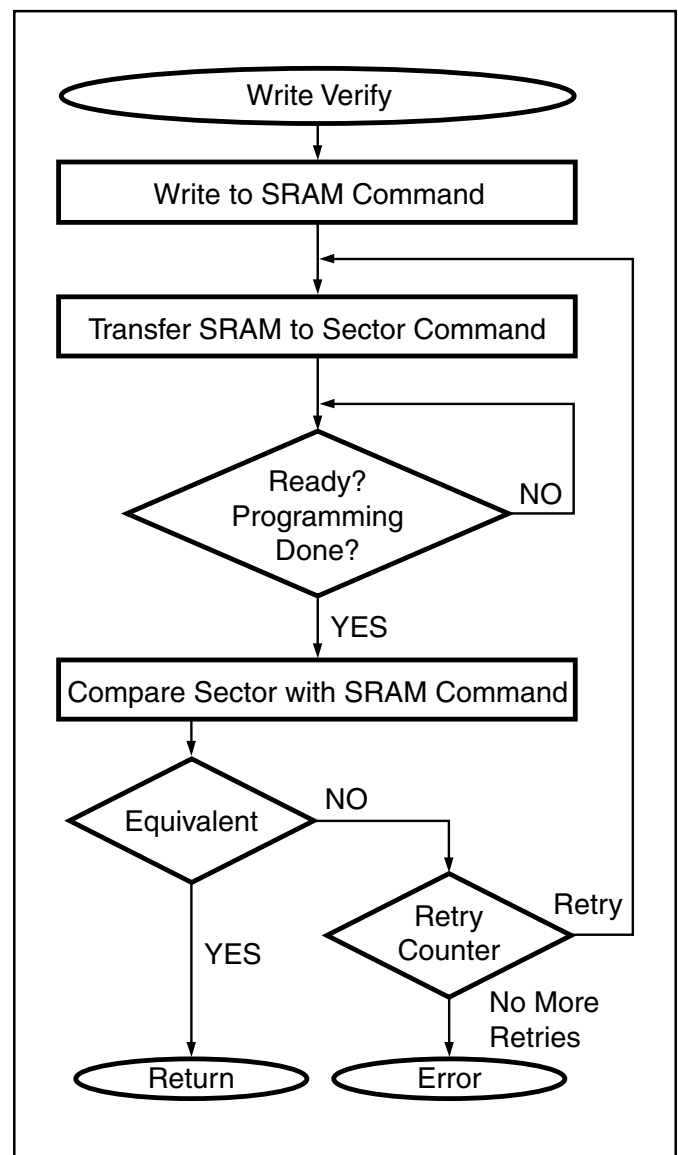

Figure 12. Write/Verify Flow

ABSOLUTE MINIMUM RATINGS ⁽¹⁾

| Symbol | Parameters | Conditions | Range | Unit |
|------------------------------------|----------------------------|----------------------|-------------------------------|------|
| V _{CC} | Supply Voltage | | 0 to 7.0 | V |
| V _{IN} , V _{OUT} | Voltage Applied to Any Pin | Relative to Ground | -0.5 to V _{CC} + 0.5 | V |
| T _{STG} | Storage Temperature | | -65 to +150 | °C |
| T _{LEAD} | Lead Temperature | Soldering 10 Seconds | +300 | °C |

Note:
 1. This device has been designed and tested for the specified operation ranges. Proper operation outside of these levels is not guaranteed. Exposure beyond absolute maximum ratings (listed above) may cause permanent damage.

OPERATING RANGES

| Symbol | Parameter | Conditions | Min | Max | Unit |
|-------------------|--------------------------------|---|-----------------|-------------------|----------------|
| V _{CC} | Supply Voltage ⁽¹⁾ | 5.0V programming 3.0V or 3.3 V programming | 4.5 2.7 | 5.5 3.6 | V V |
| T _A | Ambient Temperature, Operating | Commercial Extended Industrial | 0 -20 -40 | +70 +70 +85 | °C °C °C |
| T _{RVCC} | Power Ramp Time | | — | 10 | ms |

Note:
 1. V_{CC} voltage during Read can operate across the min and max range but should not exceed ±10% of the programming (erase/write) voltage.

DC ELECTRICAL CHARACTERISTICS (Preliminary) ⁽²⁾

| Symbol | Parameter | Conditions | Min | Typ | Max | Unit |
|--------------------------------------|--|--|----------------------|----------|----------------------|----------|
| V _{IL} | Input Low Voltage | | -0.4 | — | V _{CC} ×0.2 | V |
| V _{IH} | Input High Voltage | | V _{CC} ×0.6 | — | V _{CC} +0.5 | V |
| V _{OL} | Output Low Voltage | I _{OL} = 2 mA V _{CC} = 4.5V | — | — | 0.45 | V |
| V _{OH} | Output High Voltage | I _{OH} = -400 μA V _{CC} = 4.5V | 2.4 | — | — | V |
| V _{OLC} | Output Low Voltage CMOS | V _{CC} = Min, I _{OL} = 10 μA | — | — | 0.15 | V |
| V _{OHc} | Output High Voltage CMOS | V _{CC} = Min, I _{OH} = -10 μA | V _{CC} -0.3 | — | — | V |
| I _{IL} | Input Leakage | 0 < V _{IN} < V _{CC} | -10 | — | +10 | μA |
| I _{OL} | I/O Leakage | 0 < V _{IN} < V _{CC} | -10 | — | +10 | μA |
| I _{CC} (active) | Active Power Supply Current | f _{CLK} @ 8 MHz (1/tCP) V _{CC} = 5V V _{CC} = 3V | 5 2 | 6 2.5 | 8 4 | mA mA |
| I _{CCLF} (low frequency) | Active Current Low Frequency. Read | f _{CLK} @ 1 MHz (1/tCP) V _{CC} = 5V V _{CC} = 3V | 2 1 | 4 1.5 | 5 2 | mA mA |
| I _{CCSB} (standby) | Standby V _{CC} Supply Current | CS = V _{CC} , V _{IN} = V _{CC} or 0 V _{CC} = 5V V _{CC} = 3V | — — | 5 1 | 10 5 | μA μA |
| C _{IN} | Input Capacitance ⁽¹⁾ | T _A = 25°C, V _{CC} = 5V or 3V Frequency = 1 MHz | — | — | 10 | pF |
| C _{OUT} | Output Capacitance ⁽¹⁾ | T _A = 25°C, V _{CC} = 5V or 3V Frequency = 1 MHz | — | — | 10 | pF |

Notes:
 1. Tested on a sample basis or specified through design or characterization data.
 2. See Preliminary Designation page 31

AC ELECTRICAL CHARACTERISTICS (Preliminary) (4)

| Symbol | Description | | Fast SPI (RCE=1) | | | Standard SPI (RCE = 0) | | | Unit |
|--------|--|----------|---------------------|-----|-----|---------------------------|-----|-----|------|
| | | | Min | Typ | Max | Min | Typ | Max | |
| FREQ | Clock Frequency | Vcc = 5V | 0 | — | 20 | 0 | — | 12 | MHz |
| | | Vcc = 3V | 0 | — | 20 | 0 | — | 10 | MHz |
| tcyc | SCK Serial Clock Period (1) | Vcc = 5V | 50 | — | — | 80 | — | — | ns |
| | | Vcc = 3V | 50 | — | — | 100 | — | — | ns |
| tWH | SCK Serial Clock High or Low Time | | 24 | — | — | 24 | — | — | ns |
| tWL | | | | | | | | | |
| trI | SCK Serial Clock Rise or Fall Time (2) | | — | — | 5 | — | — | 5 | ns |
| tFI | | | | | | | | | |
| tsu | Data Input Setup Time to SCLK | Vcc = 5V | 14 | — | — | 14 | — | — | ns |
| | | Vcc = 3V | 25 | — | — | 25 | — | — | ns |
| tIH | Data Input Hold Time from SCLK | | 0 | — | — | 0 | — | — | ns |
| toH | Data Output Hold Time from SCLK | | 0 | — | — | 0 | — | — | ns |
| tv | Data Output Valid after SCLK (1,3) | Vcc = 5V | — | — | 35 | — | — | 35 | ns |
| | | Vcc = 3V | — | — | 45 | — | — | 45 | ns |
| tcSS | $\overline{\text{CS}}$ Setup Time to Command | | 100 | — | — | 100 | — | — | ns |
| tcSH | $\overline{\text{CS}}$ Hold Time after Command | | 100 | — | — | 100 | — | — | ns |
| tWP | Erase/Write Program Time (see Write to Sector Command) | | — | 7.5 | 20 | — | 7.5 | 20 | ms |
| tEO | Erase Only Time (see Erase Sector/Block Commands) | | — | 2 | 4 | — | 2 | 4 | ms |
| tWO | Write Only Time (see Write Only to Sector Command) | | — | 5.5 | 16 | — | 5.5 | 16 | ms |
| txS | Transfer or Compare Sector (see Transfer/Compare All Command) | | — | 100 | 150 | — | 100 | 150 | μs |
| tHD | SCK Setup Time to $\overline{\text{HOLD}}$ | | 10 | — | — | 10 | — | — | ns |
| tCD | SCK Hold Time from $\overline{\text{HOLD}}$ | | 30 | — | — | 30 | — | — | ns |
| tCS | $\overline{\text{CS}}$ Deselect Time | | 160 | — | — | 160 | — | — | ns |
| tRB | READY / BUSY Valid Time | | 160 | — | — | 160 | — | — | ns |
| tDIS | Data Output Disable Time | | — | — | 60 | — | — | 60 | ns |
| tHZ | Data Disable/Enable from $\overline{\text{HOLD}}$ | | — | — | 60 | — | — | 60 | ns |

Notes:

1. To achieve maximum clock performance, the read clock edge will need to be set for rising edge operation in the configuration register (RCE=1).
2. Test points are 10% and 90% points for rise/fall times. All others timings are measured at 50% point.
3. With 30 pF (16 MHz) load SO to GND.
4. See Preliminary Designation page 31

SERIAL OUTPUT TIMING

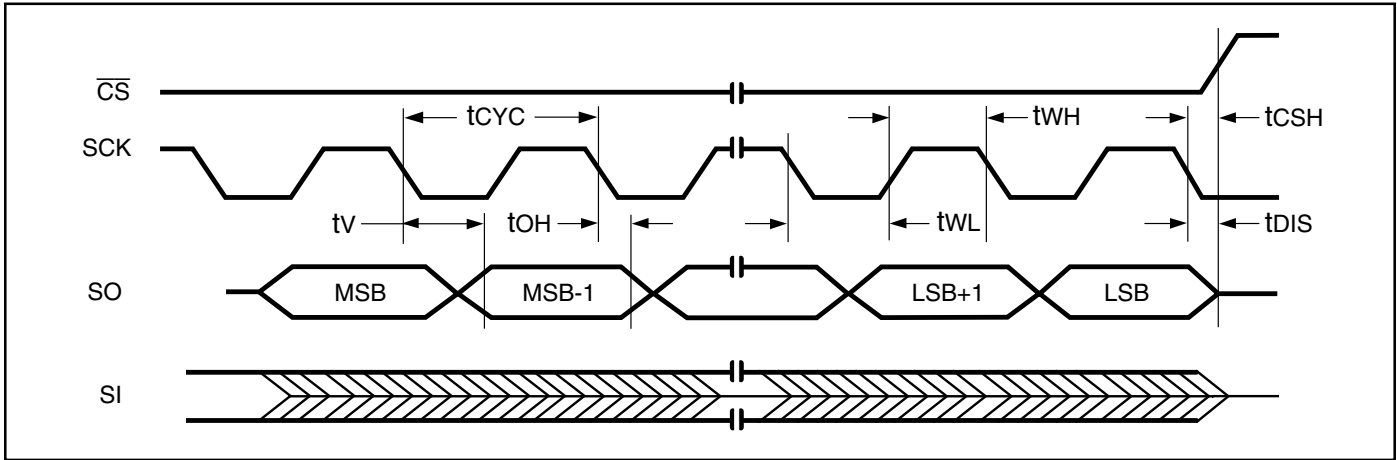

SERIAL INPUT TIMING

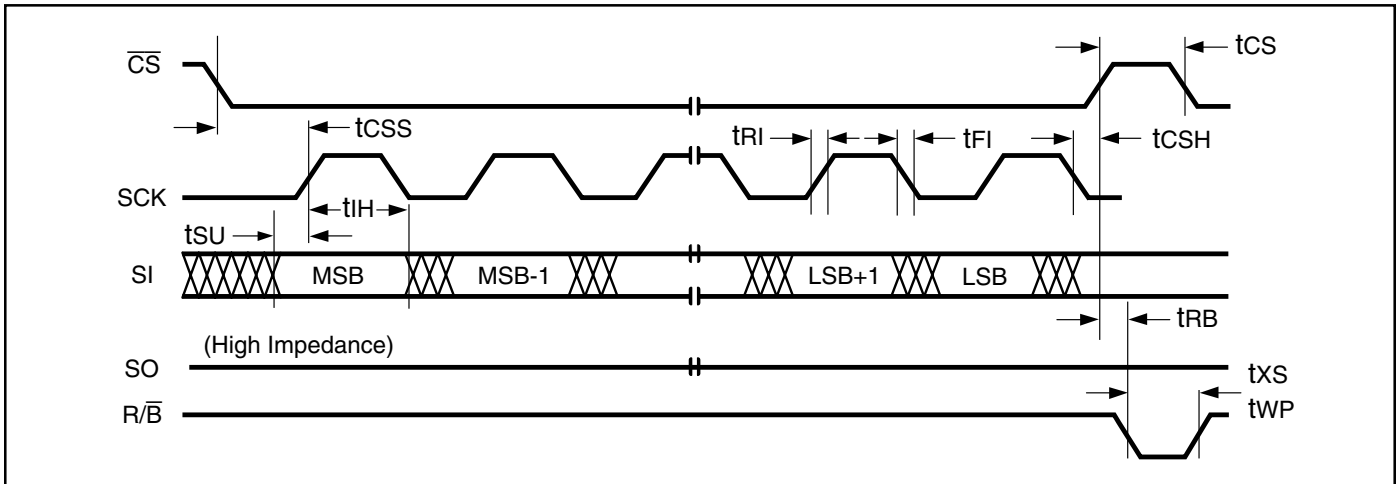

HOLD TIMING

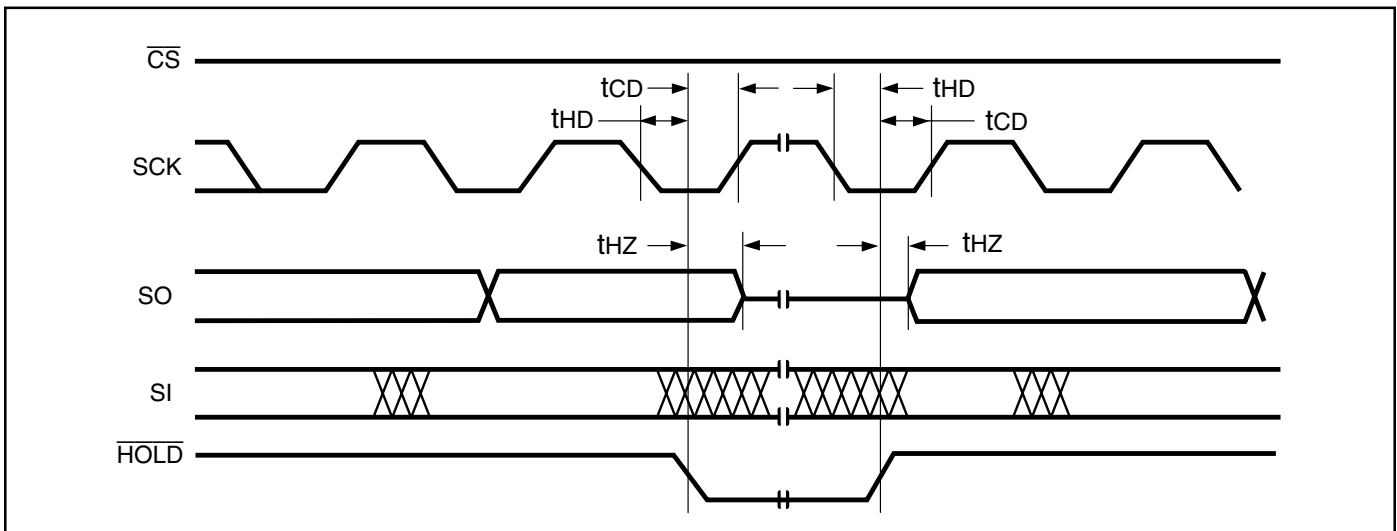

PACKAGING INFORMATION

200-mil Plastic SOIC
 Package Code: (S)

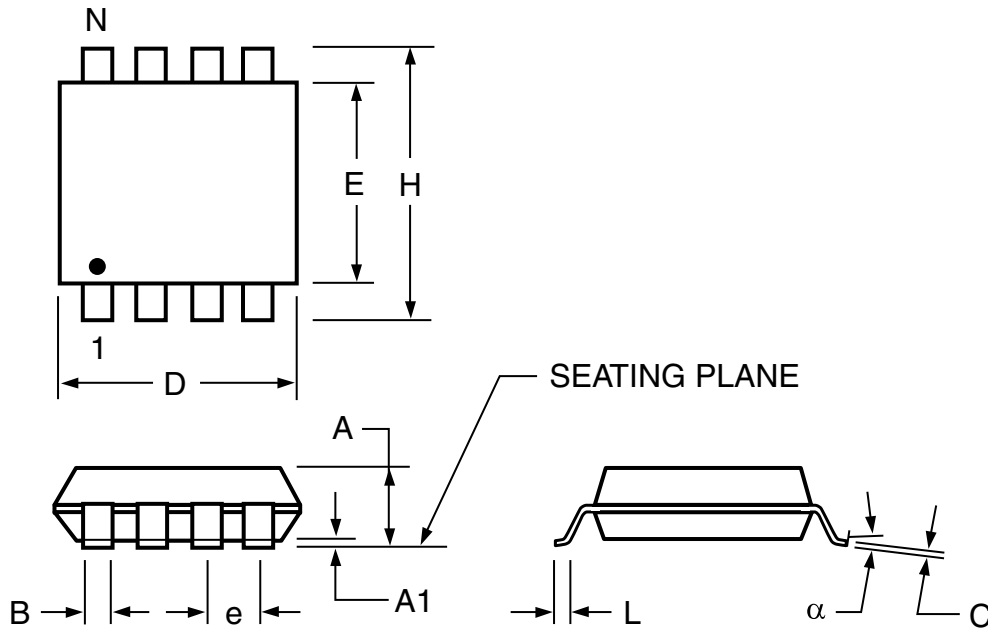

| 200 mil Plastic SOIC (S) | | | | |
|--------------------------|-------------|-------|-----------|-------|
| Symbol | Millimeters | | Inches | |
| | Min | Max | Min | Max |
| No. Leads | 8 | | | |
| A | 1.780 | 2.030 | 0.070 | 0.080 |
| A1 | 0.102 | 0.330 | 0.004 | 0.013 |
| B | 0.305 | 0.508 | 0.012 | 0.020 |
| C | 0.178 | 0.254 | 0.007 | 0.010 |
| D | 5.160 | 5.380 | 0.203 | 0.212 |
| E | 5.210 | 5.410 | 0.205 | 0.213 |
| e | 1.27BSC | | 0.050 BSC | |
| H | 7.62 | 8.38 | 0.300 | 0.330 |
| L | 0.508 | 0.889 | 0.020 | 0.035 |
| α | 0° | 8° | 0° | 8° |

Notes:

1. Controlling dimensions: inches, unless otherwise specified.
2. BSC = Basic lead spacing between centers.
3. Dimensions D and E1 do not include mold flash protrusions and should be measured from the bottom of the package.
4. Formed leads shall be planar with respect to one another within .0004 inches at the seating plane.

PACKAGING INFORMATION

330 mil Plastic SOIC
 Package Code: (J)

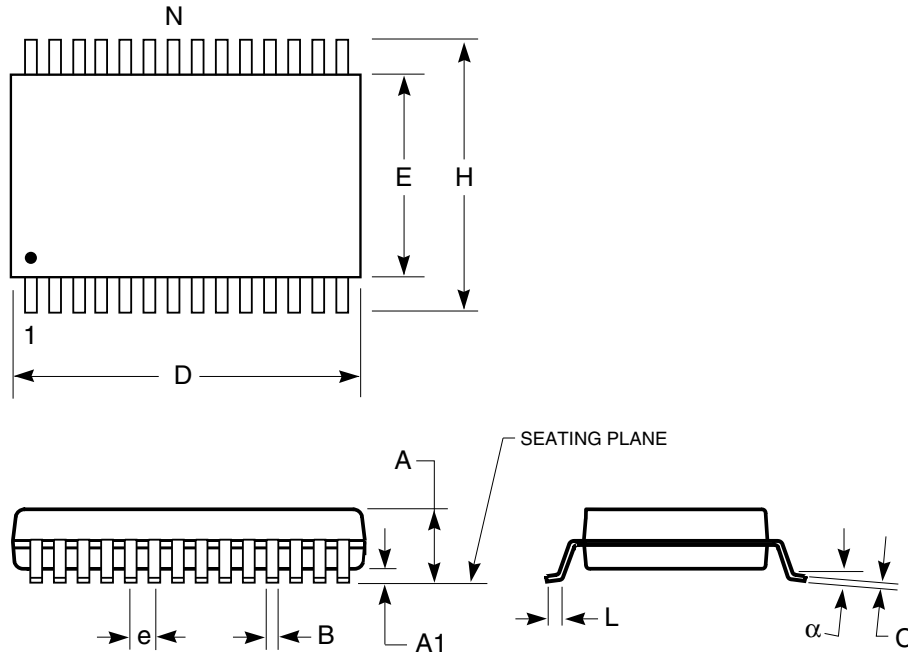

| 330 Mil Plastic SOIC (J) | | | | |
|--------------------------|-------------|-------|-----------|--------|
| Symbol | Millimeters | | Inches | |
| | Min | Max | Min | Max |
| Ref. Std. | | | | |
| No. Leads | 28 | | | |
| A | 2.388 | 2.794 | 0.094 | 0.110 |
| A1 | 0.051 | 0.508 | 0.002 | 0.020 |
| B | 0.051 | 0.356 | 0.002 | 0.014 |
| C | 0.203 | 0.305 | 0.008 | 0.0012 |
| D | 7.983 | 8.288 | 0.709 | 0.720 |
| E | 8.585 | 8.788 | 0.338 | 0.346 |
| H | 11.68 | 12.19 | 0.460 | 0.480 |
| e | 1.27 BSC | | 0.050 BSC | |
| L | 0.762 | 1.270 | 0.030 | 0.050 |
| a | 0° | 8° | 0° | 8° |

Notes:

1. Controlling dimension: inches, unless otherwise specified.
2. BSC = Basic lead spacing between centers.
3. Dimensions D and E do not include mold flash protrusions and should be measured from the bottom of the package.
4. Formed leads shall be planar with respect to one another within 0.004 inches at the seating plane.

PACKAGING INFORMATION

Plastic TSOP - 28-pins
 Package Code: Type I (V)

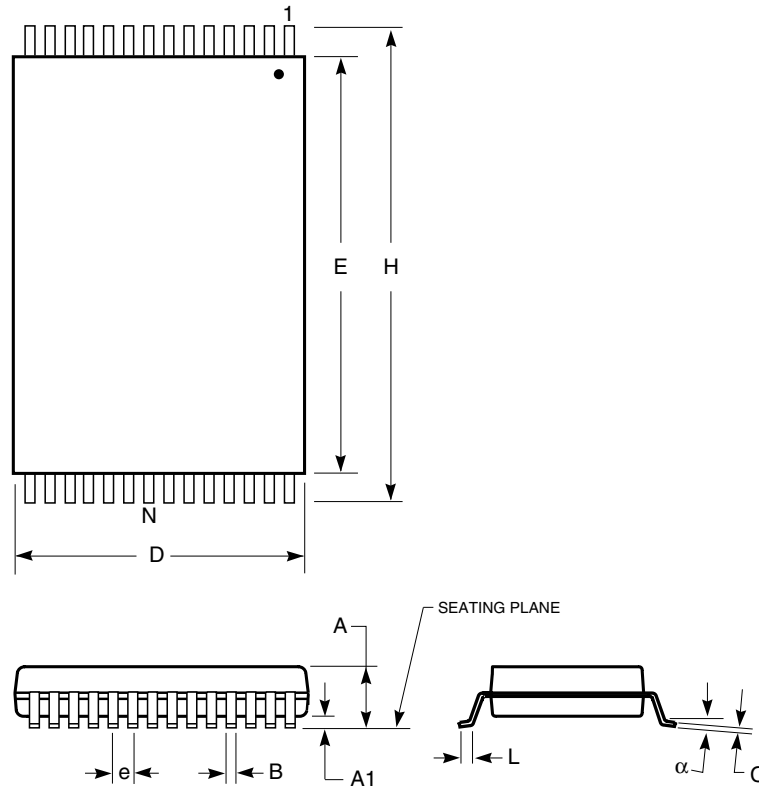

| Plastic TSOP Type I (V) | | | | |
|-------------------------|-------------|-------|-----------|-------|
| Symbol | Millimeters | | Inches | |
| | Min | Max | Min | Max |
| No. Leads | 28 | | | |
| A | 1.00 | 1.20 | 0.039 | 0.047 |
| A1 | 0.05 | 0.20 | 0.002 | 0.008 |
| B | 0.15 | 0.25 | 0.006 | 0.010 |
| C | 0.10 | 0.20 | 0.004 | 0.008 |
| D | 7.90 | 8.10 | 0.311 | 0.319 |
| E | 11.60 | 11.80 | 0.457 | 0.465 |
| H | 13.30 | 13.50 | 0.524 | 0.531 |
| e | 0.55 BSC | | 0.022 BSC | |
| L | 0.50 | 0.70 | 0.020 | 0.028 |
| α | 0° | 5° | 0° | 5° |

Notes:

1. Controlling dimension: millimeters, unless otherwise specified.
2. BSC = Basic lead spacing between centers.
3. Dimensions D and E do not include mold flash protrusions and should be measured from the bottom of the package.
4. Formed leads shall be planar with respect to one another within 0.004 inches at the seating plane.

PRELIMINARY DESIGNATION

The “Preliminary” designation on an *NexFlash* data sheet indicates that the product is not fully characterized. The specifications are subject to change and are not guaranteed. *NexFlash* or an authorized sales representative should be consulted for current information before using this product.

IMPORTANT NOTICE

NexFlash reserves the right to make changes to the products contained in this publication in order to improve design, performance or reliability. *NexFlash* assumes no responsibility for the use of any circuits described herein, conveys no license under any patent or other right, and makes no representation that the circuits are free of patent infringement. Charts and schedules contained herein reflect representative operating parameters, and may vary depending upon a user’s specific application. While the information in this publication has been carefully checked, *NexFlash* shall not be liable for any damages arising as a result of any error or omission.

LIFE SUPPORT POLICY

NexFlash does not recommend the use of any of its products in life support applications where the failure or malfunction of the product can reasonably be expected to cause failure in the life support system or to significantly affect its safety or effectiveness. Products are not authorized for use in such applications unless *NexFlash* receives written assurances, to its satisfaction, that:

- (a) the risk of injury or damage has been minimized;
- (b) the user assumes all such risks; and
- (c) potential liability of *NexFlash* is adequately protected under the circumstances.

Trademarks:

NexFlash is a trademark of *NexFlash Technologies, Inc.* All other marks are the property of their respective owner.

ORDERING INFORMATION

| Size | Order Part No. | Package |
|--------|----------------|-------------------------------|
| 1M-bit | NX25F011B-3V* | SPI, 28-pin, TSOP (Type I)3V |
| 1M-bit | NX25F011B-3S* | SPI, 8-pin, SOIC 3V |
| 1M-bit | NX25F011B-5V* | SPI, 28-pin, TSOP (Type I) 5V |
| 1M-bit | NX25F011B-5S* | SPI, 8-pin, SOIC 5V |
| 2M-bit | NX25F021B-3V* | SPI, 28-pin, TSOP (Type I) 3V |
| 2M-bit | NX25F021B-3S* | SPI, 8-pin, SOIC 3V |
| 2M-bit | NX25F021B-5V* | SPI, 28-pin, TSOP (Type I) 5V |
| 2M-bit | NX25F021B-5S* | SPI, 8-pin, SOIC 5V |
| 4M-bit | NX25F041B-3V* | SPI, 28-pin, TSOP (Type I) 3V |
| 4M-bit | NX25F041B-3J | SPI, 28-pin, SOIC 3V |
| 4M-bit | NX25F041B-5V* | SPI, 28-pin, TSOP (Type I) 5V |
| 4M-bit | NX25F041B-5J | SPI, 28-pin, SOIC 5V |

***Note:**

Add -R for Restricted Sector Device (See Serial Flash Application Note SFAN-2 for more information on restricted sector devices).



2711 North First Street • San Jose, CA 95134
Ph: 408-907-3600 • Fx: 408-907-3601 • sales@nexflash.com
www.nexflash.com