

# NEC's CW InGaAsP MQW DFB LASER DIODE MODULE FOR DWDM APPLICATIONS (10 mW MIN)

## NX8563 SERIES

### FEATURES

- **OUTPUT POWER:**  
P<sub>f</sub> = 10 mW MIN
- **INTERNAL THERMOELECTRIC COOLER AND ISOLATOR**
- **HERMETICALLY SEALED 14-PIN BUTTERFLY PACKAGE**
- **POLARIZATION MAINTAIN FIBER PIGTAIL**
- **AVAILABLE FOR DWDM WAVELENGTHS BASED ON ITU-T RECOMMENDATIONS (100 GHz GRID) REFER TO THE ORDERING INFORMATION**

### DESCRIPTION

NEC's NX8563 Series are a 1550 nm Multiple Quantum Well (MQW) structured Distributed Feed-Back (DFB) laser diode with Polarization Maintain Fiber (PMF). This device is designed as Continuous Wave (CW) light source and ideal for optical transmission systems in which external modulators are used.

This device is available for Dense Wavelength Division Multiplexing (DWDM) wave lengths based on ITU-T recommendations, enabling a wide range of applications.

### ELECTRO-OPTICAL CHARACTERISTICS (T<sub>LD</sub> = T<sub>SET</sub>, T<sub>C</sub> = -20 to +70°C)

| PART NUMBER      |  |       | NX8563 Series |                    |         |
|------------------|--|-------|---------------|--------------------|---------|
| SYMBOLS          | PARAMETERS AND CONDITIONS  | UNITS | MIN           | TYP                | MAX     |
| T <sub>SET</sub> | Laser Set Temperature  | °C    | 20            |                    | 35      |
| V <sub>F</sub>   | Forward Voltage, P <sub>f</sub> = 10 mW  | V     |               | 1.2                | 1.5     |
| I <sub>F</sub>   | Forward Current, P <sub>f</sub> = 10 mW  | mA    |               | 70                 | 125     |
| I <sub>TH</sub>  | Threshold Current  | mA    |               | 20                 | 40      |
| P <sub>f</sub>   | Optical Output Power from Fiber, I <sub>F</sub> = 125 mA, T <sub>LD</sub> = T <sub>SET</sub>           | mW    | 10            |                    |         |
| λ <sub>p</sub>   | Peak Emission Wavelength <sup>1</sup> , P <sub>f</sub> = 10 mW, CW, T <sub>LD</sub> = T <sub>SET</sub> | nm    | 1527.99       | ITU-T <sup>1</sup> | 1611.78 |
| Δν               | Spectral Line Width, P <sub>f</sub> = 10 mW, CW, 3 dB down   | MHz   |               | 1                  | 2       |
| SMSR             | Side Mode Suppression Ratio, P <sub>f</sub> = 10 mW, CW  | dB    | 33            | 45                 |         |
| RIN              | Relative Intensity Noise, P <sub>f</sub> = 10 mW, 20 MHz to 3 GHz                                      | dB/Hz |               |                    | -150    |
| ext              | Polarization Extinction Ratio <sup>2</sup> , P <sub>f</sub> = 10 mW, CW                                | dB    | 20            |                    |         |

Notes:

1. Available for DWDM based on ITU-T recommendations. Please refer to Ordering Information.
2. Polarization state of LD is aligned parallel to the slow axis.

**ELECTRO-OPTICAL CHARACTERISTICS** (Applicable to Monitor PD: TLD = TSET, Tc = -20 to +70°C)

| PART NUMBER    |   |       | NX8563 Series |     |      |
|----------------|---|-------|---------------|-----|------|
| SYMBOLS        | PARAMETERS AND CONDITIONS                                     | UNITS | MIN           | TYP | MAX  |
| I <sub>m</sub> | Monitor Current, P <sub>f</sub> = 10 mW, V <sub>R</sub> = 5 V | μA    | 100           |     | 2000 |
| I <sub>D</sub> | Dark Current, V <sub>R</sub> = 5 V                            | nA    |               |     | 10   |
| γ <sup>1</sup> | Tracking Error, I <sub>m</sub> = const.                       | dB    |               |     | 0.5  |

Note:  
 1.  $\gamma = \left| 10 \log \frac{P_f}{10 \text{ mW}} \right|$

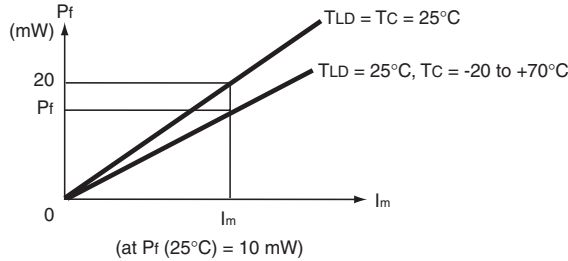

**ELECTRO-OPTICAL CHARACTERISTICS** (Applicable to Thermistor and TEC: TLD = TSET, Tc = -20 to +70°C)

| PART NUMBER    |   |       | NX8563 Series |      |      |
|----------------|---|-------|---------------|------|------|
| SYMBOLS        | PARAMETERS AND CONDITIONS   | UNITS | MIN           | TYP  | MAX  |
| R              | Thermistor Resistance, TLD = 25°C                                   | kΩ    | 9.5           | 10.0 | 10.5 |
| B              | B Constant  | K     | 3350          | 3450 | 3550 |
| I <sub>c</sub> | Cooler Current, ΔT = 70 - T <sub>set</sub> , P <sub>f</sub> = 10 mW | A     |               |      | 1    |
| V <sub>c</sub> | Cooler Voltage, ΔT = 70 - T <sub>set</sub> , P <sub>f</sub> = 10 mW | V     |               |      | 2    |

**ABSOLUTE MAXIMUM RATINGS<sup>1</sup>**

(T<sub>c</sub> = 25°C, unless otherwise specified)

| SYMBOLS          | PARAMETERS                        | UNITS | RATINGS    |
|------------------|-----------------------------------|-------|------------|
| I <sub>F</sub>   | Forward Current of LD             | mA    | 300        |
| V <sub>R</sub>   | Reverse Voltage of LD             | V     | 2.0        |
| I <sub>F</sub>   | Forward Current of PD             | mA    | 10         |
| V <sub>R</sub>   | Reverse Voltage of PD             | V     | 20         |
| T <sub>c</sub>   | Operating Case Temperature        | °C    | -20 to +70 |
| T <sub>STG</sub> | Storage Temperature               | °C    | -40 to +85 |
| T <sub>SLD</sub> | Lead Soldering Temperature (10 s) | °C    | 260        |

Note:

1. Operation in excess of any one of these parameters may result in permanent damage.

**TYPICAL PERFORMANCE CURVES** (TC = TSET unless otherwise specified)

**LONGITUDINAL MODE**

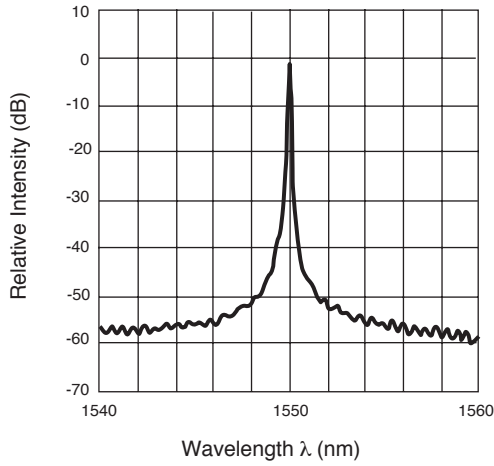

**OPTICAL OUTPUT POWER FROM FIBER vs. FORWARD CURRENT**

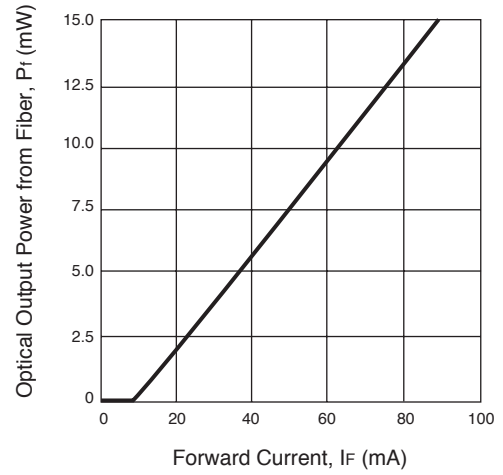

**FORWARD CURRENT vs. FORWARD VOLTAGE**

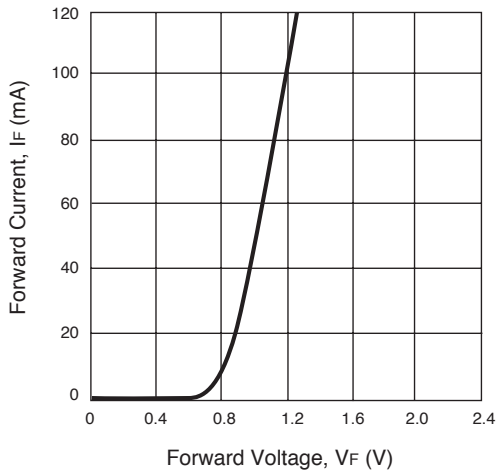

**OPTICAL OUTPUT POWER FROM FIBER vs. MONITOR CURRENT**

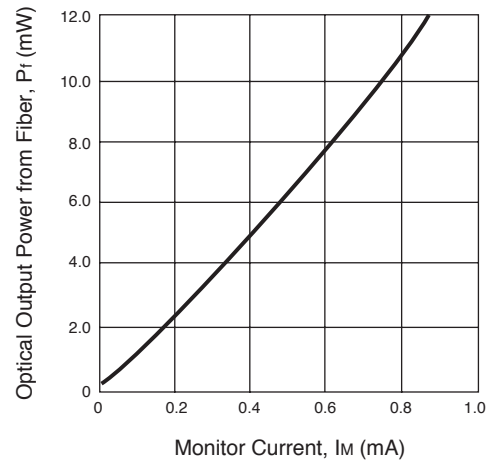

**THERMISTOR RESISTANCE vs. AMBIENT TEMPERATURE**

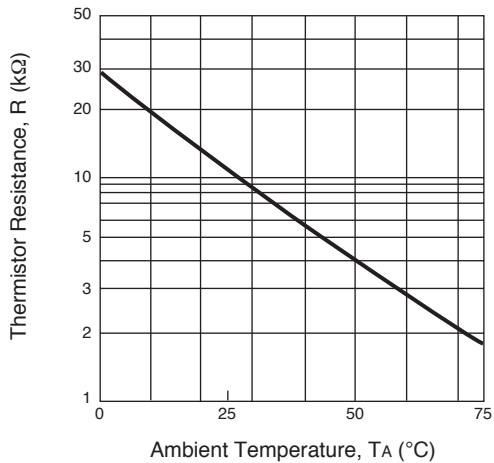

# NX8563 SERIES

## ORDERING INFORMATION

| PART NUMBER | PACKAGE                  |
|-------------|--------------------------|
| NX8563-AZ*  | 14-Pin Butterfly Package |

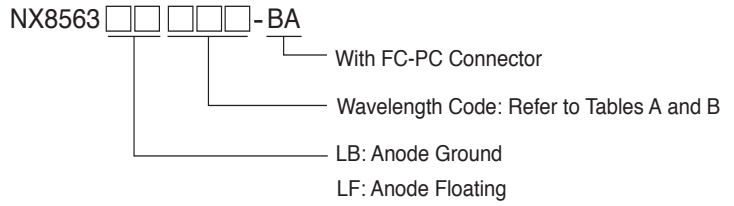

**\*NOTE:**

Please refer to the last page of this data sheet, "Compliance with EU Directives" for Pb-Free RoHS Compliance Information.

**TABLE A: DWDM Wavelength based on ITU-T Recommendations (@T<sub>LD</sub> = Tset)**

| Wavelength code | ITU-T <sup>1</sup> Wavelength (nm) | Frequency (THz) | Wavelength code | ITU-T <sup>1</sup> Wavelength (nm) | Frequency (THz) |
|-----------------|------------------------------------|-----------------|-----------------|------------------------------------|-----------------|
| 287             | 1528.77                            | 196.10          | 493             | 1549.31                            | 193.50          |
| 295             | 1529.55                            | 196.00          | 501             | 1550.11                            | 193.40          |
| 303             | 1530.33                            | 195.90          | 509             | 1550.91                            | 193.30          |
| 311             | 1531.11                            | 195.80          | 517             | 1551.72                            | 193.20          |
| 318             | 1531.89                            | 195.70          | 525             | 1552.52                            | 193.10          |
| 326             | 1532.68                            | 195.60          | 533             | 1553.32                            | 193.00          |
| 334             | 1533.46                            | 195.50          | 541             | 1554.13                            | 192.90          |
| 342             | 1534.25                            | 195.40          | 549             | 1554.94                            | 192.80          |
| 350             | 1535.03                            | 195.30          | 557             | 1555.74                            | 192.70          |
| 358             | 1535.82                            | 195.20          | 565             | 1556.55                            | 192.60          |
| 366             | 1536.60                            | 195.10          | 573             | 1557.36                            | 192.50          |
| 373             | 1537.39                            | 195.00          | 581             | 1558.17                            | 192.40          |
| 381             | 1538.18                            | 194.90          | 589             | 1558.98                            | 192.30          |
| 389             | 1538.97                            | 194.80          | 597             | 1559.79                            | 192.20          |
| 397             | 1539.76                            | 194.70          | 606             | 1560.60                            | 192.10          |
| 405             | 1540.55                            | 194.60          | 614             | 1561.41                            | 192.00          |
| 413             | 1541.34                            | 194.50          | 622             | 1562.23                            | 191.90          |
| 421             | 1542.14                            | 194.40          | 630             | 1563.04                            | 191.80          |
| 429             | 1542.93                            | 194.30          | 638             | 1563.86                            | 191.70          |
| 437             | 1543.73                            | 194.20          | 646             | 1564.67                            | 191.60          |
| 445             | 1544.52                            | 194.10          | 654             | 1565.49                            | 191.50          |
| 453             | 1545.32                            | 194.00          | 663             | 1566.31                            | 191.40          |
| 461             | 1546.11                            | 193.90          | 671             | 1567.13                            | 191.30          |
| 469             | 1546.91                            | 193.80          | 679             | 1567.95                            | 191.20          |
| 477             | 1547.71                            | 193.70          | 687             | 1568.77                            | 191.10          |
| 485             | 1548.51                            | 193.60          |                 |                                    |                 |

**Note:**

1. The Value which omitted and computed the 3rd place below the decimal point.

**TABLE B: DWDM Wavelength based on ITU-T Recommendations (@T<sub>LD</sub> = Tset)**

| Wavelength code | ITU-T <sup>1</sup> Wavelength (nm) | Frequency (THz) | Wavelength code | ITU-T <sup>1</sup> Wavelength (nm) | Frequency (THz) |
|-----------------|------------------------------------|-----------------|-----------------|------------------------------------|-----------------|
| 695             | 1569.59                            | 191.00          | 912             | 1591.25                            | 188.40          |
| 704             | 1570.41                            | 190.90          | 921             | 1592.10                            | 188.30          |
| 712             | 1571.23                            | 190.80          | 929             | 1592.94                            | 188.20          |
| 720             | 1572.06                            | 190.70          | 937             | 1593.79                            | 188.10          |
| 728             | 1572.88                            | 190.60          | 946             | 1594.64                            | 188.00          |
| 737             | 1573.71                            | 190.50          | 954             | 1595.48                            | 187.90          |
| 745             | 1574.54                            | 190.40          | 963             | 1596.33                            | 187.80          |
| 753             | 1575.36                            | 190.30          | 971             | 1597.18                            | 187.70          |
| 761             | 1576.19                            | 190.20          | 980             | 1598.04                            | 187.60          |
| 770             | 1577.02                            | 190.10          | 988             | 1598.89                            | 187.50          |
| 778             | 1577.85                            | 190.00          | 997             | 1599.74                            | 187.40          |
| 786             | 1578.68                            | 189.90          | 6006            | 1600.60                            | 187.30          |
| 795             | 1579.51                            | 189.80          | 6014            | 1601.45                            | 187.20          |
| 803             | 1580.35                            | 189.70          | 6023            | 1602.31                            | 187.10          |
| 811             | 1581.18                            | 189.60          | 6031            | 1603.16                            | 187.00          |
| 820             | 1582.01                            | 189.50          | 6040            | 1604.02                            | 186.90          |
| 828             | 1582.85                            | 189.40          | 6048            | 1604.88                            | 186.80          |
| 836             | 1583.69                            | 189.30          | 6057            | 1605.74                            | 186.70          |
| 845             | 1584.52                            | 189.20          | 6066            | 1606.60                            | 186.60          |
| 853             | 1585.36                            | 189.10          | 6074            | 1607.46                            | 186.50          |
| 862             | 1586.20                            | 189.00          | 6083            | 1608.32                            | 186.40          |
| 870             | 1587.04                            | 188.90          | 6091            | 1609.19                            | 186.30          |
| 878             | 1587.88                            | 188.80          | 6100            | 1610.05                            | 186.20          |
| 887             | 1588.72                            | 188.70          | 6109            | 1610.92                            | 186.10          |
| 895             | 1589.56                            | 188.60          | 6117            | 1611.78                            | 186.00          |
| 4904            | 1590.41                            | 188.50          |                 |                                    |                 |

Note:

1. The Value which omitted and computed the 3rd place below the decimal point.

# NX8563 SERIES

## OUTLINE DIMENSIONS (Units in mm)

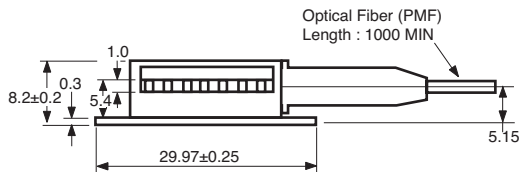
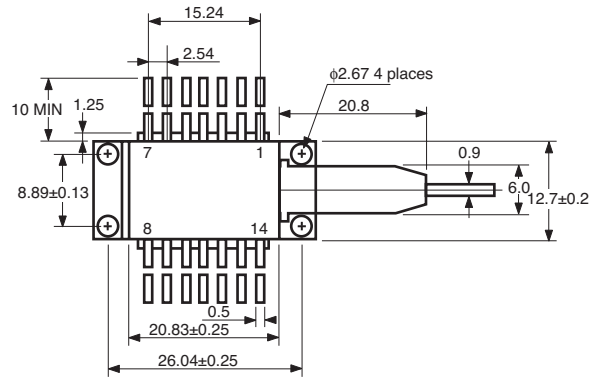

**NX8563LB  
TOP VIEW**

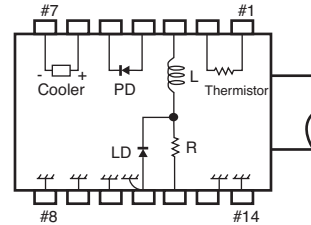

**PIN CONNECTIONS**

| PIN No. | FUNCTION       | PIN No. | FUNCTION      |
|---------|----------------|---------|---------------|
| 1       | THERMISTOR     | 8       | GND           |
| 2       | THERMISTOR     | 9       | GND           |
| 3       | BIAS           | 10      | GND           |
| 4       | PD ANODE       | 11      | GND, LD ANODE |
| 5       | PD CATHODE,    | 12      | SIGNAL INPUT  |
| 6       | COOLER ANODE   | 13      | GND           |
| 7       | COOLER CATHODE | 14      | GND           |

**NX8563LF  
TOP VIEW**

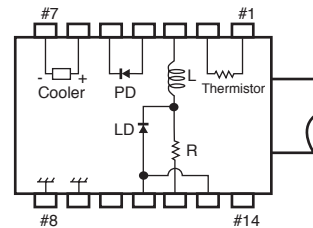

**PIN CONNECTIONS**

| PIN No. | FUNCTION       | PIN No. | FUNCTION                 |
|---------|----------------|---------|--------------------------|
| 1       | THERMISTOR     | 8       | GND                      |
| 2       | THERMISTOR     | 9       | GND                      |
| 3       | LD Cathode     | 10      | PD ( $\lambda_p$ ) ANODE |
| 4       | PD (Pi) ANODE  | 11      | LD ANODE                 |
| 5       | PD CATHODE     | 12      | LD CATHODE               |
| 6       | COOLER ANODE   | 13      | LD ANODE                 |
| 7       | COOLER CATHODE | 14      | NC                       |

## OPTICAL FIBER DIMENSIONS (Units in mm)

| Parameter                    | Unit | Specification |
|------------------------------|------|---------------|
| Outer Diameter               | mm   | 0.9±0.1       |
| Minimum Fiber Bending Radius | mm   | 30            |
| Fiber Length                 | mm   | 1000 MIN      |

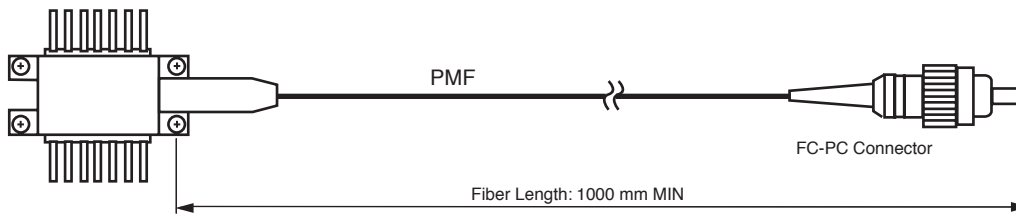

**Life Support Applications**

These NEC products are not intended for use in life support devices, appliances, or systems where the malfunction of these products can reasonably be expected to result in personal injury. The customers of CEL using or selling these products for use in such applications do so at their own risk and agree to fully indemnify CEL for all damages resulting from such improper use or sale.

**CEL California Eastern Laboratories**, Your source for NEC RF, Microwave, Optoelectronic, and Fiber Optic Semiconductor Devices.  
4590 Patrick Henry Drive • Santa Clara, CA 95054-1817 • (408) 988-3500 • FAX (408) 988-0279 • [www.cel.com](http://www.cel.com)

DATA SUBJECT TO CHANGE WITHOUT NOTICE

04/02/2003

Subject: Compliance with EU Directives

CEL certifies, to its knowledge, that semiconductor and laser products detailed below are compliant with the requirements of European Union (EU) Directive 2002/95/EC Restriction on Use of Hazardous Substances in electrical and electronic equipment (RoHS) and the requirements of EU Directive 2003/11/EC Restriction on Penta and Octa BDE.

CEL Pb-free products have the same base part number with a suffix added. The suffix –A indicates that the device is Pb-free. The –AZ suffix is used to designate devices containing Pb which are exempted from the requirement of RoHS directive (\*). In all cases the devices have Pb-free terminals. All devices with these suffixes meet the requirements of the RoHS directive.

This status is based on CEL’s understanding of the EU Directives and knowledge of the materials that go into its products as of the date of disclosure of this information.

| Restricted Substance per RoHS | Concentration Limit per RoHS (values are not yet fixed) | Concentration contained in CEL devices |     |
|-------------------------------|---|--|-----|
|                               |   | -A                                     | -AZ |
| Lead (Pb)                     | < 1000 PPM  | Not Detected                           | (*) |
| Mercury                       | < 1000 PPM  | Not Detected                           |     |
| Cadmium                       | < 100 PPM   | Not Detected                           |     |
| Hexavalent Chromium           | < 1000 PPM  | Not Detected                           |     |
| PBB                           | < 1000 PPM  | Not Detected                           |     |
| PBDE                          | < 1000 PPM  | Not Detected                           |     |

If you should have any additional questions regarding our devices and compliance to environmental standards, please do not hesitate to contact your local representative.

Important Information and Disclaimer: Information provided by CEL on its website or in other communications concerning the substance content of its products represents knowledge and belief as of the date that it is provided. CEL bases its knowledge and belief on information provided by third parties and makes no representation or warranty as to the accuracy of such information. Efforts are underway to better integrate information from third parties. CEL has taken and continues to take reasonable steps to provide representative and accurate information but may not have conducted destructive testing or chemical analysis on incoming materials and chemicals. CEL and CEL suppliers consider certain information to be proprietary, and thus CAS numbers and other limited information may not be available for release.

In no event shall CEL’s liability arising out of such information exceed the total purchase price of the CEL part(s) at issue sold by CEL to customer on an annual basis.

See CEL Terms and Conditions for additional clarification of warranties and liability.